



## **NY Fire Safety Institute**

**Presents the FDNY Certificate of Fitness**

**F-89**

**Fire & Life Safety Director**

**Component 1 Fire**

*Established 1995*

*Preparing the future High Rise Building Fire Safety Directors*

**NY Fire Safety Institute**

**The New Yorker, A Wyndham Hotel**

**481 Eighth Avenue. Suite 618**

**Eighth Avenue and West 34<sup>th</sup> Street**

# Table of Contents

INTRODUCTION OF THE CURRICULUM ..... 3

DEFINITION ..... 4

## PART I. GENERAL TOPICS

Chapter 0.FLS DIRECTOR QUALIFICATIONS AND NOTICES OF EXAMS ..... 15

Chapter 1. COMPREHENSIVE FIRE SAFETY & EMERGENCY ACTION PLAN  
& OWNER OBLIGATIONS ..... 37

Chapter 2. LEGAL REQUIREMENTS ..... 44

Chapter 3. FLS DIRECTOR AND OTHER FLS STAFF DUTIES ..... 48

Chapter 4. FIREMATICS ..... 60

Chapter 5. BUILDING CONSTRUCTION AND PRIMARY FIRE PROTECTION SYSTEMS .. 64

Chapter 6. Other Fire Safety-Related Building Systems..... 121

Chapter 7. OTHER FIRE SAFETY OPERATIONAL & MAINTENANCE REQUIREMENTS . 158

Chapter 8. RECORD KEEPING REQUIREMENTS ..... 175

## PART II. FIRE SAFETY TRAINING

Chapter 9. HISTORY OF FATAL FIRES IN DIFFERENT HIGH-RISE OCCUPANCIES ..... 179

Chapter 10. FIRE DRILL ..... 183

Chapter 11. FLS DIRECTOR RESPONSIBILITIES IN FIRE EMERGENCIES ..... 190

Chapter 12. CASE STUDY: FIRE EMERGENCIES ..... 197

Reference Material ..... 1 to 20

# INTRODUCTION OF THE CURRICULUM

## Required hours and topics of instruction.

Fire Safety and Life (FLS) Director training courses must be organized and conducted to address general topics, fire safety, and non-fire emergencies not less than 31 hours of training. All approved FLS Director Training schools are accredited to provide a complete full FLS Director course but are required to separate the curriculum into TWO major components:

### Component 1: General Topics and Fire Emergency course (minimum 20 hours)

- Part I: General topics, chapter 1 to chapter 8 of the FLSD curriculum
- Part II: Fire safety training, chapter 9 to chapter 12 of the FLSD curriculum

### Component 2: Non-Fire Emergency course (minimum 11 hours)

- Part III: Non-fire emergency safety training, chapter 13 to chapter 17 of the FLSD curriculum
- Part V: On-Site exam information, chapter 20 to chapter 22 of the FLSD curriculum and hands-on demonstrations: (1) elevator emergency operations and (2) fire alarm panel operations, announcements, and warden phones/ two-way communication devices (minimum 2 hours)
- Part IV: Active Shooter and Medical Emergency Preparedness, chapter 18 and chapter 19 of the FLSD curriculum

**(Note:**

- **Any 7-hour Non-Fire Emergencies EAP course issued on or after 03/31/2020 will no longer be recognized by the FDNY.**
- **Starting on 4/1/2019, the 4-hour ASMEP course should not be offered separately, it should be combined with the 7-hour EAP course to become the 11-hour Non-Fire FLSD course.)**

The certified schools must administer a final exam upon the completion of each section which means there are two final exams for the entire 31-hour FLS Director course. The final examinations must not be included toward the minimum number of hours required by the FDNY.

Different candidates may require different components of the FLS Director curriculum:

Candidate Categories	Component(s) of the FLS Director curriculum
Brand new candidates	31- hour FLS Director courses ( or 20-hour and 11-hour courses)
Candidates who failed the FDNY Fire Component CBT twice	20-hour “FLS Director: General Topics and Fire Emergency” course
Candidates who failed the FDNY Non-Fire Component CBT twice	11-hour “FLS Director: Non-Fire Emergencies EAP + ASMEP” courses

## DEFINITIONS

**ALARM NOTIFICATION APPLIANCE.** A fire alarm system component, such as a bell, horn, speaker, light, text display, or vibration device that issues an audible, tactile, and/or visual alert.

**ALARM SIGNAL.** A signal indicating an emergency requiring immediate action, such as a signal indicative of fire.

**ALTERATION.** Any addition to, or modification of, an existing installation or facility, other than any repair made in the ordinary course of maintenance.

**ANNUNCIATOR.** A unit containing one or more indicator lamps, alphanumeric displays, or other equivalent means in which each indication provides status information about a circuit, condition, or location.

**ASSEMBLY AREA.** A designated area outside of a building to which building occupants are directed to report upon implementation of a partial or full evacuation in accordance with a Comprehensive Fire Safety and Emergency Action Plan or a fire and emergency preparedness plan.

**AUTOMATIC.** As applied to fire protection devices, any device, equipment or system that initiates system function as a result of a predetermined temperature rise, rate of temperature rise, or combustion products, without the necessity for human intervention.

**BUILDING.** An enclosed structure designed or occupied to house any use or occupancy.

**BUILDING OCCUPANTS.** All persons in the building, including employees, building staff, and visitors.

**CENTRAL STATION.** A facility that receives alarm signals from a protected premises and retransmits or otherwise reports such alarm signals to the department.

**CERTIFICATE OF APPROVAL.** A written statement issued by the commissioner, certifying that an article, device or equipment, or type, class, or kind thereof, has been examined, tested, and approved for a specific purpose or use in conformity with the requirements of the construction codes, this code, or the rules.

**CERTIFICATE OF FITNESS.** A written statement issued by the commissioner certifying that the person to whom it is issued has passed an examination as to his or her qualifications or is otherwise deemed qualified to perform one or more of the following duties, for which such certificate is required by this code or the rules:

supervise a facility; conduct or supervise an operation; supervise the storage, handling, and/or use of a material; or conduct or supervise emergency planning and preparedness activities.

**CERTIFICATE OF OPERATION.** A written statement issued by the commissioner approving the operation of a central station, for which such certificate is required by this code or the rules, or the construction codes.

**CERTIFICATE OF QUALIFICATION.** A written statement issued by the commissioner certifying that the person to whom it is issued has passed an examination as to his or her qualifications to direct, control, and supervise the operation of a refrigerating system, for which such certificate is required by this code or the rules.

**CITYWIDE STANDARD KEY.** A key of special or controlled design, also known as a “2642” key, approved by the commissioner which serves to operate elevator emergency recall and emergency in-service operation service switches and other devices or locks as required by the construction codes, including the Building Code, this code, or the rules.



**COMBUSTIBLE LIQUID.** For purposes of transportation, a combustible liquid, as defined in the regulations of the United States Department of Transportation, as set forth in 49 CFR Section 173.120. For all other purposes, a liquid, other than a compressed gas or cryogenic fluid, having a closed cup flash point at or above 100°F (38°C), classified as follows:

**Class II.** Liquids having a closed cup flash point at or above 100°F (38°C) and below 140°F (60°C).

**Class IIIA.** Liquids having a closed cup flash point at or above 140°F (60°C) and below 200°F (93°C).

**Class IIIB.** Liquids having closed cup flash points at or above 200°F (93°C).

**COMBUSTIBLE WASTE.** Any substance, item, or other organic or inorganic matter that presents a fire hazard and is a byproduct or residue of the construction, use, or occupancy of any premises or any activity conducted thereon that has no economic value in connection with such use or occupancy. A combustible waste that has economic value in connection with the use and occupancy of such premises shall be deemed to be a combustible material.

**COMMERCIAL COOKING APPLIANCES.** Appliances used in a commercial food service establishment

for heating or cooking food and which produce grease vapors, steam, fumes, smoke, or odors that are required to be removed through a local exhaust ventilation system. Such appliances shall include deep fat fryers; upright broilers, griddles, broilers, steam-jacketed kettles, hot-top ranges, under-fired broilers (char broilers), ovens, barbecues, rotisseries, and similar appliances. For the purpose of this definition, a food service establishment shall include any building or structure used for the preparation and serving of food, other than commercial cooking appliances in carts or other mobile stands operated by street vendors.

**COMMERCIAL COOKING EXHAUST SYSTEM SERVICING COMPANY CERTIFICATE.**

A certificate issued by the commissioner to a person engaged in the business of inspecting and cleaning commercial cooking equipment exhaust systems, which authorizes such person to inspect and clean commercial cooking equipment exhaust systems, for which such certificate is required by this code or the rules.

**COMMERCIAL COOKING SYSTEM.** A system consisting of commercial cooking equipment, exhaust hood, filters, exhaust duct system, fire extinguishing system, and other related appurtenances designed to capture grease-laden cooking vapors.

**CONSTRUCTION SITE.** Any location at which a building, structure, premises or facility is undergoing construction, alteration, or demolition.

**COVERED MALL.** A Group M building housing separate mercantile tenant spaces and/or other similar occupancies and a common pedestrian area (which may include atrium spaces) that provides access to the main public entrances to such tenant spaces and/or occupancies. A covered mall does not include an exterior perimeter building or tenant space (commonly referred to as an anchor store or anchor building) with direct pedestrian access to the covered mall, provided that such building or tenant space has a lawful means of egress independent of the covered mall.

**DECORATION.** Any item that is used for acoustical, aesthetic, or artistic enhancement of an interior space, including artwork, banners, curtains, draperies, decorative greens, fabrics, hangings, and streamers, but not including acoustical materials regulated by the Building Code as an interior finish.

**DESIGN AND INSTALLATION DOCUMENTS.** Plans and specifications, or other written, graphic and pictorial documents or submissions, setting forth the location, design, arrangement, and physical characteristics of the device, equipment, system, operation, or facility for which approval by the commissioner is sought.

**DISPENSING.** The pouring or transferring by other means of any material from a container, tank or similar vessel, which would release dusts, fumes, mists, vapors, or gases to the atmosphere, unless such release is prevented by a device, equipment, or system designed for that purpose.

**DOTn.** United States Department of Transportation.

**DOTy.** United States Department of Treasury.

**EMERGENCY ALARM SYSTEM.** A system to provide indication and warning of an emergency condition involving a release of hazardous materials or other hazardous material incident.

**EMERGENCY ESCAPE AND RESCUE OPENING.** An operable window, door or other similar device that provides for a means of escape and access for rescue in the event of an emergency.

**EMERGENCY SHELTER.** The temporary use and occupancy of a premises, or part thereof, including but not limited to armories, auditoriums, community centers, gymnasiums, houses of worship, and schools, that are not designed to be occupied for emergency housing, but are authorized by the Department of Buildings to be operated and/or occupied for such purposes for more than fifteen persons for more than 30 consecutive days.

**EMERGENCY SHUTOFF VALVE.** A valve designed to shut off the flow of gases or liquids.

**EMERGENCY SHUTOFF VALVE, AUTOMATIC.** A fail-safe self-closing valve designed to shut off the flow of liquids or gases upon activation of the valve's control system by automatic means.

**EMERGENCY SHUTOFF VALVE, MANUAL.** A manually operated valve designed to shut off the flow of liquids or gases.

**EVACUATION.** The emptying of a building or part thereof of building occupants in response to a fire or nonfire emergency.

**EXIT.** That portion of a means of egress system which is separated from other interior spaces of a building or structure by fire-resistance-rated construction and opening protectives as required to provide a protected path of egress travel between the exit access and the exit discharge. Exits include vertical exits, exterior exit doors at the level of exit discharge, vertical exit enclosures, exit passageways, exterior exit stairs, exterior exit ramps, and horizontal exits, but do not include access stairways, aisles, exit access doors opening to corridors, or corridors.

This term shall include the locations on a premises at which egress may be had from an enclosed outdoor space.

**EXIT ACCESS.** That portion of a means of egress system that leads from any occupied portion of a building, structure or premises to an exit.

**EXIT DISCHARGE.** That portion of a means of egress system between the termination of an exit and a public way.

**EXIT DISCHARGE, LEVEL OF.** The story at the point at which an exit terminates and an exit discharge begins.

**EXPLOSION.** An effect produced by the sudden violent expansion of gases, whether or not accompanied by a shock wave or disruption, of enclosing materials, including the effects of the following sources of explosion:

1. Chemical changes such as rapid oxidation, deflagration or detonation, decomposition of molecules, and runaway polymerization (usually detonations).
2. Physical changes such as pressure tank ruptures.
3. Atomic changes (nuclear fission or fusion).

**EXPLOSIVE.** A chemical compound, mixture or device, the primary or common purpose of which is to function by explosion. The term includes, but is not limited to, dynamite, black powder, pellet powder, initiating explosives, detonators, safety fuses, squibs, detonating cord, igniter cord and igniters.

**FACILITY.** Any premises subject to a design or installation requirement of this code, or at, in or upon which a material regulated by this code is manufactured, stored, handled, used, or transported or an operation regulated by this code is conducted.

**FAIL-SAFE.** A feature of the design of a device, equipment or system that automatically counteracts the effect of an anticipated possible source of failure, or prevents or mitigates a hazardous condition by automatically compensating for a failure or malfunction of the device, equipment or system.

**FEP.** Fire and emergency preparedness.

**FEP STAFF.** The individuals identified in a fire and emergency preparedness plan as responsible for the implementation of such plan, including but not limited to FEP coordinators.

**FIRE.** A rapid, persistent chemical reaction that releases heat and light, especially the burning of a combustible substance in the presence of oxygen. For purposes of this code, a flame used in any lawful, properly operating device, equipment, or system or other controlled setting shall not be considered a fire.

**FIRE ALARM BOX, MANUAL.** A manually operated device used to initiate an alarm signal.

**FIRE ALARM SIGNAL.** A signal initiated by a fire alarm-initiating device such as a manual fire alarm box, automatic fire detector, water-flow switch, or other device whose activation is indicative of the presence of a fire or fire signature.

**FIRE ALARM SYSTEM.** Any system, including any interconnected fire alarm sub-system, of components and circuits arranged to monitor and annunciate the status of fire alarm or supervisory signal-initiating devices.

**FIRE APPARATUS ACCESS ROAD.** A road that serves to provide access for fire apparatus from a public street to the frontage space of one or more buildings not directly fronting on a public street. A fire apparatus access road includes any road that serves such purpose whether denominated as a driveway, parking lot lane, private road, or private street.

**FIRE AREA.** The aggregate floor area enclosed and bounded by fire walls, fire barriers, exterior walls, and/or horizontal assemblies of a building. Areas of the building not provided with surrounding walls shall be included in the fire area if such areas are included within the horizontal projection of the roof or floor next above.

**FIRE COMMAND CENTER.** The principal attended or unattended location where the status of the detection, alarm communications, and control systems is displayed and from which the system(s) can be manually controlled.

**FIRE DEPARTMENT STANDARD KEY.** A key of special or controlled design, also known as a “1620” key, for the use of department personnel and others specifically authorized by the commissioner, which serves to operate all switches, locks, and other devices required to be operable by a citywide standard key.

**FIRE DETECTOR, AUTOMATIC.** A device designed to detect the presence of a fire signature and to initiate action.

**FIRE DRILL.** A training exercise by which building occupants are familiarized with and/or practice the procedures for the safe, orderly, and expeditious sheltering in place, in-building relocation, partial or full evacuation, or any combination thereof, in the event of a fire, in accordance with the emergency preparedness plan for the premises.

**FIRE EXTINGUISHING SYSTEM.** An approved system of devices and equipment which detects a fire and discharges an approved fire extinguishing agent onto or in the area of a fire. Such term includes automatic systems and, where such systems are authorized by this code or the Building Code, manually activated systems.

**FIRE GUARD.** A person holding a certificate of fitness for such purpose, who is trained in and responsible for maintaining a fire watch.

**FIRE LANE.** A public or private road, roadway lane, parking lot lane, or other surface designed to allow vehicular access that has been specifically designated by means of signs or roadway markings as a priority thoroughfare for fire apparatus.

**FIRE PROTECTION SYSTEM.** Approved devices, equipment, and systems or combinations of systems used

to detect a fire, activate an alarm, extinguish or control a fire, control or manage smoke and products of a fire, or any combination thereof, including fire extinguishing systems, fire alarm systems, sprinkler systems, and standpipe systems.

**FIRE-RETARDANT COATING.** An approved coating that, when applied to the surface of scenery in an approved manner, imparts flame resistance and reduces flame spread.

**FIRE WATCH.** A temporary measure intended to ensure continuous and systematic surveillance of a building or portion thereof by one or more qualified individuals for the purposes of identifying and controlling fire hazards, including detecting early signs of fire, raising an alarm of fire, notifying the department, and performing such other fire safety duties as may be prescribed by the commissioner.

**FLAME-RESISTANT MATERIAL.** Material that meets the flame propagation performance criteria of NFPA

701, either because it is inherently flame-resistant or because it has been subjected to a flame-retardant treatment.

**FLAME-RETARDANT TREATMENT.** An approved chemical that, when applied to a material in an approved manner, imparts flame resistance to a material.

**FLAME SPREAD.** The propagation of flame over a surface.

**FLAMMABLE GAS.** A material which has a boiling point and becomes a gas at 68°F (20°C) or less at 14.7 pounds per square inch absolute (psia) (101 kPa) of pressure which:

1. Is ignitable at 14.7 psia (101 kPa) when in a mixture of 13 percent or less by volume with air, in accordance with testing procedures set forth in ASTM E 681; or

2. Has a flammable range at 14.7 psia (101 kPa) with air of at least 12 percent, regardless of the lower explosive limit, in accordance with testing procedures set forth in ASTM E 681.

**FLAMMABLE LIQUID.** For purposes of transportation, a flammable liquid defined in the regulations of the United States Department of Transportation, as set forth in 49 CFR Section 173.120. For all other purposes, a liquid, other than a compressed gas or cryogenic fluid, having a closed cup flash point below 100°F (38°C), classified as follows:

**Class IA.** Liquids having a flash point below 73°F (23°C) and having a boiling point below 100°F (38°C).

**Class IB.** Liquids having a flash point below 73°F (23°C) and having a boiling point at or above 100°F (38°C).

**Class IC.** Liquids having a flash point at or above 73°F (23°C) and below 100°F (38°C).

**FLASH POINT.** The minimum temperature in degrees Fahrenheit at which a liquid will give off sufficient vapors to form an ignitable mixture with air near the surface or in the container, but will not sustain combustion. The flash point of a liquid shall be determined by appropriate test procedure and apparatus as specified in ASTM D 56, ASTM D 93, or ASTM D 3278.

**FLS.** Fire and life safety.

**FLS STAFF.** The individuals required to implement a Comprehensive Fire Safety and Emergency Action Plan, as identified in such plan, including but not limited to the FLS director, deputy FLS director, members of the FLS brigade, and any staff designated as critical operations staff.

**FUMIGANT.** A substance which by itself or in combination with any other substance emits or liberates a gas, fume or vapor utilized for the destruction or control of insects, rats or other vermin or fungi, germs or similar conditions, as distinguished from insecticides and disinfectants which are essentially effective in the solid or liquid phases. Examples are methyl bromide, ethylene dibromide, hydrogen cyanide, carbon disulfide and sulfuryl fluoride.

**FUMIGATION.** The utilization within an enclosed space of a fumigant in concentrations that are hazardous or acutely toxic to humans.

**FUMIGATION AND INSECTICIDAL FOGGING OPERATION COMPANY**

**CERTIFICATE.** A certificate issued by the commissioner to a person engaged in the business of fumigation and insecticidal fogging operations, which authorizes an owner or principal of such business to conduct such fumigation and insecticidal fogging operations, for which such certificate is required by this code or the rules.

**GENERAL SUPERVISION.** Except as otherwise provided in this code, supervision by the holder of any department certificate who is responsible for performing the duties set forth in FC113.2 but need not be personally present on the premises at all times.

**HANDLING.** The movement of a material in its container, the removal of the material from its container, or any other action or process that may affect the material, other than its storage or use.

**HIGH-RISE BUILDING.** Any building designed or constructed in accordance with the 1968 Building Code, any prior Building Code, or other applicable laws, rules, and regulations that is more than six stories or 75 feet (22 860 mm) in height, and any building designed or constructed in accordance with the Building Code that has one or more occupied floors more than 75 feet (22 860 mm) above the lowest level of fire department vehicle apparatus access.

**HIGH-RISE FLOOR.** Any occupied floor in a high-rise building that is at or above the height that causes such building to be classified as a high-rise building.

**HOOD.** An air-intake device used to capture by entrapment, impingement, adhesion, or similar means, grease and similar contaminants before they enter a duct system.

**Type I.** A kitchen hood for collecting and removing grease vapors and smoke.

**HOT WORK.** Cutting, welding, thermit welding, brazing, soldering, grinding, thermal spraying, thawing pipe, cadwelding, installation, of torch-applied roof systems or any other similar operation or activity.

**HOT WORK AREA.** The area exposed to sparks, hot slag, radiant heat, or convective heat as a result of hot work.

**HOT WORK EQUIPMENT.** Electric or gas welding or cutting equipment used for hot work.

**HOT WORK PROGRAM.** A program, implemented by a responsible person designated by the owner of a building or structure in or on which hot work is being performed, to oversee and issue authorizations for such hot work for the purpose of preventing fire and fire spread.

**HOT WORK PROGRAM AUTHORIZATIONS.** Authorizations issued by the responsible person under a hot work program allowing welding or other hot work to be performed at the premises.

**IMPAIRMENT COORDINATOR.** The person responsible for ensuring that proper safety precautions are taken when a fire protection system is out of service.

**IN-BUILDING RELOCATION.** The controlled movement of building occupants from an endangered area of a building to an in-building relocation area within the same building in response to a fire or non-fire emergency.

**IN-BUILDING RELOCATION AREA.** A designated area in a building to which building occupants may be relocated in accordance with the emergency preparedness plan for the premises.

**INITIATING DEVICE.** A system component that originates transmission of a change-of-state condition, such as in a smoke detector, manual fire alarm box, or supervisory switch.

**INSECTICIDAL FOGGING.** The utilization of insecticidal liquids passed through fog-generating units where, by pressure and turbulence, and with or without addition of heat, such liquids are transformed and discharged in the form of fog or mist blown into an area to be treated.

**INTERIOR FINISH.** Construction materials that form the exposed interior surfaces of a building and that are part of or affixed to walls, fixed or folding partitions, ceilings, and other construction elements.

**KEY BOX.** A secure device with a lock operable only by a citywide standard key or other approved key.

**LARGE-AREA BUILDING.** A building that is not a high-rise building but is either a Group B office building within the meaning of Section 907.2.2.2 of the Building Code that has a total gross area of more than 100,000 square feet (9290 m<sup>2</sup>) or a building of an occupancy type other than Group R-2 or Group R-3 that has a total gross area of more than 100,000 square feet (9290 m<sup>2</sup>).

**MEANS OF EGRESS.** A continuous and unobstructed path of vertical and horizontal egress travel from any occupied portion of a building, structure, or premises to a public way. A means of egress consists of three separate and distinct parts: the exit access, the exit, and the exit discharge.

**MIXED-OCCUPANCY BUILDING.** A building or structure housing more than one occupancy or type of occupancy required by this chapter to prepare an emergency preparedness plan.

**MULTIPLE-STATION ALARM DEVICE.** Two or more single-station alarm devices that can be

interconnected such that actuation of one causes all integral or separate audible alarms to operate. It also can consist of one single-station alarm device having connections to other detectors or to a manual fire alarm box.

**NATURAL DECORATIVE GREEN.** A bough of a natural tree or part thereof.

**NATURAL TREE.** Any live tree, plant, or shrub, including conifer, that is rooted in soil.

**NON-FIRE EMERGENCY.** A biological, chemical or nuclear incident or release; declaration of emergency by a lawful authority; explosion; medical emergency; natural disaster; or other emergency affecting the premises or the safety of building occupants.

**NON-FIRE EMERGENCY DRILL.** A training exercise by which building occupants are familiarized with and/or practice the procedures for safe, orderly, and expeditious sheltering in place, in-building relocation, partial or full evacuation, or combination thereof, in the event of a non-fire emergency, in accordance with the emergency preparedness plan for the premises.

**OFFICE BUILDING.** A Group B occupancy designed and arranged to provide offices and other areas for the conduct of business ordinarily conducted in offices.

**OCCUPANCY.** The purpose or activity for which a building or space is used or designed to be used. References to occupancy classification shall be deemed to include the equivalent occupancy classifications under the 1968 Building Code and all prior Building Codes or other applicable laws, rules and regulations.

The 1968 Building Code classified the buildings into 9 categories and the 2008 Building Code classified the new buildings into 10 categories using different letter designations. The categories are listed below:

<b>Occupancy groups</b>	<b>1968 Building Code</b>	<b>2008/2014 Building Code</b>
<b>Assembly</b>	<b>F</b>	<b>A</b>
<b>*Business</b>	<b>E</b>	<b>B</b>
<b>Educational</b>	<b>G</b>	<b>E</b>
<b>Factory and Industrial</b>	<b>D</b>	<b>F</b>
<b>High Hazard</b>	<b>A</b>	<b>H</b>
<b>Institutional</b>	<b>H</b>	<b>I</b>
<b>Mercantile</b>	<b>C</b>	<b>M</b>
<b>Occupancy groups</b>	<b>1968 Building Code</b>	<b>2008/2014 Building Code</b>
<b>Residential</b>	<b>J</b>	<b>R</b>
<b>Hotels</b>	<b>J-1</b>	<b>R-1</b>
<b>Apartment Buildings</b>	<b>J-2</b>	<b>R-2</b>
<b>Storage</b>	<b>B</b>	<b>S</b>
<b>Utility and Miscellaneous</b>	<b>N/A</b>	<b>U</b>

\*Business buildings may include banks, civic administration buildings, office spaces, neighborhood family care centers, medical offices, adult educational facilities (above 12<sup>th</sup> grade).

**OFFICE BUILDING.** A Group B occupancy designed and arranged to provide offices and other areas for the conduct of business ordinarily conducted in offices.

**OUT-OF-SERVICE SYSTEM.** A fire protection system that is not fully functional, or whose operation is impaired or is otherwise not in good working order.

**OVERCROWDING.** A condition that exists when: (1) the number of occupants present in any premises or part thereof exceeds (a) the maximum number of occupants specified for such premises or part thereof by the certificate of occupancy or other authorization issued by the Department of Buildings; or (b) in the absence of such certificate or authorization, the maximum number of occupants established by using the applicable occupant-area allowances set forth in Section 1004.1 of the Building Code; or (c) with respect to a rooftop place of assembly or place of public gathering, the number of occupants present in any such place exceeds one person per 10 square feet (0.929 m<sup>2</sup>) of the rooftop area to be used for such purpose; or (2) the commissioner determines that a threat exists to the safety of the occupants of any premises or part thereof by reason of the number of persons on the premises and/or the presence of persons sitting and/or standing in locations that may obstruct or impede access to means of egress, including obstructing or impeding access to aisles, passages, corridors, stairways, or exits.

**OWNER.** The owner of the freehold of any real property (as defined in section two of the Real Property Law), or of a lesser estate therein, a mortgagee or vendee in possession, assignee of rents, receiver, executor, trustee, lessee, agent, or any other person, firm, or corporation, directly or indirectly in control of real property. Any reference in this code to the owner of any building, structure, or premises shall be deemed to designate collectively any and all of the foregoing, including, but not limited to, the owner of the freehold or lesser estate therein and a managing agent designated by such owner pursuant to Section 27-2098 of the New York City Administrative Code.

**REFRIGERANT.** The fluid used for heat transfer in a refrigerating system; the refrigerant absorbs heat and transfers it at a higher temperature and a higher pressure, usually with a change of state.

**REFRIGERATING SYSTEM.** A combination of interconnected refrigerant-containing parts constituting one closed refrigerant circuit in which a refrigerant is circulated for the purpose of extracting then expelling heat.

**REGULAR BUSINESS HOURS.** Times of day and days of the week during which a building or occupancy is normally occupied and business is conducted, and any time when a building or occupancy required to have a Comprehensive Fire and Emergency Action Plan is occupied by more than five hundred persons or more than one hundred persons above or below the street level. The number of persons employed in a building or occupancy during regular business hours shall be computed based on the work shift or other regular work schedule during which the largest number of employees or other persons working at the premises are present at the premises.

**PERMIT.** A written statement issued by the commissioner authorizing the manufacture, storage, handling, use, or transportation of a hazardous material, or other material, or to conduct an operation or to maintain a facility, for which a permit is required by this code.

**PERSONAL SUPERVISION.** Except as otherwise provided in this code, supervision by the holder of any department certificate who is required to be personally present on the premises, or other proximate location acceptable to the department, while performing the duties for which the certificate is required.

**PORTABLE FIRE EXTINGUISHER SALES COMPANY CERTIFICATE.** A certificate issued by the



commissioner to a person engaged in the business of selling portable fire extinguishers door to door to owners of buildings or business for use on their premises, which authorizes such person to engage in such business and supervise such sales.

**PORTABLE FIRE EXTINGUISHER SERVICING COMPANY CERTIFICATE.** A certificate issued by

the commissioner to a person engaged in the business of servicing portable fire extinguishers, which authorizes such person to engage in such business and supervise the provision of such servicing by certificate of fitness holders.

**PRESIGNAL SYSTEM.** A fire alarm system having a feature that allows initial fire alarm signals to sound in a constantly attended central location and for which a human action is subsequently required to achieve a general alarm, or a feature that allows the control equipment to delay the general alarm by more than one minute after the start of the alarm processing.

**PROTECTED PREMISES.** A building, occupancy, or structure located in the city that is equipped with a fire alarm system that transmits an alarm signal to the department or a central station that monitors such system for the purposes of reporting fire alarms to the department, whether or not the installation of such system on the premises is required by law.

**RESPONSIBLE PERSON.** A person trained in the fire safety hazards associated with hot work and in the necessary and appropriate measures to minimize those hazards who is designated by the owner of a premises to authorize the performance of hot work at the premises.

**RUBBISH.** Combustible and noncombustible waste materials, including dust, dirt, ashes, rags, paper, cartons, cans, plastic, and glass containers, and discarded appliances.

**SCENERY.** Any or all of those devices ordinarily used on a stage in the presentation of a theatrical, artistic, musical, or other similar live performance, such as back drops, side tabs, teasers, borders or scrim, rigid flats, set pieces, and all properties, except costumes.

**SHELTER IN PLACE.** The precaution of directing building occupants to remain indoors, at their present location, in response to a fire or non-fire emergency.

**SINGLE-STATION SMOKE ALARM.** An assembly incorporating the detector, the control equipment, and the alarm-sounding device in one unit, operated from a power supply either in the unit or obtained at the point of installation.

**SMOKE ALARM.** A single- or multiple-station alarm responsive to smoke and not connected to a system.

**SMOKE DETECTOR.** A listed device that senses visible or invisible particles of combustion.

**SMOKE**

**DETECTOR MAINTENANCE COMPANY CERTIFICATE.** A certificate issued by the commissioner to a

person engaged in the business of performing smoke detector cleaning and testing, which authorizes such person to engage in such business and supervise the performance of such cleaning and testing by certificate of fitness holders.

**SPRINKLER SYSTEM.** A fire extinguishing system, other than a mist fire extinguishing system, that utilizes water as the extinguishing agent.

**STANDPIPE, MULTI-ZONE.** standpipe system that is vertically subdivided as required by the construction codes, including the Building Code, into zones to limit the maximum operating pressure in the system. Each zone will have its own individual automatic water supply.

**STANDPIPE SYSTEM.** Piping installed in a building or structure that serves to transfer water from a water supply to hose connections at one or more locations in a building or structure used for firefighting purposes.

**STRUCTURE.** Any construction on, above or below real property, including buildings, enclosures, sheds, and tents.

**SUPERVISORY SIGNAL.** A signal indicating the need for action in connection with the supervision of guard tours, fire extinguishing systems or equipment, fire alarm systems, or the maintenance features of related systems.

**SUPERVISORY SIGNAL-INITIATING DEVICE.** An initiating device, such as a valve supervisory switch, water level indicator, or low-air pressure switch on a dry-pipe sprinkler system, that triggers a supervisory signal.

**TORCH-APPLIED ROOF SYSTEM.** Bituminous roofing systems using membranes that are adhered by heating with a torch and melting asphalt back coating instead of mopping hot asphalt for adhesion.

**TROUBLE SIGNAL.** A signal initiated by the fire alarm system or device indicative of a fault in a monitored circuit or component.

**UNNECESSARY ALARM.** An alarm signal transmitted by a fire alarm system which functioned as designed, but for which a department response proved unnecessary. An example of an unnecessary alarm is an alarm triggered by smoke from a lit cigarette in a non-smoking area, when the presence of such smoke does not implicate fire safety concerns.

**UNWARRANTED ALARM.** An alarm signal transmitted by a fire alarm system which failed to function as designed as a result of improper installation, improper maintenance, malfunction, or other factor. Examples of unwarranted alarms are alarms resulting from improper smoke detector placement, improper detector setting for installed location, lack of system maintenance, and control panel malfunction.

**VOICE COMMUNICATION CAPABILITY.** The ability to communicate to the occupants of a building or occupancy by means of a fire alarm system with one-way or two-way voice communication.

# PART I. GENERAL TOPICS

## Chapter 0. FLS DIRECTOR QUALIFICATIONS AND NOTICES OF EXAMS

### 0.1 Qualifications.

- Be at least 18 years of age, or such age above the age of 18 as may be required by law, rule, or regulation.
- Have a reasonable understanding of the English language and be able to answer satisfactorily such questions as may be asked of such applicant upon his or her examination.
- Present such evidence of his or her character, habits, and past employment, as may be satisfactory to the commissioner.
- Have at least three (3) years' full-time work experience in one or more of the following fields (in any combination thereof), OR 18 months' full-time work experience in one or more of the following fields (in any combination thereof) that includes at least six (6) months of continuous employment at one work location:
  - firefighting or other public safety emergency response employment;
  - any fire safety-related employment, including code enforcement, fire safety inspection, fire prevention, or emergency preparedness;
  - the design, installation, operation or maintenance of building fire protection, electrical, plumbing, heating, ventilation, or air conditioning systems, or other building system regulated by the construction codes; or
  - equivalent experience acceptable to the Department;

(examples are listed on the following pages)

- Successfully complete the *FLS* Director training course approved by the FDNY.
- Pass FDNY required written and on-site examinations.
- Be physically able to perform the duties of the position, if in doubt, contact the Certificate of Fitness Unit prior to scheduling the FLS Director exams.
- Applicants are prohibited from being employed by any FDNY- approved FLS Director School for at least four (4) years after taking the FLS Director written and on-site exams.

#### **0.1.1 Qualification Criteria for FLS Director**

Applicants must have at least three (3) years' full-time work experience in one or more of the following fields (in any combination thereof), OR 18 months' full-time work experience in one or more of the following fields (in any combination thereof) that includes at least six (6) months of continuous employment at one work location:

**Fire Fighter, Fire Inspector, Fire Marshall, Correction Officer, Police Officer, Volunteer Fire Fighter Acceptable Experience:**

1. as a Firefighter, Fire Inspector, Fire Marshall, Police Officer, Volunteer Firefighter, Correction Officer in any country

*Required Documentation:*

1. letter from Personnel Director including service dates;
2. any relevant certificate or license

**Building Maintenance Personnel (e.g. engineers, Class E or J-1 Building Superintendent, etc.)**

Acceptable Experience:

1. maintenance and inspection of sprinkler/standpipe systems with required C of F (S-12/S-13/S-14); or
2. inspection, testing, and servicing of fire alarm systems with required C of F (S-97/S-98, S-95); or
3. maintenance and inspection of smoke detectors with required C of F (F-78/S-78) ; or
4. the design, installation, operation, or maintenance of building fire protection, electrical, plumbing, heating, ventilation, or air conditioning systems, or other building system with required C of F (Q-01/Q-99) or other qualified DOB licenses (Master Plumbers & Master Fire Suppression Piping Contractor;  
Master Electricians & Special Electricians; High Pressure Boiler Operating Engineer; Oil Burning Equipment Installer)

**Building/Residence/Property Manager**

Acceptable Experience:

1. supervision of building custodians and building maintenance personnel; or
2. development of Fire Safety Plan or Comprehensive Fire Safety and Emergency Action Plan; or
3. develop/implement building fire safety policy; or
4. experience as a building engineer with required C of F (Q-01/Q-99) or other qualified DOB licenses  
(Master Plumbers & Master Fire Suppression Piping Contractor; Master Electricians & Special Electricians; High Pressure Boiler Operating Engineer; Oil Burning Equipment Installer)

**Building Evacuation Supervisor (must be listed on the building Fire Safety Plan or Comprehensive Fire Safety and Emergency Action Plan) Acceptable Experience:**

1. the experience in manning fire command center; or
2. implementation of building Fire Safety Plan or Comprehensive Fire Safety and Emergency Action Plan; or
3. implementation of building fire safety policy

*Required notarized statements:*

From FLSD attesting to training in building evacuation procedures; or

From FLSD attesting to training in the manning of fire command center; or

Copy of the building safety plan including years of claimed experience;

**Floor Warden or Brigade member (must be listed on the building Fire Safety Plan or Comprehensive Fire Safety and Emergency Action Plan) Acceptable Experience:**

1. as member of the Fire Brigade (Floor Warden trained by the EAPD/FLSD)
2. as member of the Emergency Response Team (trained by the FLSD in J-1 Occupancies only)

*Required notarized statements;*

1. copy of the building evacuation plan including years of claimed experience, and
2. from FLSD attesting to training in building evacuation procedures

**Coordinator of Fire Safety and Alarm System in Homeless Shelters**

Acceptable Experience:

1. the experience in operating the fire alarm control panel in a shelter and conducting drills in a shelter with the required Certificate of Fitness (F-80)

**Construction Site Fire Safety Manager or Site Safety Manager**

Acceptable Experience:

1. the experience in conducting inspections of all fire safety measures, and fire protection equipment and systems at a construction site with the required Certificate of Fitness (S-56) to ensure they are readily available and complying with the Fire Code and Building Code.
2. the experience in monitoring construction sites and ensuring the construction company complies with state and federal regulations on safety in the workplace with the required NYC DOB license (Site Safety Manager Certification).

**Note:** The experience of only being a Fire Guard (e.g. F-01/F-02/F-03/F-04/F-36/F-54/F-91, etc.) or a security guard (e.g. S-60 or New York State security license) will **generally NOT QUALIFY** you to become a Fire and Life Safety Director candidate.

**Note:** If you do not meet the qualified titles listed above or are not listed on the Comprehensive Fire Safety and Emergency Action Plan or the Fire Safety and Evacuation Plan, you must address your fire safety-related experience **in detail** for qualification review. The experience must be highly related to the Fire and Life Safety Director duties and/or building fire protection systems with required C of Fs.

## **0.2 Notice of Exam (F-89/T-89)**

### *0.2.1 New candidates*

The certification process of the F-89/T-89 Certificate of Fitness is listed below:

- (1) Training courses requirements
- (2) FDNY FLSD computer based exams
- (3) FDNY on-site exam (F-89/T-89)

The simplified flow chart of certifying process is provided below the detail flowchart is on the following page.

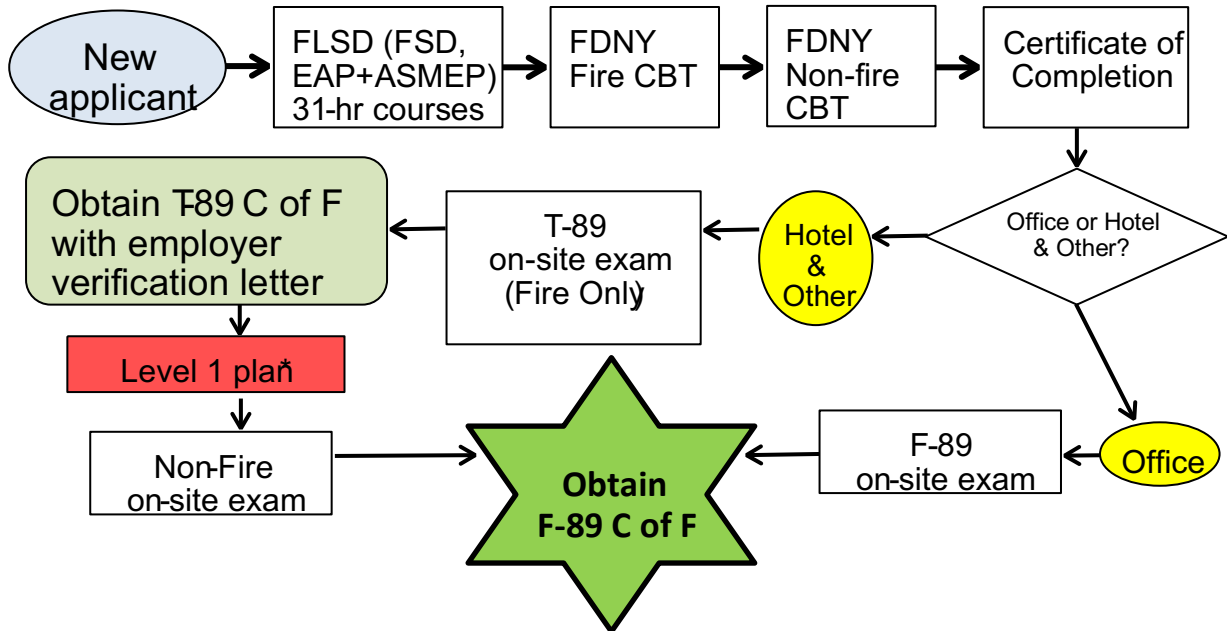

*Candidates who complete the required courses and pass both FDNY fire and non-fire component computer exams but do not meet the qualification criteria listed above will NOT receive the Certificate of Completion and will NOT be able to schedule the FLSD On-Site exam.*

**\* When the building is required to prepare the level 1 plan by the new FDNY rule**

**Flow chart of the procedures for NEW applicants**

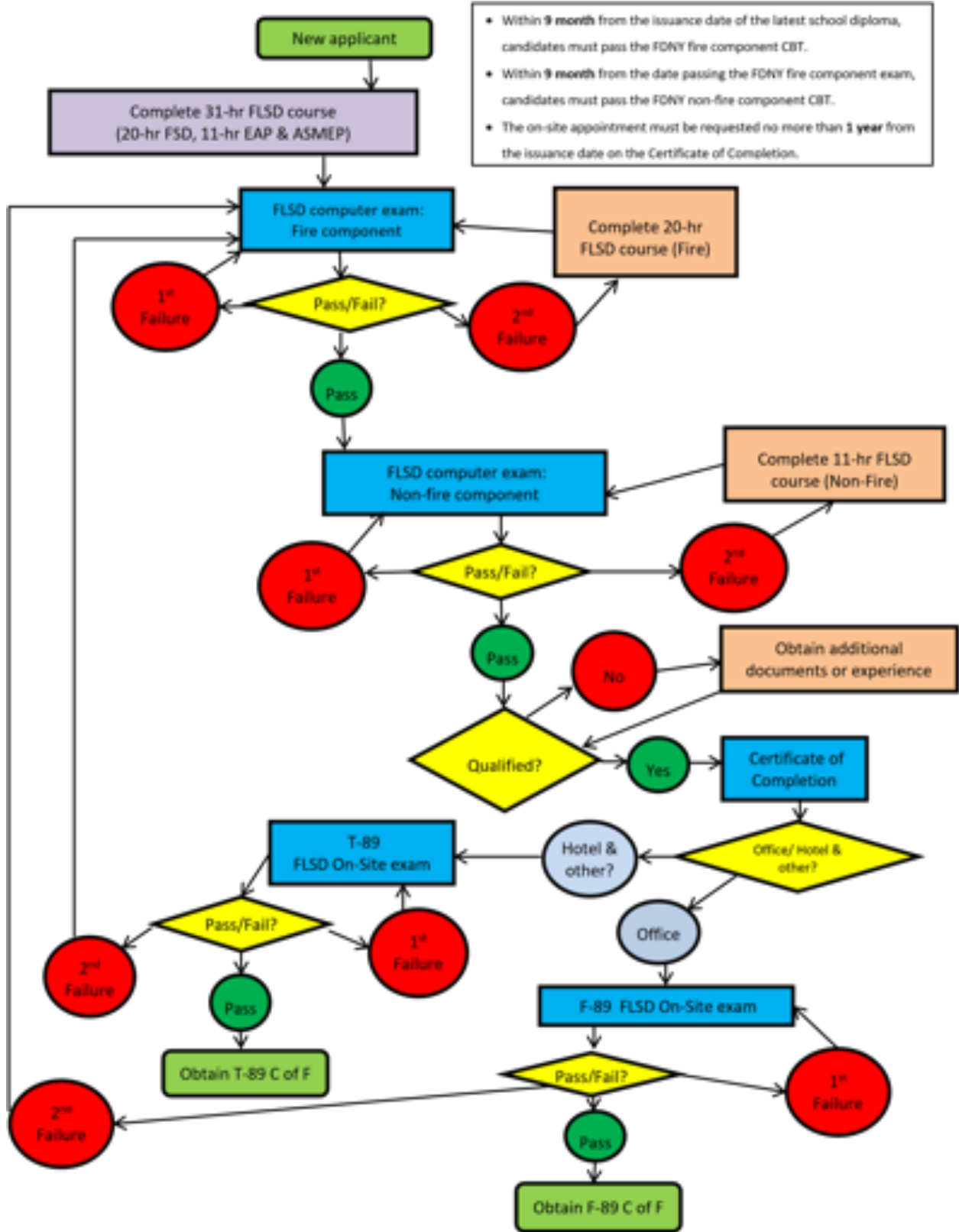

(1) Training courses

All FLS Director candidates must complete the 31-hour FLS Director training course from one of the FDNY certified schools or organizations before taking the two (fire and non-fire) FDNY computer based exams. The list of the FDNY certified schools or organizations can be found on the following link:

<http://www1.nyc.gov/site/fdny/business/all-certifications/approved-schools.page>

The 31-hour FLS Director training courses shall include TWO major components: (1) General Topic and Fire

Emergency course (20 hours); and (2) Non-Fire Emergencies EAP course and ASMEP course (11 hours). New candidates may take two components separately; however, the second course should be completed within 3 months from the date listed on the first course diploma.

Candidates must attend all training classes to be eligible to take the required training course's final examinations for two sections. School Graduation Diploma will be issued after the candidates obtain a passing score of 70% for each final exam. Candidates shall be allowed two (2) opportunities to pass each exam. Candidates who fail the final examination on the second attempt shall be required to re-attend the course in its entirety.

The Graduation Diploma is valid for **9 MONTHS** in order to take the FDNY Fire component computer based exam.

(2) Computer based exams

**Within 9 months** of successfully completing the FLS Director training course, candidates must pass the first FLS Director computer based exam, Fire component, administered by the FDNY.

**Within nine 9 months** of passing the fire component of the FLS Director computer based examination, candidates must pass the second FLS Director computer based exam, Non-Fire emergency Component, administered by the FDNY.

**DATE OF EXAM:**

**An appointment is required to take the N-85/Z-89 Certificate of Fitness Exam.**

Application and payment must be completed online prior to scheduling an appointment. **You must have** an FDNY COF application ID before scheduling the appointment.

**Application and payment must be completed online prior to scheduling an appointment. You must have a COF application ID before scheduling the appointment.**

Instructions for online application and payment can be found here:

<http://www1.nyc.gov/assets/fdny/downloads/pdf/business/fdny-business-cof-individuals-short.pdf>

Create an Account and Log in to:

<http://fires.fdnyccloud.org/CitizenAccess/SAML/NYCIDLogin>

[.aspx](#) To Schedule an appointment:

<http://www1.nyc.gov/site/fdny/business/all-certifications/cof-online-scheduler.page>

Candidates are not allowed to schedule two exams on the same day.

**Quick Reference Guide for FLSD online application**

<https://www1.nyc.gov/assets/fdny/downloads/pdf/business/fdny-business-cof-individuals-short-flsd.pdf>

**FEE:** **Application Fees:** \$25.00 for **each** computer based exam. The application fee must be paid prior to taking the computer based examination. This fee includes the issuance of a Certificate of Completion after passing two FDNY computer based exams (fire and non-fire components). Applicants who fail the computer based examination must pay \$25.00 for each subsequent exam. The fee can be paid by credit/debit card (American Express, Discover, MasterCard, or Visa), personal or company check or money order (made payable to the New York City Fire Department). A convenience fee of 2 % will be applied to all credit/debit card payments.



For fee waivers submit (Only government employees who will use the Certificate of Fitness for work related responsibilities are eligible):

- A letter requesting a fee waiver on the Agency’s official letterhead stating applicant’s full name, exam type and address of premises, AND
- A copy of identification card issued by the Agency.

**EXAM INFORMATION:**

The **FLSD: Fire Component** exam will consist of **120** multiple-choice questions and the **FLSD: Non-Fire component** exam will consist of **55** multiple-choice questions. Both exams are administered on a “touch screen” computer based monitor. It is a timelimited exam. Based on the amount of the questions, you will have **186** minutes to complete the Fire Component exam and **83** minutes to complete the Non-Fire Component exam, passing score of at least 70% is required in order to obtain a passing letter.

**EXAM SITE:** FDNY Headquarters, 9 MetroTech Center, Brooklyn, NY. Enter through the Flatbush Avenue entrance (between Myrtle Avenue and Tech Place).





To: FDNY's Public Certification Users,

We are writing to inform you about some significant procedural changes that will come into effect as of **April 2, 2024**, regarding **all Certificates of Fitness**. These changes are a result of the need for more streamlined processes.

Starting from **April 2, 2024, ALL Certificate of Fitness applicants** will be **required to apply and pay online** ([fires.fdnyccloud.org](https://fires.fdnyccloud.org)) for their certification prior to coming to the FDNY. It is important to note that without proof of application and payment, individuals will not be permitted to enter the building for testing. All Certificate of Fitness (COF) transactions (exam, renew and update) must be done online and payment before coming to FDNY Headquarters.

Here are the key points:

**Online Application and Payment:** COF applicants must complete their application and payment process online. This can be done on <https://fires.fdnyccloud.org/CitizenAccess>

1. **Proof of Application and Payment:** Upon arrival for testing, applicants must provide proof of their application submission and payment confirmation. This could be in the form of an email (printed receipt or a digital copy on their mobile device).
2. **Step-by-Step Guide and Video tutorial to fill out the Online Application:** COF online application guide link; <https://www.nyc.gov/assets/fdny/downloads/pdf/business/fdny-business-cof-individuals-short.pdf> and Video tutorial link; <https://www.nyc.gov/site/fdny/business/all-certifications/certificates-of-fitness.page>
3. **No Exceptions:** Please be aware that there will be no exceptions to this new procedure. It is imperative that all applicants adhere to these guidelines. They will be turned away at the door if there is no proof of application.
4. **Assistance:** If anyone encounters difficulties or has questions regarding the online application and payment process, please do not hesitate to reach out to FDNY Business by calling 311. Our team will provide necessary assistance and support.

## **COMPUTER BASED EXAM PROCEDURES**

### **A. FLSD: Fire Component computer based exam**

#### ***(1) Scheduling the FLSD: Fire Component computer based exam:***

Applicants must take the FLSD: Fire Component Computer based examination within the **9 month valid period** of the FLSD School Graduation diploma. All applicants **MUST** have successfully completed the entire 31-hour FLS Director course or two separate courses including Fire component (20 hours), Non-Fire Component (EAP and Active Shooter and Medical Emergency Preparedness (11 hours) courses. The last date to take the Fire Component computer based exam will be determined based on the **LATEST** school diploma issued by an FDNY certified school.

**You must have an FDNY COF application ID before scheduling the appointment.**

To schedule an individual or a group appointment for FDNY computer based exam, log into the link below: <http://www1.nyc.gov/site/fdny/business/all-certifications/cof-online-scheduler.page>

Please cancel or reschedule your appointment at least 24 hours in advance if you cannot make it to the testing center to take the exam.

Appointments are between 1:10 pm -2:00 pm, five days a week (M-F) except for legal holidays. Starting processing time for a test is 2:00 P.M. No test will be administered to applicants who arrive after 3:00 P.M.

#### ***(2) Requirements for the FLSD: Fire Component computer based exam:***

1. Applicants must be at least 18 years of age.
2. Applicants must have a reasonable understanding of the English language.
3. Applicant must provide two forms of identifications; at least one form of identification must be government issued photo identification, such as a State-issued Driver's License or Non Driver's License or a passport.
4. Applicants must submit the **original** 31- hour Fire and Life Safety Director School graduation diploma for review to be processed for the exam. **The Graduation Diploma is valid for 9 months.**

Applicants are allowed to submit the original diplomas of 2 different courses to meet the 31-hour Fire and Life Safety Director training course requirement. The last date to take the computer exam will be determined based on the latest issuance date of one of these two FDNY certified school diplomas:

1. Original 20-hour school diploma (FLSD-General and Fire Component course)
2. Original 11-hour school diploma (FLSD- Non-Fire Emergencies)

(Note: The 11-hour school diploma can be separated into the 4-hour Active Shooter and Medical Emergency Preparedness school diploma or FLSD- NonFire Emergencies ASMEP diploma AND Original 7-hour FLSD: Non-Fire Emergencies EAP diploma)

#### **Exception:**

If the applicants have failed twice in the FLSD: Fire Component computer based exam, applicants may submit the expired 31-hour school diploma(s) AND an unexpired original copy of the 20-hour "FLS Director: General Topic and Fire Emergency" course diploma.

5. Applicants are prohibited from being employed by any FDNY- approved FLS Director, FSD, FS/EAP School for at least four (4) years after taking any FDNY FSD, EAP, or FLSD related exam.

6. Applicants must complete the following forms:

- Application for Fire and Life Safety Director (FLS Director) Certificate of Fitness.

The form can be downloaded from the following link:

<https://www1.nyc.gov/nycbusiness/description/certificate-of-fitness-for-fire-life-and-safety-director-f89t89>

- One Verification Letter (also attached in the following pages) from each employer listed in the application form above.

The letter can be downloaded from the following link:

<http://www1.nyc.gov/assets/fdny/downloads/pdf/business/cof-f85-verification-letter.pdf>

- A-20 (general C of F application form).

The form can be downloaded from the following link:

<http://www1.nyc.gov/assets/fdny/downloads/pdf/business/cof-application-form.pdf>

### ***Verification Letter (front)***

**FIRE DEPARTMENT CITY OF NEW YORK**

**BUREAU OF FIRE PREVENTION**

**9 METROTECH CENTER**

**BROOKLYN, N.Y. 11201-3857**

### **Verification Letter for Fire and Life Safety Director Application**

(For each employer listed in the FLSD application form, an individual affidavit must be submitted.)

### **INSTRUCTIONS**

In accordance with the procedures of the New York City Fire Department, applicants for the Fire and Life Safety Director exam must possess experience involving fire protection and fire prevention activities, or responsible positions pertaining to the operations of building service equipment.

The applicant has listed your firm for experience and dates. All information must be verified. Please complete the form below. The form below must be notarized. We thank you in advance for your cooperation.

**Firm or Company**

**Name** \_\_\_\_\_

**Business  
Address**

\_\_\_\_\_

Sir/Madam:

I am pleased to confirm the employment of \_\_\_\_\_ for application

Applicant's name

for a Certificate of Fitness as a Fire and Life Safety Director. The applicant was/is employed here in the title of

\_\_\_\_\_ during the following dates: from \_\_\_\_\_ to \_\_\_\_\_.

The

applicant's specific job responsibilities involve fire prevention activities or responsible position pertaining to

operation of building service equipment include(d) such as:

\_\_\_\_\_  
\_\_\_\_\_  
\_\_\_\_\_  
\_\_\_\_\_

\_\_\_\_\_  
Signature of employer                      Title  
(Sign only before a notary)

Date: \_\_\_\_\_

STATE OF \_\_\_\_\_

COUNTY OF \_\_\_\_\_

Sworn to before me, this  
\_\_\_\_\_ day of  
\_\_\_\_\_, 20\_\_\_\_

Notary Number: \_\_\_\_\_

Signature of notary

Commission Expires: \_\_\_\_\_

\*\*The completed form must be submitted promptly to the FDNY, 9 Metro Tech Center, Brooklyn, NY 11201, Attn: Certificate of Fitness Unit (FLSD Verification Section). Failure to submit this form will delay the processing of the candidate above. For additional information, please call (718) 999-2506 or (718)999-0649 during business hours or email [pubcert@fdny.nyc.gov](mailto:pubcert@fdny.nyc.gov)

## *Verification Letter (back)*

As per 3 RCNY §113-02, the FDNY began expanding the verification requirements for new Fire and Life Safety Director Candidates. We will be verifying all duties associated with (a) firefighting or other public safety emergency response employment; (b) any fire safety-related employment, including code enforcement, fire safety inspections, fire prevention or emergency preparedness; (c) the design, installation, operation or maintenance of building fire protection, electrical, plumbing, heating, ventilation, air conditioning , or other building systems regulated by the construction codes; or (d) equivalent related experience acceptable to the FDNY, three (3) years' full-time work experience in one or more of the fields , OR 18 months' full-time work experience in one or more of the fields that includes at least six (6) months of continuous employment at one work location is required in order to qualify.

### **(3) After the FLSD: Fire Component computer based exam:**

#### **1. Pass the FLSD: Fire Component computer based exam:**

The applicant will receive a computer based exam passing letter (N-85) stating that the applicant passed the computer based exam. The passing letter will allow the applicant to take the second computer based exam, FLSD: Non-Fire Component Exam. The passing letter is **NOT RENEWABLE** and **valid for 9 months from the issuance date**.

#### **2. Fail the FLSD: Fire Component computer based exam:**

The applicant will be given **two (2) opportunities to take and pass the computer based exam** on the basis of having successfully completed the required training course.

- The **first attempt** of the Fire Component computer based exam should be taken **within the 4 months valid period** from the date that the candidate completes the course requirements. The **second** computer based exam must be completed **within the 9 months valid period** from the date that the candidate completes the course requirements. **The candidate must schedule an appointment for the second attempt** (see appointment information above).
- If an applicant **fails** the computer based exam **the second time, the applicant must retake the 20hour “FLS Director: General Topic and Fire Emergency”** course in its entirety to be eligible to take the exam again. Email [pubcert@fdny.nyc.gov](mailto:pubcert@fdny.nyc.gov) for additional information concerning the computer based exam.

### **B. FLSD: Non-Fire Component computer based exam**

#### **(1) Scheduling the FLSD: Non-Fire Component computer based exam:**

Applicants must take the FLSD: Non-Fire Component Computer based examination (Z-89) within the **9month valid period** of

- the FLSD: Fire Component exam passing letter; OR
- the 11-hour “FLS Director: Non-Fire Emergencies EAP & ASMEP” courses, whichever is later.

To schedule an individual or group appointment for FDNY computer based exam, the applicants can log into the link below:

<http://www1.nyc.gov/site/fdny/business/all-certifications/cof-online-scheduler.page>

Please cancel or reschedule your appointment at least 24 hours in advance if you cannot make it to the testing center to take the exam.

Appointments are between 1:10 pm -2:00 pm, five days a week (M-F) except for legal holidays. Starting processing time for a test is **2:00 P.M.** No test will be administered to applicants who arrive after **3:00 P.M.**

**(2) Requirements for the FLSD: Non-Fire Component computer based exam:**

1. Applicant must provide two forms of identifications; at least one form of identification must be government issued photo identification, such as a State-issued Drivers' License or Non Driver's License or a passport.
2. Applicants must submit the **original copy and unexpired FLSD: Fire Component computer exam passing letter. The passing letter is valid for 9 months.**

**Exception:**

If the applicants have failed twice in the FLSD: Non-Fire Component computer based exam, applicants may submit the expired 31-hour school diploma(s) AND an unexpired original 11hour "FLS Director: Non-Fire Emergencies EAP & ASMEP" course diploma.

- Application for Fire and Life Safety Director (FLS Director) Certificate of Fitness.

The form can be downloaded from the following link:

<https://www1.nyc.gov/nycbusiness/description/certificate-of-fitness-for-fire-life-and-safety-director-f89t89>

- One Verification Letter (also attached in the following pages) from each employer listed in the application form above.

The letter can be downloaded from the following link:

<http://www1.nyc.gov/assets/fdny/downloads/pdf/business/cof-f85-verification-letter.pdf>

3. Applicants are prohibited from being employed by any FDNY- approved FLS Director, FSD, FS/EAP School for at least four (4) years after taking any FDNY FSD, – EAP, or FLSD related exam.

**(3) After the FLSD: Non-Fire Component computer based exam:**

**1. Pass the FLSD: Non-Fire Component computer based exam:**

Applicants will receive a computer based exam passing letter (Z-89) stating that the applicant passed the FLSD: Non-Fire component computer based exam.

The qualification will be reviewed after the Z89 letter is issued. The applicant will be notified within 4 to 6 weeks regarding this qualification review.

If the qualifications are deemed acceptable, **the Certificate of Completion (COC) will be sent in email**, which will allow you to schedule your On-Site Exam.

If the qualifications are not accepted, the applicant will receive a Notification in email requesting for additional information. The applicant must submit the additional documents requested in that email before the deadline or you will be disqualified and need to start over:



- retake TWO FDNY computer exams (within 1 year from the date on the disqualification notification) or
- retaking 31-hour FLSD course if the disqualification notification has been sent for more than one year.

The Certificate of Completion will allow the applicant to schedule the On-Site Examination (See the “OnSite Examination Procedures” listed on the following pages). The Certificate of Completion is NOT RENEWABLE. It is valid for one (1) year. If the qualifications are not accepted, the applicant will receive a Disqualification Letter.

2. Fail the FLSD: Non-Fire Component computer based exam:

The applicant will be given **two (2) opportunities to take and pass the non-fire component computer based exam** on the basis of having successfully passed the fire component exam.

- The **first attempt** of the Non-Fire Component computer based exam should be taken **within the 4 months valid period** from the date that the candidate completes the course requirements. The **second** computer based exam must be completed **within the 9 months valid period** from the date that the candidate completes the course requirements. **The candidate must schedule an appointment for the second attempt** (see appointment information above).
- If an applicant **fails** the computer based exam **the second time, the applicant must retake the 11hour “FLS Director: Non-Fire Emergencies EAP and ASMEP”** course in its entirety to be eligible to take the Non-Fire component exam again. Email [pubcert@fdny.nyc.gov](mailto:pubcert@fdny.nyc.gov) for additional information concerning the computer based exam.

(3) On-Site exam (F-89/T-89)

A. **Fees** F-89 FLS Director On-Site Exam fee: \$750.

The F-89 FLS Director On-Site Exam include three major components: General Building Knowledge, Fire Component, and Non-Fire Component. Refer to Part V of this booklet for the detail content.

If the candidate fails the first On-Site Exam, the second F-89 On-Site Exam will be charged based on the components the candidate needs to retake.

Retested Component(s)	Retest fee
Non-Fire Component only	305
Fire Component only	445
General Building Knowledge only	445
General Building Knowledge & Fire Component	445
General Building Knowledge & Non-Fire Component	305
Fire Component & Non-Fire Component	750
General Building Knowledge, Fire Component & Non-Fire Component	750

- T-89 temporary FLS Director On-Site exam fee: \$445

If the candidate fails the entire On-Site Exam (total score is less than 70, fails 2 or more important questions, or fails at least one mandatory question ) but passes one components of the exam, the



candidate may choose only to retake the failed component (General Building Knowledge or Fire Component) he/she fails. However, the fee will still be charged in full (T-89 On-Site exam: \$445).

- Overtime fee:

If an overtime exam Monday to Friday after **4:00 PM** or on Saturday is requested, additional overtime expenses will be charged. The invoice for the total fee will be sent to the building where the On-Site Exam was administered.

- T-89/F-89 FLS Director issuance fee: \$25.

To obtain a new T-89/F-89 Certification Card, any candidate who passes the T-89/F-89 must follow the instruction in the exam result notification email to pay the \$25 card issuance fee online.

### **B. To schedule the On-Site Exam**

Only authorized personnel (designated by the building owner) are allowed to schedule an On-Site F-89 or T-89 Exam. Candidates cannot schedule their own exams.

The **first attempt** of the On-Site exam should be scheduled **within 6 months** from the date that the candidate received the Certificate of Completion. In addition, any other On-Site exam request must be submitted within **one (1) year** from the date that the candidate received the Certificate of Completion. **The Certificate of Completion is NOT RENEWABLE.**

**The onsite exam application MUST be submitted online. No email and no phone appointment call will be accepted.**

Instructions on how to request an FLSD onsite can be found here:

<http://www1.nyc.gov/assets/fdny/downloads/pdf/business/flsd-user-guide.pdf>

Create an Account and Log in to:

<http://fires.fdnyccloud.org/CitizenAccess/SAML/NYCIDLogin.aspx>

In the case of hardship, the authorized personnel can request an emergency overtime test Monday to Thursday after 4 PM, or on Saturday. Additional overtime expenses will apply.

Only **two** candidates can be scheduled per day during **normal business hours** and on **Saturdays**. Only **one** candidate can be scheduled per day during **evening hours**.

### **C. Specific information for the F-89 On-Site Exam (the premises with a Comprehensive Fire Safety and Emergency Action Plan)**

To qualify candidates for the **F-89** On-Site Exam, the authorized personnel must ensure:

- **The candidates received the FDNY FLS Director Certificate of Completion.**
- **The building has a Comprehensive Fire Safety and Emergency Action Plan accepted by the FDNY.**

**If candidate's premises' Comprehensive Fire Safety and Emergency Action Plan has NOT been accepted by the FDNY, the candidate must apply for the T-89 On-Site exam before the Certificate of Completion expires.**

The average testing time of the F-89 On-Site Exam is approximately 4-5 hours. The testing environment should be expected to be occupied for at least 5 hours.

Before the On-Site Exam, the supervisor must ensure:

- (1) The candidate is physical capable to take the on-site exam and to perform the duties and responsibilities required of the FLS Director if he/she is certified.
- (2) The most recent plan is available to the FDNY, including Building Information Card (BIC) and Comprehensive Fire Safety and Emergency Action Plan or Fire Safety and Evacuation Plan.
- (3) The fire alarm panel and the elevator(s) (if applicable) are fully functional.
- (4) A suitable environment is available for the FDNY inspector to administer the On-Site Exam (see “OnSite Exam environment” section).

Failure to fulfill the requirements listed above before the On-Site Exam may result in termination of the test.

The On-Site Exam fee will be charged.

**D. Specific information for the T-89 On-Site Exam (the premises with a Fire Safety and Evacuation Plan only)**

To qualify the candidate for the **T-89** On-Site Exam, the authorized personnel must ensure:

- **The candidates received the FDNY FLS Director Certificate of Completion. (or The candidates received the FDNY FLSD Certificate of Completion AND has passed the FDNY Non-Fire Component computer based exam);**
- **The building has a Fire Safety and Evacuation Plan submitted to the FDNY;**
- **Applicants must prepare a “T-89 Designation Letter” from the employer or building owner recommending the applicants for the computer based exam. A sample letter is attached in the following page. The sample letter will also be available on FDNY website.**

The average testing time of the T-89 On-Site Exam is approximately 3.5 hours. The testing environment should be expected to be occupied for at least 4 hours.

Before the On-Site Exam, the most recent plan must be available to the FDNY, including Building Information Card (BIC) and Fire Safety and Evacuation Plan. Failure to produce the required documents before the On-Site Examination can result in termination of the test. The On-Site Exam fee will be charged.

The T-89 applicants **must also submit the T-89 Designation Letter** signed by the employer/supervisor to the inspector **upon the On-Site Exam. The COF unit will NOT issue the T-89 Certificate of Fitness until the Designation Letter has been submitted.**

**SAMPLE DESIGNATION LETTER (for T-89)**

**MUST BE SUBMITTED ON COMPANY LETTERHEAD**

To: FDNY  
Bureau of Fire Prevention  
9 MetroTech Center,  
Brooklyn, NY 11201

From: \_\_\_\_\_  
\_\_\_\_\_  
\_\_\_\_\_

Date: \_\_\_\_\_

Subject: Request to apply T-89 Certificate of Fitness

Re: \_\_\_\_\_  
(Applicant's name)

The above individual will be designated as a Fire and Life Safety Director at

\_\_\_\_\_  
\_\_\_\_\_  
\_\_\_\_\_ (PREMISES ADDRESS)

Company name: \_\_\_\_\_

The Comprehensive Fire Safety and Emergency Action (Level 1) Plan of the premises listed above has not been submitted to FDNY.

The candidate listed above has been designated to be an FLS Director or Deputy FLS Director for the premises at the above address. The applicant is of good character and is physically able to perform the duties and responsibilities required from the holder of this Certificate of Fitness. Before our premises obtain the FDNY acceptance of its Comprehensive Fire Safety and Emergency Action (level 1) plan, we recommend this candidate to perform the duties of an FLS Director on an interim basis with the valid T-89 Certificate of Fitness. This candidate will be authorized to implement the provisions of FC Chapter 4 and R404-01 with respect to fire emergencies and to take such actions in response to non-fire emergencies as the building owner authorizes, based on the standard FDNY non-fire emergency procedures and the plan or procedures currently in place for our premises. **We understand that once our premises obtains the FDNY acceptance of the Comprehensive Fire Safety and Emergency Action (Level 1) plan, we will immediately schedule the applicant for the Non-Fire portion On-Site Exam to obtain the F-89 Certificate of Fitness.**

Sincerely,

\_\_\_\_\_  
Building Owner or Manager (Contact phone number: \_\_\_\_\_ - \_\_\_\_\_ - \_\_\_\_\_)

#### **E. Special requirements for additional work location:**

Applicants are allowed to hold F-89/T-89 for two separate locations at the same time without special restrictions. Applicants employed as an F-89/T-89 holder at three or more locations must apply for a modification/variance. A \$200 non-refundable fee is required with each application that can be found on the following link:

<http://www1.nyc.gov/assets/fdny/downloads/pdf/business/variance-fsd-eeap-form.pdf>

Under the modification/variance program, the applicants are subject to the On-Site Exam in order to renew the Certificate for each location.

Candidates who work in multiple buildings and are subjected to R-59/R-58 after failing the first attempt at an

On-Site Exam due to important responses, will not be allowed to schedule the second attempt at an On-Site Exam unless they pass the R-59/R-58 computer based exam.

#### **F. To cancel or reschedule the On-Site Exam**

All requests for cancellations must be submitted via FDNY Business.

Create an Account/Login to FDNY Business

<http://fires.fdnyccloud.org/CitizenAccess/SAML/NYCIDLogin.aspx>

Cancellations cannot be requested until confirmation of scheduled appointment has been received.

All cancellations must be received at least 72 hours before the scheduled time via email.

The building will be charged the On-Site Exam fee **if the cancellation request is received less than 72 hours prior to the On-Site Exam. Any candidate canceling three (3) On-Site Exams will not be allowed to schedule an On-Site Exam until after 6 months following the third cancellation.**

If the authorized personnel (designated by the building owner) needs to reschedule the candidate, the cancellation must be submitted first. After the cancellation is confirmed by the High Rise Unit, the authorized personnel can schedule the On-Site Exam for another date by submitting another request.

#### **G. On-Site Exam environment**

In order to maximize all candidates' testing performance, the candidates or the supervisor must arrange a suitable environment for the FDNY inspector to administer the On-Site Exam.

A suitable testing environment includes but is not limited to:

- adequate room lighting • adequate ventilation
- comfortable seating and clean work surfaces for the candidates to take notes and answer questions.
- minimum noise and no distractions during the exam
- Alarms and announcements will be sounded at various points during this exam, refer to "(4) What to expect during the On-Site Exam".

The average testing time of the On-Site Exam is approximately 4 hours. The testing environment should be expected to be occupied for at least 5 hours.

FDNY inspectors have the right to move the candidate to a proper testing environment.

#### **H. On-Site Exam Grading**

Different weightings are assigned for different questions. For example, there are **mandatory and important questions** in the On-Site exam. **Candidates must receive a score of at least 70% and pass**

**all mandatory questions and not fail more than one important question. If candidates do not successfully perform any mandatory response or fail two important questions, candidates will NOT receive a passing score.**

The mandatory questions are building specific, where a practical demonstration is required. The important questions are generic questions, tasks or the actions that must be explained as part of the answer to a question or scenario.

**The inspectors only record candidates' VERBAL answers but do not grade the exams.** The On-Site Exam will be graded by a third party unit at the FDNY. If you feel the examiner(s) did not provide a fair environment or opportunity, you may file a complaint by email. We assure that all complaints will be kept confidential.

Complaints and/or concerns regarding the administration of the On-Site Exam:

- must be received by email **within 24 hours of your On-Site Exam**
- address your complaints to [pubcert@fdny.nyc.gov](mailto:pubcert@fdny.nyc.gov)
- subject line must read **FS/EAP Director On-site Complaint**
- In the body of the email please include
  1. Your full name
  2. Your last **4 digits** of Social Security number
  3. The date the On-Site Exam occurred
  4. Describe the specific issue in detail

**The grading process may take from six (6) to eight (8) weeks. The exam results (pass or fail) will be sent to email address provided by the candidate as well as their employer.**

**When candidate passes onsite, \$25 Certificate of Fitness (COF) fee is due within 30 days of result letter date. It is candidate's responsibility to CHECK THE EMAIL FOR THE EXAM RESULT and to follow the instruction accordingly in order to receive the FLSD Certificate of Fitness card.**

Application for COF and Fee must be completed online:

<http://fires.fdnyccloud.org/CitizenAccess/SAML/NYCIDLogin.aspx>

### **I. The Consequence of Failing the On-Site Exam**

- *First failure:*

If the candidate fails the On-Site Exam, the exam fee will not be refunded. Applicants will be permitted to take two (2) On-Site Exams; however, applications for a second On-Site Exam must be requested before the expiration date listed on the FLSD Certificate of Completion.

If the candidate fails the entire On-Site Exam (total score is less than 70, fails 2 or more important questions, or fails at least one mandatory question ) but passes one or two parts of the exam, the candidate may choose to only retake the part(s) he/she fails. The fee will be based on the parts that the candidate needs to retake (refer to the Section 0.2.1. (3) A. fee of this Notice of Exam).

- *Second failure:*

If the candidate does not pass the On-Site Exam after the second attempt and the candidate does not have any valid F-89/T-89/Q-89C of F, the candidate will be required retake and pass two FDNY computer based exams

(Fire and Non-Fire Components) and obtain a new Certificate of Completion. The candidate must **pass the**

**FLSD: Fire Component computer exam within 1 year from the issuance date of the second failure notice.** If the candidate fails to pass the computer based exam within 1 year, the candidate has to restart the entire process by retaking the 31-hour FLSD course.

- *Candidates who hold valid T-89/F-89 C of F for other premises and miss two or more important questions during an On-Site Exam in additional building,*

If the candidate is seeking to be certified in an additional building and fails the On-Site Exam because he/she missed two or more important responses for the Fire Component of the On-Site Exam, the candidate will be required to take and pass a written Remedial FLS Director: Fire Component Examination (R-58) before being permitted to schedule another On-Site Exam.

If the candidate is seeking to be certified in an additional building and fails the On-Site Exam because he/she missed two or more important responses for the Non-Fire Component of the On-Site Exam, the candidate will be required to take and pass a written Remedial FLS Director: Non-Fire Component Examination (R-59) before being permitted to schedule another On-Site Exam.

Failure to pass the R-58/R-59 exam or ignoring the R-58/R-59 notice will result in a suspension of the Fire and Life Safety Director (F-89/T-89) certifications. See the Notice of Examination R-59/R-58 for further information.

### **0.2.2 Other fees**

- Renewal fee

Renewal fee for the F-89 C of F is \$15.00. It applies for any Certificate of Fitness to be renewed from 90 days before to 90 days after the expiration date. It is very important to renew your C of F before it expires. Renewals submitted 90 days (up to one year) after the expiration date will incur a \$25 penalty in addition to the renewal fee. Certificates expired over one year past expiration date will not be renewed. New exams will be required.

- Update, replacement and duplicate fee

To change a mailing address or obtain a duplicate Certificate of Fitness, you should submit a letter requesting the change of mailing address or a duplicate C of F with \$5.00 fee.

- C of F for additional building(s)

If a current T-89/F-89 Certificate of Fitness holder wants to be certified in another building, in addition to the required On-Site Exam fees and possible variance fee (refer to the Section 0.2.1. (3)(E) of this Notice of Exam), the candidate will be charged \$25 to obtain the new Certificate of Fitness (T89/F-89) card after he/she passes the On-Site Exam for the new building.

### **0.2.3 Valid period and expiration issues**

- (1) The FLSD related school graduation diploma(s) (including the 31-hour, 20-hour, 11-hour courses)

- All FLSD School Graduation diplomas issued on or after 02/01/2018 are valid for 9 months. They are **NOT RENEWABLE**. The expiration date will be counted based on the latest school diploma issuance date. If the latest school diploma is expired, the applicant must re-attend the required 31hour course in its entirety.

- (2) Active Shooter and Medical Emergency Response School graduation diploma/letter

- This diploma does not have an expiration date. It may be combined with the FS/EAP courses to be qualified for taking the FLSD computer based exams. **It will become invalid if the candidate fails the FDNY Non-Fire Component CBT twice.**

(3) FDNY computer based exam passing letter

- The FDNY FLSD: Fire Component computer based exam passing letter (N-85 letter) is valid for **9**

**MONTHS. It is NOT RENEWABLE. Within 9 months, candidates must pass the FLSD: NonFire Component computer based exam.**

- If it is expired less than one year (within 1 year and 9 months from the issuance date), the applicant must retake and pass the FLSD: Fire Component computer based exam to obtain a new N-85 letter.
- If it is expired more than one year (more than 1 year and 9 months from the issuance date), the applicant must retake the 20-hour “FLSD: General Topic and Fire Emergency” course and pass the FLSD: Fire Component computer based exam to obtain a new N-85 letter.
- The FDNY FLSD: Non-Fire Component computer based exam passing letter (Z-89 letter) is valid for **12 MONTHS. It is NOT RENEWABLE.**

(4) The FDNY Certificate of Completion:

The FDNY Certificate of Completion is valid for **one year. It is NOT RENEWABLE.**

- If it has expired, the candidate must retake and pass the two computer based exams to receive a new Certificate of Completion to schedule the On-Site.
- If it has expired more than one year (more than 2 year from the issuance date), the candidate must retake the 31-hour FLSD course, pass TWO computer based exams to receive a new Certificate of Completion.

(5) F-89 C of F

- The FDNY F-89 Certificate of Fitness is valid for three years. It is renewable. *If the F-89 Certificate has been expired more than 90 days:*

- 90 days to 1 year

An additional \$25.00 late fee applies when the renewal is requested after 90 days but before one (1) year after the expiration date.

- more than 1 year

No Certificate will be renewed if expired for one year after the expiration date. **If the F-89 certificate has expired over one year, the applicant must retake the 31-hour FLSD course, pass TWO computer based exams, and pass the FLSD On-Site Exam.**

(6) T-89 C of F

- Once the T-89 C of F holder’s premises obtains the FDNY acceptance of the Comprehensive Fire Safety and Emergency Action (Level 1) Plan, the authorized personnel (designated by the building owner) must IMMEDIATELY schedule the T-89 C of F holder for the non-fire portion (EAP) of the On-Site Exam to obtain the F-89 Certificate of Fitness.

- The FDNY T-89 Certificate of Fitness may be valid up to three years. **This Certificate of Fitness is ONLY valid in the premises that has not yet obtained FDNY acceptance of the Comprehensive Fire Safety and Emergency Action Plan.**

(7) F-59/F-25/F-58/F-85 C of F

- Based on the Fire Rule 113-02 (f), effective 03/01/2020, the F-59/F-25/F-58/F-85 C of F will no longer be a valid C of F. All F-59/F-25/F-58/F-85 C of Fs must be transferred to T-89/F-89 by fulfilling the new requirements. Only F-89/T-89 Certificate of Fitness will be recognized as the valid FLS Director Certificate of Fitness. Holding any valid or expired F-59/F-25/F-58/F-85 C of Fs cannot request any wavier of 31-hour FLSD course or N-85/Z-89 exam.

#### **0.2.4 Inactive Certificate of Fitness**

Individuals who no longer work at the premises where they were previously certified as a Fire and Life Safety Director should return their Certificate of Fitness card(s) and submit the completed Surrender Certificate of Fitness Form back to the Fire Department.

The Surrender Certificate of Fitness Form can be found on the following link:

<http://www1.nyc.gov/assets/fdny/downloads/pdf/business/surrender-cof-applicant-form.pdf>

The Certificate of Fitness number and expiration date will be carried to the Q-89 Inactive Fire and Life Safety Director Certificate of Fitness after candidates successfully surrender the F-89 Certificate of Fitness Card. The renewal procedures of Q-89 Certificate of Fitness will be same as F-89 Certificate of Fitness.

#### **0.2.5 Renewal procedure**

- 1) **F-85 Based on the Fire Rule 113-02 (f), effective 03/01/2020, F-85 is no longer valid and no longer renewable.**
- 2) **T-89** Certificate of Fitness may or may NOT be renewed. The requirements will be outlined upon the completion of the Level 1 plan Rule.
- 3) **F-89** Certificate of Fitness must be renewed every **THREE YEARS**. FDNY also reserves the right to require the applicants to take a re-examination upon submission of renewal applications. responsibility to renew your Certificate. It is very important to renew your C of F before it expires.

The F-89 C of F card can be renewed **On-line, by Mail or in Person**.

- Renewal online

***Fee exempted applicants cannot renew online only by mail or in person. (Only government employees who will use their C of F for work- related responsibilities are eligible for fee waivers.)***

If you are an individual, make sure you have your 12 digit Certificate of Fitness Access ID. This can be found on your Renewal Notice. If you do not have your Renewal Notice, your Access ID is your 8 digit Certificate of Fitness number and the last four (4) digits of your social security number. If you are submitting renewals on behalf of a company's employees, the company must be approved by FDNY and have an 8 digit Company Code.

To request approval company renewal code, email [pubrenew@fdny.nyc.gov](mailto:pubrenew@fdny.nyc.gov).

Renewal fee can be paid by one of the following methods:

- Credit card or Debit card (American Express, Discover, MasterCard, or Visa)
- E-check



A convenience fee of 2 % will be applied to all credit/debit card payments for original or renewal certificates.

If all the requirements are met, the C of F will be mailed to the mailing address within 10 days.

For online renewal go to: <https://a836-citypay.nyc.gov/citypay/FDNYCOF>

- *Renewal by mail*

Mail your Renewal Notice (if you did not receive a Renewal Notice, a copy of your certificate), along with your fee payment:

Personal or company check or money order (made payable to the NYC Fire Department)

For fee waivers submit: ***(Only government employees who will use their C of F for work-related responsibilities are eligible for fee waivers.)***

- A letter requesting fee waiver on the Agency's official letterhead stating the applicant's full name, exam type, and address of premises; **AND**
- Copy of identification card issued by the agency (if applicable)

All supporting documents should be mailed to:

**NYC Fire Department (FDNY)**

Cashier's Unit

9 MetroTech Center, 1st Floor

Brooklyn, NY 11201

If all the requirements are met, the Certificate of Fitness will be mailed out within (4) to (6) weeks.

- *Renewal in person*

Submit your Renewal Notice (or if you did not receive a Renewal Notice, a copy of your certificate), along with your fee payment by one of the following methods:

- Credit card or Debit card (*American Express, Discover, MasterCard, or Visa*)
- Personal or company check or money order (*made payable to the New York City Fire Department*)

A convenience fee of 2 % will be applied to all credit/debit card payments for original or renewal.

For fee waivers submit: ***(Only government employees who will use their C of F for their work-related responsibilities are eligible for fee waivers.)***

- A letter requesting fee waiver on the Agency's official letterhead stating the applicant's full name, exam type, and address of premises; **AND**
- Copy of identification card issued by the agency and if applicable, your supporting documents:

### ***0.2.6 Special renewal procedures for F-89 C of F holder with 3 or more locations***

Applicants who are enrolled in the multiple-location-variance program (as F-89/T-89 at three (3) or more locations) must retake and pass the On-Site Exam in order to renew the Certifications for each location.

The F-89/T-89 COF will be temporary blocked if it is expiring within the next 6 months. It will not be renewed until the COF holder pass the onsite exam at that premises.

If the COF holder fails twice for the onsite exam or does not pass the onsite exam before it is still renewable (one year after the expiration date), the COF will be permanently voided.

## **Chapter 1. COMPREHENSIVE FIRE SAFETY AND EMERGENCY ACTION PLAN AND OWNER OBLIGATIONS**

As established in the 2008 New York City Fire Code, a Fire Safety and Evacuation plan is required for the following occupancies and buildings:

1. Group A occupancies, other than Group A occupancies used exclusively for purposes of religious worship that have an occupant load less than 2,000.
2. Group B occupancy office buildings or parts thereof and other office buildings or parts thereof, occupied or designed to be occupied by more than 500 persons on one or more floors, including street level, or by more than 100 persons on one or more floors other than street level.
3. Group B occupancy educational facilities.
4. Group E occupancy schools, educational facilities, and day care facilities.
5. Group H occupancies, except buildings or parts thereof that have prepared one or more of the following plans in compliance with applicable requirements:
  - 5.1. An emergency action plan in accordance with the regulations of the United States Department of Labor, as set forth in 29 CFR Section 1910.119.
  - 5.2. A contingency plan and emergency procedures in accordance with the regulations of the New York State Department of Environmental Conservation, as set forth in 6 NYCRR Part 373.
  - 5.3. A risk management plan in accordance with the rules of the New York City Department of Environmental Protection, as set forth in 15 RCNY §41-08.
6. Group I occupancies.
7. Group M occupancies occupied or designed to be occupied by more than 500 persons on one or more floors, including street level, or by more than 100 persons on one or more floors other than street level, or in which more than 25 persons are employed.
8. Group R-1 occupancies, occupied by more than 30 lodgers, or more than 15 lodgers above street level, for a period of 90 days or less; and/or operated to accommodate such numbers of lodgers for such period of occupancy; and/or designed to contain a total of more than 30 sleeping rooms, or more than 15 sleeping rooms above the street level, for such period of occupancy; and/or occupied by one or more lodgers on a floor more than 75 feet above the street level, for such period of occupancy, or operated or designed for such lodging.
9. Group R-2 occupancies occupied by more than 30 lodgers, or more than 15 lodgers above street level, for a period of 90 days or less; and/or operated to accommodate such number of lodgers for such period of occupancy; and/or designed to contain a total of more than 30 sleeping rooms, or more than 15 sleeping rooms above the street level, for such period of occupancy; and/or occupied by one or more lodgers on a floor more than 75 feet (22 860 mm) above the street level, for such period of occupancy, or operated or designed for such lodging.
10. Buildings or parts thereof equipped with a fire alarm system with voice communication of the type required in Class B, R-1 or M occupancies, regardless of whether such system is required in such building or part thereof.

11. Buildings with an atrium and containing a Group A, E or M occupancy.
12. Covered malls exceeding 50,000 square feet in aggregate floor area.
13. Buildings that are greater than 6 stories or 75 feet in height, except Group R-2 occupancies.
14. Underground buildings occupied or designed to be occupied by more than 100 persons below street level.
15. Buildings occupied or designed to be occupied to provide emergency shelter for more than 15 homeless persons for more than 30 days in a year.

Since 2011, owners of high-rise office buildings, including those in mixed-use occupancies, have been required to file a Comprehensive (Combined) Fire Safety and Emergency Action Plan, which combined the fire safety plan and emergency action plan. The new Comprehensive Plan has been required for all new or amended plans for office occupancies.

The 2014 Code requires a new Rule to be established for the updated Comprehensive Fire Safety and Emergency Action (Level 1) Plan. The new Rule will specify the format, content, and supporting

documentation of the plan. The FLS Director must be familiar with their current plan and aware of any changes requiring an amendment to the plan. The FLS Director is the person authorized to implement the plan. A significant portion of the On-Site Exam will be based on the FDNY plan for the premises.

**A copy of the FDNY plan, Building Information Card, and floor plans must be kept at the Fire Command Center.**

## 1.1 Owner obligations

Owners of the premises required by the Fire Department to have an FDNY plan (Fire Safety and Evacuation Plan or Comprehensive Fire Safety and Emergency Action Plan) have the following obligations:

- (A) Preparation of Fire Safety and Evacuation Plan or Comprehensive Fire Safety and Emergency Action Plan.

An owner must cause the required plan to be prepared for each occupancy or building, submitted for department review and acceptance (when required by the Fire Code and Rules), and periodically reviewed and amended, in compliance with the requirements of the Fire Code and Fire Rule. The plan must follow the FDNY instruction.

- (1) Floor plans.

Each plan must include floor plans for the building or occupancy. The floor plans must be submitted to the department and maintained at the premises.

- (2) Building Information Card (BIC).

A Building Information Card must be maintained at the Fire Command Center, to serve as a ready reference for firefighting and other emergency response personnel. The building information card must be 11" x 17" in size, double-sided and laminated, and contain a color-coded plot plan and elevation of the building, and detailed building information.

(3) Floor postings.

When required by the Fire Rule, signs identifying FLS staff must be conspicuously posted on each floor, and maintained at an approved location on the premises, where they must be made available for inspection by Fire Department representatives.

(4) Building profile.

When required by the Fire Rule, a building profile must be prepared and submitted to the Department to serve as a ready reference for Department oversight of emergency preparedness and for use in connection with Department fire safety inspections.

(B) Designation of FLS staff.

An owner of any premises having a Comprehensive Fire Safety and Emergency Action Plan must designate competent persons to act as FLS staff, including a person designated to serve as FLS Director. The owner must employ or otherwise retain sufficient FLS staff to implement such plan during regular business hours and to otherwise comply with the requirements of the Fire Code and the Fire Rules. The persons designated as FLS staff must possess such qualifications and/or hold such Certificates of Fitness as are required by the Fire Code or Fire Rules. The owner must designate an FLS Director, deputy FLS Directors, FLS building evacuation supervisors, FLS wardens, deputy FLS wardens, FLS brigade members, FLS searchers, and critical operations staff in the plan.

An owner of any premises with Fire Safety and Evacuation Plan (FSP) must designate in the plan FLS staff responsible for the implementation of such plan, with the authority, duties, and responsibilities set forth therein.

The owner must designate FLS Director, deputy FLS Director, and FLS brigade members in the plan.

(C) Cooperation of building occupants.

When the owner becomes aware that a building occupant is neglecting or failing to cooperate with his or her duties, responsibilities or obligations to comply with the FDNY plan, the owner must notify the employer of such individual. If the employer fails to timely correct the condition the owner must notify the Fire Department.

(D) Plan submission, acceptance and/or maintenance on premises.

An owner must ensure a Fire Safety and Evacuation Plan or Comprehensive Fire Safety and Emergency Action Plan is submitted to, and acceptance obtained from, the Fire Department. A paper copy of the FDNY plan for the premises, including floor plans, must be maintained on the premises, at an approved location (i.e. the Fire Command Center), and must be made available for inspection by any Fire Department representative.

(E) Drills.

An owner must ensure required drills are conducted in accordance with Fire Code. The drills must be in the form of live instruction except as otherwise authorized by the Fire Code or Fire Rules.

(F) FLS staff training.

An owner must ensure FLS staff is trained. FLS staff training must be in the form of live instruction except as otherwise authorized by the Fire Code or Fire Rules.

(G) Recordkeeping.

An owner must ensure records are maintained.

(H) Fire emergency reporting signage.

Signage must be provided in the lobby or entrance hall of each building.

(I) Neighboring buildings.

An owner of any premises requiring a Comprehensive Fire Safety and Emergency Action Plan must consult with the owners of neighboring buildings in connection with the preparation of the building's plan.

## **1.2 Obligations of building occupants and their employers**

All building occupants and employers of building occupants must comply with the directions of the FLS staff upon implementation of the FDNY plan.

## **1.3 Authority to implement the FDNY plan**

The FDNY plan must be immediately implemented and building occupants must be directed to shelter in place, relocate within the building, partially evacuate, or fully evacuate, whenever such action is deemed necessary to ensure the safety of building occupants.

The ability of the FLS Director or other FLS staff designated to implement the FDNY plan must not be subordinated to the authority of any other person or impaired by any notification procedure established by the owner. The FLS Director or other FLS staff designated to perform such duty, must determine the safest and most efficient course of action consistent with the FDNY plan, depending on the nature of the fire or non-fire emergency.

In the absence of the FLS Director, the authority of implementing the plan must be assumed by a deputy FLS Director. If FLS Director or deputy FLS Director is not required to be on duty, the authority must be assumed by an FLS Building Evacuation Supervisor.

## **1.4 Compliance with orders of lawful authorities**

The owner, FLS Director, and all other FLS staff and building occupants must comply with the orders of the Fire Department or other incident commander or emergency response personnel.

## **1.5 Official notifications of fires and implementation of FDNY plan.**

**Any fire must be immediately reported to 911.**

The FLS Director, or other FLS staff designated to perform such duty, must immediately report to 911 a determination to implement the FDNY plan.

In a building of combustible construction, the FLS Director or other FLS staff must immediately notify predetermined representatives of other occupancies in the building.

## 1.6 Communications with building occupants

The FLS Director or other designated FLS staff must communicate the information and directions to building occupants whenever the FDNY plan is implemented, including during any drill. It must be communicated by the sounding of an alarm or alert tone followed by an announcement.

The content of the announcement must cover the required information based on the emergency situation. It will vary in fire related emergencies, non-fire emergencies or active shooter emergency (refer to Chapter 11, Chapter 15, and Chapter 18 of this curriculum).

The announcement must be repeated or updated on a frequent basis, to inform and reassure building occupants.

## 1.7 Content of Current Comprehensive Fire Safety and Emergency Action Plan and Fire

### Safety and Evacuation Plans

Group R-1 occupancy (Hotels) buildings are required to submit the Fire Safety and Evacuation Plans to the Fire Department for acceptance.

The Comprehensive Fire Safety and Emergency Action Plans are commonly found in office buildings and are required to be submitted to the Fire Department for acceptance.

Questions regarding the format and submission of the plan should be directed to the Emergency Planning and

Preparedness Unit of the Bureau of Fire Prevention at Fire Department Headquarters. (Email PlanHelp@fdny.nyc.gov or call 718-999-1512)

The plans include but are not limited to the following topics: (The shaded parts are the information that must be included in the Comprehensive Fire Safety and Emergency Action Plan but not required in the Fire Safety and Evacuation Plan)

- Owner's Certification
- Building Information
  - Complete building address
  - Building owner information
  - Height of building and number of stories above and below grade.
  - Lawful use and occupancy
  - Indicate individual floor occupancy loading
  - Fire Command Center (location, building communication)

*Specify the floor on which the Fire Command Center is located, its location on such floor, and the building entrance most accessible to the Fire Command Center. Indicate the areas of the building with which the Fire Command Center has communications capabilities, including elevator cars, fire pump rooms, mechanical equipment rooms, elevator control rooms, and individual floors. Only include communications equipment installed in accordance with the Building Code, and indicate if such communication is one-way or two-way.*

- Signage (Floor number signs, elevator bank designation signs, floor diagram signs, and stairway identification signs)
- Times of day and days of week when building is occupied (regular business hours and other times that the building will be occupied)
- FS/EAP (FLS) Staff Designations, Duties and Responsibilities and how to be identified during drills and emergencies
  - Fire Safety/EAP (FLS) Director
  - Deputy Fire Safety/EAP (FLS) Director
    - (FLS) Director at all times that a Fire Safety/EAP (FLS) Director is required to be on duty, but is absent;*
  - Fire Safety and EAP (FLS) Building Evacuation Supervisor
  - Fire Safety and EAP (FLS) Warden
  - Deputy Fire Safety and EAP (FLS) -Warden
  - Fire Safety and EAP (FLS) Searchers
  - Fire Safety and EAP (FLS) Brigade
  - Critical Operations Staff (Building Personnel and Office Employees)
- Fire Safety and Evacuation Instructions
  - General Statement. The following factors must be expeditiously determined and considered in implementing the FDNY plan in the event of a fire in the building.
  - Implementation of Fire Safety and Evacuation Plan
  - Use of Elevators
  - Procedures for accounting for building occupants after completing in-building relocation or partial evacuation
  - Procedures for identifying building occupants who require assistance and the procedures for providing such assistance
- Emergency Action Plan for Explosions
- EAP for Biological incident/release
- EAP for Chemical incident/release
- EAP for Nuclear incident/release
- EAP for Natural disaster
- EAP for Other emergencies
- Consultation with Neighboring Buildings
- Building Maintenance Program
  - Sprinkler and standpipe systems
  - Fire alarm systems
  - Emergency power systems

- Phase I and Phase II elevator operations
  - Smoke control systems
  - Commercial cooking equipment systems
  - Means of egress
  - Hot work operations
  - Decorations
  - Portable fire extinguishers
  - Accumulation of rubbish and combustible waste □ Floor Plans
- Sprinkler and Standpipe System Riser Diagram
  - Building Information Card (BIC)
 

*The Building Information Card provides critical building information and floor plans. It summarizes critical facility data relative to occupancy, construction features, fire protection systems, stair/elevator/heating ventilation-air-conditioning systems, hazardous materials, main utility shut-offs, emergency contact information, and a horizontal and vertical view of the building's layout. It provides an important reference for the first responders.*
  - Building Profile
 

*The building profile summarizes significant building information; it is a valuable section for providing an important and quick reference of the premises.*
  - EAP Floor Staffing Charts



## Chapter 2. LEGAL REQUIREMENTS

**This chapter provides summaries of important Laws, Codes or Rules related to the Fire and Life Safety Requirements. All information provided in this chapter is for reference purpose and it won't be tested on the FLS Director school graduation exam or the FDNY FLS Director exams.**

### 2.1 Local Law No. 5 of 1973

(Document link: [https://www1.nyc.gov/assets/buildings/local\\_laws/ll\\_0573.pdf](https://www1.nyc.gov/assets/buildings/local_laws/ll_0573.pdf))

After five (5) fatalities that occurred in two high-rise buildings in NYC in 1970, Local Law 5 was passed in 1973 that amended the Fire Code and the Building Code. It was described as a “Local Law to amend the administrative code of the city of New York, in relation to fire safety requirements and controls in certain office buildings .” The major highlights of the law are summarized below:

#### (1) Fire Safety in Office Buildings

This law requires new occupancy group E buildings (office buildings) and existing office buildings with an occupant load of more than 100 persons above or below the street level or more than 500 persons in the entire building to provide a fire safety plan for fire drill and evacuation procedures. As part of the Fire Safety Plan, Fire Safety Director, Deputy Fire Safety Directors, Building Evacuation Supervisors and FLS Brigades must be provided.

#### (2) Compartmentation and smoke shaft

Refer to Section 2.11 of this booklet.

#### (3) Signs

Refer to Section 2.9 of this booklet.

#### (4) Fire alarm and voice communication systems

Two-way voice communication and fire alarm signal systems are required in high-rise office buildings.

### 2.2 Local Law No. 16 of 1984

(Document link: [https://www1.nyc.gov/assets/buildings/local\\_laws/ll\\_1684.pdf](https://www1.nyc.gov/assets/buildings/local_laws/ll_1684.pdf))

Local Law 16 provided additional fire protection and life safety requirements for new buildings in most occupancy groups and retroactive provisions for existing buildings in most occupancy groups, but primarily buildings in occupancy group J-1 (hotels). It also defines high-rise buildings as a structure 75 feet or more in height. All buildings after 03/27/1986 that are 75 feet or more in height are classified as high-rise buildings. The major highlights of the law are summarized below:

#### (1) Fire protection plan

The fire protection plan is required for all high-rise buildings. The law also outlines the scope of items to be included in the fire protection plan and states that the plan must be approved by the Fire Department.

#### (2) Signs

Refer to Section 2.9 of this booklet.

(3) Emergency power system

The law requires owners of high-rise buildings to provide an emergency power system. This requirement was applicable to buildings built after 03/27/1986 but not retroactively applicable to existing buildings.

(4) Smoke control requirement

It requires many occupancy groups to provide a mechanical system with sufficient capacity to exhaust air. Such systems may either be dedicated fan equipment or the building ventilation system arranged to shut down automatically with manual override capability to exhaust one floor at a time through a roof or an approved location. It also requires owners of existing building in occupancy group J-1 (hotels), either 75 feet or more in height or containing 30 or more sleeping rooms, to comply with additional smoke control requirements.

(5) Automatic sprinklers

New requirements for sprinklers were added for new high-rise buildings and spaces in occupancy group E

(office), F (assembly), G (educational), and J-1(hotels) and certain low rise buildings in occupancy groups E and J-1. Sprinklers are also required in certain existing buildings and spaces in occupancy groups C (mercantile), F, and J-1.

(6) Fire alarm and communication systems

Fire alarm and communication systems and Fire Command Center are required for new high-rise buildings in occupancy groups C (mercantile), new and existing high-rise buildings in occupancy group J-1 (hotels), new and existing low rise building in occupancy group J-1 with 30 or more sleeping rooms, all new high-rise office buildings, and all existing office buildings 100 feet or more in height.

## **2.3 Local Law No. 41 of 1978**

(Document link: <https://www1.nyc.gov/assets/buildings/pdf/pj911.pdf>)

After the tragic fire in the Blue Angel nightclub in midtown Manhattan on December 18, 1975, Local Law No. 41 for the year 1978 was approved “to amend the administrative code of the city of New York, in relation to fire protection for places of assembly.”

This local law requires emergency lighting, sprinklers, and fire alarm signal systems in certain areas of places of assembly. The requirements are for new places of assembly as well as retroactive provisions for existing places of assembly.

## **2.4 Local Law No. 58 of 1987**

(Document link: <http://www.nyc.gov/html/records/rwg/mopd/html/local58.html>)

Local Law 58 of 1987 (LL58) was the first significant change in access to the built environment for people with disabilities in New York City.

LL58 requires design features in new construction and rehabilitation that foster access for people with disabilities. Most dwelling units must be accessible when newly built or be made accessible when altered and be readily adaptable by a resident with disabilities. Non- residential rooms and

spaces intended for the general public and occupant use – including common areas of residential buildings, mercantile, and other business establishments, assembly and educational facilities – must be accessible when newly built or be made accessible when altered. Public toilet rooms, telephones, drinking fountains, parking lot spaces, signs, emergency warning devices, and other facilities are addressed as well. The law provides for exterior and interior accessible routes from the public sidewalk on-site parking and primary entrances to interior rooms, spaces, facilities, etc. and, exterior facilities.

It requires strobes must be provided in general and public floor areas of all buildings where emergency warning system application (fire alarm, smoke detectors etc.) were filed after 1987. It also requires all J-1 (hotels) buildings must provide portable smoke detectors of both audible and visual design.

## **2.5 Local Law No. 26 of 2004**

(Document link: [https://www1.nyc.gov/assets/buildings/local\\_laws/locallaw26of04.pdf](https://www1.nyc.gov/assets/buildings/local_laws/locallaw26of04.pdf))

Based on Local Law 26 of 2004, RCNY 3 §6-02 of 2006 was adopted. The Fire Rule requires that the owner of each office building or occupancy required to have an Emergency Action Plan (EAP) should also designate a Fire Safety/Emergency Action Plan (FS/EAP) Director.

The Rule 6-02 mandates that the owner of a building subject to its requirements be fully prepared to respond to non-fire emergencies. The owner must ensure the development of training and drills as well as procedures for sheltering occupants in place, relocating occupants within the building, and implementing partial and full evacuation. The Rule establishes specific requirements as to the form and content of the EAP. It requires the FS/EAP Director be authorized to implement the EAP.

In 2003, the World Trade Center Building Code Task Force found that compartmentation and smoke alarms do not provide the same level of fire protection as a full system of automatic sprinklers and recommended automatic sprinkler protection throughout all high-rise office buildings. As a result, Local Law 26 of 2004 amended Building Code sections 27-228.5 and 27-929.1 to retroactively require sprinkler protection for existing office buildings measuring 100 feet or more in height by July 1, 2019.

## **2.6 2014 Fire Code and 3 RCNY 113, 2016**

(Document link: <http://www1.nyc.gov/site/fdny/codes/fire-code/fire-code.page>;  
<http://www1.nyc.gov/assets/fdny/downloads/pdf/about/fdny-rules-7-01-15.pdf>)

The 2014 Fire Code (incorporating amendments enacted by Local Law No. 148 of 2013) replaced these two certificates of fitness with a single Certificate of Fitness for a Fire and Life Safety (FLS) Director in both types of occupancies. The new rule (3 RCNY §113-02) implements the new Fire Code requirements by repealing the two rules relating to Fire Safety Director and Fire Safety/EAP Director and replacing them with a new Section 113-02 for FLS Director.

The FLS Director is charged with the responsibility of overseeing the execution of the Comprehensive Fire Safety and Emergency Action (level 1) Plan and all staff training to ensure readiness. The 2014 Fire Code was also updated to cover non-fire emergencies, such as situations involving active shooters and medical emergencies. This rule requires persons applying for an FLS Director Certificate of Fitness to obtain training in these areas.

## 2.7 Americans with Disabilities Act of 1990

(Document link: <https://www.eeoc.gov/eeoc/history/35th/thelaw/ada.html>)

The Americans with Disabilities Act (ADA) became law in 1990. The ADA is a civil rights law that prohibits discrimination against individuals with disabilities in all areas of public life, including jobs, schools, transportation, and all public and private places that are open to the general public.

The purpose of the law is to make sure that people with disabilities have the same rights and opportunities as everyone else. Providing a reasonable accommodation to an individual with a disability is a central concept under the ADA. For example, the ADA requires that all new construction of places of public accommodation, as well as of "commercial facilities" such as office buildings, be accessible by individuals with disabilities. Elevators are generally not required in facilities under three stories or with fewer than 3,000 square feet per floor, unless the building is a shopping center or mall; the professional office of a health care provider; or a public transit station. No individual may be discriminated against on the basis of disability with regards to the full and equal enjoyment of the goods, services, facilities, or accommodations of any place of public accommodation by any person who owns, leases, or operates a place of public accommodation. Public accommodations include most places of lodging (such as hotels), recreation, transportation, education, and dining, along with stores, care providers, and places of public displays.

Emergency preparedness plans should include people with disabilities, and in order to do so effectively, building owners/employers need to establish a process to fulfill requests from individuals with disabilities for reasonable accommodations they may need in emergency situations. Under the ADA requirements, the building owner/employers should ensure people with disabilities the right to communicate with 911/emergency responders, to access emergency evacuation plans, to access transportation, etc.

**The FDNY plan must specify the procedures for identifying occupants who require assistance, and the procedures for providing such assistance.** For example, the list of such occupants must be prepared and maintained in the FDNY plan and the plan must also state which fire brigade members will be designated to assist such occupants.

## Chapter 3. FLS DIRECTOR AND OTHER FLS STAFF DUTIES

All FLS staff listed in the FDNY plan must receive initial training from the FLS Director, including FLS brigade members FLS building evacuation supervisor, FLS wardens and deputy FLS wardens, FLS searchers, all critical operation staff, etc. Refresher training in the FDNY plan from the FLS Director is also required for all FLS staff listed in the FDNY plan to maintain their state of readiness.

Upon implementation of the FDNY plan or during the drills, the FLS Director and all FLS staff must identify themselves to building occupants and others by donning a vest, armband, or other form of identification indicating their role.

### 3.1 FLS Director duties and responsibilities

The Comprehensive Fire Safety and Emergency Action Plan must designate an FLS Director and Deputy FLS Directors who must hold an FLS Director Certificate of Fitness. The FLS Director must have the following duties and responsibilities:

1. The FLS Director must be present in the building at all times during regular business hours, as defined in the FDNY plan. The FLS Director also must be present in a building having an occupant load of more than 500 persons or more than 100 persons above or below the street level (the lowest level of exit discharge). As part of the FDNY Plan, Fire and Life Safety Director, Deputy Fire and Life Safety Directors, Building

Evacuation Supervisors (not required for the Group R-1 buildings), and FLS Brigades must be provided. When the FLS Director is absent during regular business hours, a Deputy FLS Director must be present in the building and must perform the duties of the FLS Director.

When a building other than a Group R-1 transient residential building or occupancy is occupied, but the number of building occupants falls below the level requiring the presence of an FLS Director, the FLS building evacuation supervisor may perform the duties of the FLS Director. The FLS Director must make efforts to ensure that adequate FLS staff is present at the required time and, in the absence of designated staff, must designate interim FLS staff.

2. In the event of a fire, a medical emergency or other non-fire emergency in the building, the FLS Director must
  - report to the Fire Command Center or designated alternative location if the Fire Command Center is compromised;
  - implement such fire safety and/or non-fire emergency actions as are warranted by the circumstances, in accordance with the provisions of the FDNY Plan, the Fire Code, and the Fire Rules;
  - notify arriving emergency response personnel of the nature of the emergency and the response thereto; and
  - comply with the directions of the emergency response personnel and/or other lawful authority.
3. The FLS Director must be fully familiar with the provisions of the FDNY plan and must conduct the FLS staff training and fire and non-fire emergency drills required by the Fire Code. **Exception:** FLS staff training and fire and non-fire emergency drills may be conducted by a person holding a Certificate of Fitness as FEP coordinator or fire drill conductor (W-07/F-07 C of F) under the personal supervision of the FLS Director.

4. The FLS Director must supervise and train the Deputy FLS Director and other FLS staff, including conducting initial and periodic refresher training to maintain the state of readiness of such staff.  
(refer to Section 3.8 of this booklet)
5. The FLS Director must select qualified building personnel for the FLS brigade, organize, train and supervise the FLS brigade and be responsible for the state of readiness of the FLS brigade.
6. The FLS Director must immediately report to 911 any (fire and non-fire) emergency and any determination to implement the FDNY plan.
7. The FLS Director must be responsible for a daily check of the availability of FLS wardens and Deputy FLS wardens (if the wardens are required in the premises) and make such notifications or temporary assignments as are necessary to ensure adequate FLS staffing.
8. The FLS Director is responsible for communicating all information and directions to building occupants in the event of fire and non-fire emergency.
9. The FLS Director must approve the content of the drill educational materials provided to building occupants.
10. The FLS Director must ensure that the required notices are posted on the floors and that the required recordkeeping is maintained
11. The FLS Director must review and approve the procedures established by employers of building occupants to account for building occupants after an evacuation, partial evacuation, in-building relocation, or sheltering in place.
12. The FLS Director must notify the owner of any building occupant that neglects or fails to cooperate with the FDNY plan duties, responsibilities, or obligations.

### **3.2 Deputy FLS Director duties and responsibilities**

The Deputy FLS Director must hold an FLS Director Certificate of Fitness.

In the absence of the FLS Director, the Deputy FLS Director must perform the duties of the FLS Director, except that the FLS Director must personally supervise all FLS staff training.

In the presence of the FLS Director, the Deputy FLS Director must assist the FLS Director in carrying out the requirements of the FDNY plan and the Fire Code/Fire Rules.

### **3.3 FLS brigade**

They must perform their designated assignment as set forth in the FDNY plan or as directed by the FLS Director.

FLS brigade members must be on duty during regular business hours. The FLS Director and Deputy FLS Director cannot be designated as FLS brigade members.

In the event of an (fire or non-fire) emergency, FLS brigade members must immediately report to the designated locations, as set forth in the FDNY plan or directed by the FLS Director, to be ready to undertake their designated assignments.

The FLS brigade members are currently separated into two categories: fire safety brigade member and non-fire safety (EAP) brigade member. A person may be designated as a fire and non-fire (EAP) brigade member. A person may be designated as both fire and non-fire (EAP) brigade member.

The fire safety brigade members can be different building staff such as building manager, porter, security guard, etc. A sufficient number of fire safety brigade members must be listed to exercise the authority and perform the following duties: implement evacuation of floors, control small fires, coordinate communications with Fire Command Center, remain on the floor below the fire to provide information to responding firefighters and coordinate assistance to building occupants with special needs.

The non-fire safety brigade members (EAP brigade members) must consist of the building manager, chief engineer, and director of security (or, in their absence, qualified designees), and other building personnel, office employees, or other building occupants designated to assist in the implementation of the FDNY plan, including persons assigned to assist building occupants that require assistance to participate in the plan.

### **3.4 FLS building evacuation supervisor**

This FLS building evacuation supervisor is currently only required in the Comprehensive Fire Safety and Emergency Action Plan for office buildings.

At least one person as an FLS building evacuation supervisor, and qualified to serve in such position, must be present and on duty in the building at all times when an FLS Director is not required to be on duty, but there are occupants in the building. The building evacuation supervisor at such times must exercise the authority and responsibility of the FLS Director to implement the FDNY plan.

In the presence of the FLS Director, FLS building evacuation supervisor should assist the FLS Director in carrying out the requirements of the FDNY plan.

### **3.5 FLS warden and deputy FLS warden**

The FLS wardens and deputy FLS wardens are currently only required in the Comprehensive Fire Safety and Emergency Action Plan for office buildings.

#### **3.5.1 FLS warden**

One FLS warden is required for each floor of the building. FLS wardens must be on duty on each floor during regular business hours for such floor.

The FLS wardens must:

- be familiar with the FDNY plan, including:
- general sheltering in place, in-building relocation, partial and fully evacuation procedures,
- the exit and in-building relocation routes to be utilized for the floor,
- the location of in-building relocation areas;
- the means of communicating with the FLS Director;
- in the event of a fire or non-fire emergency on the floor or immediately affecting building occupants on the floor, notify the FLS Director (through the warden phone) and building occupants on the floor of the  
(fire or non-fire) emergency and initiate appropriate action;

- in the event of a fire or non-fire emergency not on the floor or not immediately affecting building occupants on the floor, establish communication with the FLS Director (through the warden phone) and, if possible, await direction from the FLS Director;
- keep the FLS Director informed of his or her location and the progress of the implementation of FDNY plan measures;
- confirm the in-building relocation or evacuation of the floor or portion thereof by directing Deputy FLS wardens and/or other FLS staff designated as FLS searchers to search all areas of the floor to be relocated in building or evacuated; to do so by visual inspection, not merely by the lack of a voice response; and to notify any remaining building occupants that they must immediately comply with the applicable FDNY plan procedures;
- determine whether the stairways are safe to enter before directing building occupants to use them, and, if unsafe, notify the FLS Director;
- instruct building occupants not to use elevators in the event of fire; and
- perform such other duties as set forth in the FDNY plan or as directed to do so by the FLS Director.

### **3.5.2 Deputy FLS warden**

At least one deputy FLS warden is required for each employer of building occupants on a floor. If the floor area occupied by an employer of building occupants on a single floor exceeds 7,500 square feet, a deputy FLS warden must be designated for each 7,500 square feet or portion thereof. No individual deputy FLS warden is allowed to be designated for more than 7,500 square feet of building floor area. At least the minimum required number of deputy FLS wardens must be on duty on each floor during the regular business hours of such employer.

In the absence of the FLS warden, a deputy FLS warden needs to perform the duties of the FLS warden.

In the presence of the FLS warden, deputy FLS wardens are required to assist the FLS warden in carrying out the requirements of the FDNY plan and the Fire Code/Fire Rule, by searching all areas of the floor to be relocated in building or evacuated, and notifying any remaining building occupants that they must immediately comply with the applicable FDNY plan procedures, and performing such other duties as assigned by the FDNY plan or directed by the FLS warden.

### **3.6 FLS searchers**

The FLS searchers are currently only required in the Comprehensive Fire Safety and Emergency Action Plan for office buildings.

At least one male and one female FLS searcher are required for each employer of building occupants on a floor.

Such FLS searchers must be on duty on each floor during the regular business hours of such employer

In the absence of the deputy FLS warden, the FLS searcher must perform the duties of the deputy FLS warden.

In the presence of the deputy FLS warden, the FLS searcher must assist the FLS warden in carrying out the requirements of the FDNY plan and the Fire Code/Fire Rules, by searching all areas of the floor to be relocated in building or evacuated, notifying any remaining building occupants that they must immediately comply with the applicable FDNY plan procedures, and performing such other duties as assigned by the FDNY plan or directed by the FLS warden.



### **3.7 Critical operations staff**

The critical operations staff is currently only required to be listed in the Comprehensive Fire Safety and Emergency Action Plan for office buildings.

Critical operations staff are the building personnel or other building occupants designated to remain after the FDNY plan is implemented to perform or shut down critical operations, or perform essential services, before they shelter in place, relocate in building or evacuate. Such staff must be designated based on the critical nature of their duties, either to the operation of the building service equipment or other essential services. The FDNY plan must identify each such individual and the essential service that the individual is required to perform even under emergency conditions. Employers of building occupants may request that the FLS Director designate certain office employees as critical operations staff. Such requests must be granted only if the employer can demonstrate that the employee is performing a public safety function or essential service for the employer in which there is a compelling public interest in maintaining even in the event of an emergency. All requests and designations must be documented in writing and made available for inspection by Fire Department representatives, upon request.

In the event of any (fire or non-fire) emergency, critical operations staff must immediately report to their designated locations as set forth in the FDNY plan or directed by the FLS Director, and undertake their designated assignments.

### **3.8 FLS staff training requirements**

All FLS staff members must be trained to be familiarized with their duties and appropriate fire prevention measures for the occupancy. The FLS staff training must be in the form of live instruction but may be supplemented by video presentations and/or distribution of other educational materials. Training may be conducted in the form of computerized training, without live instruction, provided that such computerized training is interactive, includes an evaluation of the FLS staff members' understanding of the training materials, and is not conducted in lieu of live instruction for more than one-half (½) of the required FLS staff training sessions per year.

#### **3.8.1 Initial training**

- (1) All FLS staff listed on the FDNY plan must receive initial training in the FDNY plan from the FLS Director, including FLS brigade members, FLS building evacuation supervisors, FLS wardens and deputy FLS wardens, FLS searchers, all critical operations staff, etc. upon their designation as FLS staff.
- (2) Such training must familiarize the FLS staff with duties and appropriate fire prevention measures for the occupancy.
- (3) During the training, the FLS Director must cover the following basic topics:
  - A general overview of the FDNY plan (same information must be learned by all FLS staff members)
  - EAP concepts (same information must be learned by all FLS staff members)
  - Duties during the fire and non-fire emergencies (different information for different FLS titles)

During the On-Site Exam, all FLS Director candidates will be required to present an initial training session for one of the following staff members: (1) FLS brigade members (for hotel buildings and office buildings); (2) FLS building evacuation supervisors (only for office buildings); (3) FLS floor wardens (only for office buildings). The staff member will be designated by the FDNY inspector upon the On-Site Exam.

## **(1) General overview of the FDNY plan**

### **(a) Locations of exits, stairways, elevators, and primary and alternate exit routes**

\*Examples of exits: (this is only an example!)

- There are two exits in the building, one located at 1st Ave and another one located at Smith street.

\*Examples of stairway: (this is only an example!)

- Stairway "A," southwest corner, floors served: basement to 10th floor.
- Stairway "B," east side, floors served: basement to 12th floor.

\*Examples of elevators: (this is only an example!)

- Elevator bank "L," west side, floors served: basement to 12th floor.
- Elevator bank "M," southeast side, floors served: ground floor to 12th floor.

\*Example of the primary and alternate exit routes (only for office buildings): (this is only an example!)

- If partial or full evacuation is implemented, all building occupants should be evacuated through the designated exit routes.

For ground floor to 12th floor, the primary exit route is stairway "B" and the exit terminates on 1st Ave. The secondary exit route is stairway "A" and the exit terminates on 1st Ave.

For the basement, the primary exit route is stairway "C" and the exit terminates on Smith street; the secondary exit route is stairway "D" and the exit terminates Smith Street.

### **(b) Fail-safe device**

Explain which stairway doors are locked in the building and how to unlock them during emergencies. Explain fail safe system and when a fail-safe release device will operate.

### **(c) Locations of manual pull stations, when and how to activate them**

Identify every location of the manual pull stations in the building. Explain how to operate a manual pull station and indicate whether it sends a signal to a central station or only rings in the building. Emphasize that the manual pull station is to be used only when fire or smoke conditions are actually observed, and not merely when there is the odor of smoke. Explain that using the manual pull station in the absence of observable flames or smoke can confuse emergency responders as to the location of the fire, given that smoke can quickly travel throughout the building. Also explain that the manual pull stations are not to be used during an active shooter emergency or to notify others of any other non-fire emergency, as doing may cause building occupants to enter the stairways and/or evacuate the building when they should be sheltering in place.

### **(d) Locations of assembly areas**

\*Example: (You should use the information provided in your building's FDNY plan)

Once the partial or full evacuation is implemented, you should know the primary assembly area which is located on the 2nd Ave between Smith Street and John Road. You should also know the secondary assembly area which is located on the Queens Ave between John Road and Mark Place.

(e) **Locations of in-building relocation areas (for fire and non-fire emergencies)**

\*Example: (You should use the information provided in your building's FDNY plan)

Once the in-building relocation is implemented, you should know all in-building relocation areas in our building.

The in-building relocation areas on all floors including basement are located at the elevator lobby of each floor.

(f) **The fire alarm system and method of communication**

Introduce how the fire alarm system installed in your building will be activated and how it is used to notify building occupants of fires:

The FLS staff should know whether the fire alarm system in your building will activate throughout the building, or only on the fire floor, floor above, and/or floor below in the event of fire.

The FLS staff should also know how the building occupants will be notified of a fire (e.g. siren, strobe lights, voice announcement, etc.)

The FLS staff should also know how to communicate with the Fire Command Center, for example, using warden phones or other telephones that directly communicate with the Fire Command Center, etc. Explain the location of the communication devices and how to operate them.

(g) **Procedures for accounting for building occupants after competing in-building relocation, partial evacuation, or full evacuation and the method of communication. (Currently, this may only apply to the office buildings)**

\*Example: (You should use the information provided in your building's FDNY plan)

You should know the procedures for accounting for employees present in the building and taking a head count at the in-building relocation area or the assembly area.

After implementation of an in-building relocation, the responsible staff assigned by the FDNY plan (such as

FLS Wardens) should take a head count at the relocation area. The responsible staff should call to the Fire Command Center via the fire warden phone to report if all the floor occupants are in the relocation area and to report the number of occupants in the area. For any occupant not accounted for, a list of the names and last known locations must immediately be established.

After completing a partial or full evacuation, the responsible staff assigned by the FDNY plan (such as FLS Wardens) should take a head count at the assembly area. For any occupant not accounted for, a list of the names and last known locations must immediately be established. The staff should call the FLS Director via cell phone to report. In an evacuation, do not return to the building. All building occupants should remain with their group unless otherwise instructed.

**(2) Four non-fire emergency (EAP) actions**

Discuss the 4 non-fire emergency (EAP) actions (shelter in place, in-building relocation, partial evacuation and full evacuation) dealing with an emergency as listed in the FDNY plan. The FLS Director must cover the definitions of the 4 non-fire emergency (EAP) actions. (Refer to chapter 15 of this booklet)

### **(3) Duties of FLS staff**

#### **(a) FLS brigade members (required in Hotels and office buildings)**

Each brigade member must be familiar with the FDNY plan, and be trained to carry out specific duties and responsibilities during a fire, non-fire drill or any emergency. Although a person may be designated as a non-fire safety brigade member but not a fire safety brigade member, the FLS Director should train all FLS brigade members in all possible duties, including duties in the event of fire and non-fire emergencies.

**In the event of fire/smoke condition or the activation of a fire alarm**, the brigade members must determine location of the fire and direct the evacuation of the floor in accordance with directions received and the following guidelines:

- The brigade members on the fire floor must, as soon as practicable, notify the Fire Command Center of the situation.
- Report to the floor below the fire to assist in evacuation and provide information to the Fire Command Center.
- Before entering the fire floor, brigade members must verify it is safe to do so. After evacuation of fire floor, try to control spread of fire by closing doors, etc.
- Attempt to control the fire (by using a fire extinguisher) until arrival of the Fire Department, if the fire is small in size and the fire conditions do not pose a personal threat. If the door is hot or smoke is visible, no one should attempt to enter that area/space. (Note: The FLS Director should teach the brigade members how to operate the fire extinguisher by introducing "P.A.S.S." and instruct the brigade member that fire extinguishers are important in stopping a small fire from becoming a larger fire. Portable extinguishers are not intended to fight large or spreading fires. By the time the fire has spread, portable fire extinguishers will not be enough to kill the fire. Such fires should be extinguished by the building fire extinguishing systems or trained firefighters only).
- Evacuation procedures:
  - Brigade members must know the building's evacuation procedures and the evacuation location.

Buildings may have different evacuation procedures defined in the FDNY plan.

- The most critical areas for immediate evacuation are the fire floor and floors immediately above (and floor below if appropriate) in a non-combustible building. Evacuation from the other floors must be initiated when instructions from the Fire Command Center or conditions indicates such action. Brigade members must direct the occupants not to use elevators. Evacuation should be implemented via uncontaminated stairs. Brigade members must try to avoid stairs being used by the Fire Department.
- Evacuation or relocation to another safe area at least three (3) floors below their present location is generally adequate. Fire brigade members must check the environment in the staircase prior to entry for evacuation. If it is affected by smoke, an alternate stairway must be selected, and the Fire Command Center must be notified. The brigade members must keep the Fire Command Center informed of the means being employed for

evacuation by the occupants of the floor. Brigade members must see that all occupants are notified of the fire and the occupants follow the evacuation instructions.

- Brigade members must keep the Fire Command Center informed regarding their location.
- Assist the Fire Department:
- If safe to do so, one brigade member should stay on the floor below the fire to direct the Fire Department to the fire location and to inform them of conditions.
- Upon arrival of the Fire Department, if safe to do so, the brigade members must report to the Fire Command Center for additional instructions.

**In the event of a non-fire emergency:**

The brigade members must immediately report to the designated locations, as set forth in the FDNY plan or directed by the FLS Director, to be ready to undertake their designated assignments and must immediately communicate with the Fire Command Center. The FLS Director may need to gather information from the brigade members to decide if the emergency action plan should be implemented. Once the emergency action plan has been implemented, the brigade members must assist in the implementation of the plan, as set forth in the FDNY plan or directed by the FLS Director. Instruct building occupants not to use elevators unless and until the FLS Director authorizes their use. DO NOT activate the manual pull station for a non-fire emergency.

**(b) FLS wardens and deputy FLS wardens (only applies to office buildings)**

Each warden and deputy warden must be familiar with the FDNY plan, and be trained to carry out specific duties and responsibilities during a fire, non-fire drill, or any emergency.

**In the event of fire/smoke condition or the activation of a fire alarm,** the floor wardens must:

- Report to the FLS warden phone when an alarm activates on their floor, the floor above and the floor below (if applicable). They must call the Fire Command Center and inform the FLS Director of the conditions on the floor and if there is smoke and/or fire.
- Direct the evacuation of the occupants of their floor during a fire. They must know how to determine if it is safe to enter the stairway. Check doors with the back of hand before opening them. If door or knob is hot, don't open it. If it feels cool, brace the door with a foot and open slightly to look for smoke and feel for heat. If the air appears to be cool, it should be safe to enter the stairway.
- Confirm the in-building relocation or evacuation of the floor or portion thereof by directing deputy FLS wardens and/or other FLS staff designated as FLS searchers to search all areas of the floor to be relocated in building or evacuated; to do so by visual inspection, not merely by the lack of a voice response; and to notify any remaining building occupants that they must immediately comply with the procedures;
- **Evacuation procedures:**
- FLS wardens must know the building's evacuation procedures and the evacuation location. The most critical areas for immediate evacuation are the fire floor and floors immediately above (and floor below if applicable) in a non-combustible building. Evacuation from the other floors must be instituted when instructions from

the Fire Command Center or conditions indicate such action. FLS warden members must direct the occupants not to use elevator unless directed by FDNY firefighting personnel or the FLS Director. Evacuation should be via uncontaminated stairs. FLS wardens must try to avoid stairs being used by the Fire Department. If this is not possible, they must try to attract the attention of the Fire Department personnel before such personnel open the door to the fire floor.

- Evacuation or relocation to another safe area at least three (3) floors below their present location is generally adequate. FLS wardens must keep the Fire Command Center informed regarding their location. Floor wardens must check the environment in the stair prior to entry for evacuation. If it is affected by smoke, an alternate stairway must be selected, and the Fire Command Center must be notified. FLS wardens must keep the Fire Command Center informed of the means being employed for evacuation by the occupants of the floor.
- FLS warden must re-contact the FLS Director after the relocation/evacuation and inform the FLS Director of their location.

**In the event of a non-fire emergency, the floor wardens must**

- in the event of an emergency on the floor or immediately affecting building occupants on the floor, notify the FLS Director and building occupants on the floor of the emergency, and initiate appropriate action.
- in the event of an emergency not on the floor or not immediately affecting building occupants on the floor, establish communication with the FLS Director and, if possible, await direction from the FLS Director;
- keep the FLS Director informed of his or her location and the progress of the implementation of emergency action plan measures;
- confirm the in-building relocation or evacuation of the floor or portion thereof by directing deputy FLS wardens and/or other FLS staff designated as FLS searchers to search all areas of

the floor to be relocated in building or evacuated; to do so by visual inspection, not merely by the lack of a voice response; and to notify any remaining building occupants that they must immediately comply with the applicable emergency action plan procedures;

- determine whether the stairways are safe to enter before directing building occupants to use them, and, if unsafe, notify the FLS Director, and instruct building occupants not to use elevators unless and until the FLS Director authorizes their use;
- DO NOT to activate the manual pull station for a non-fire emergency
- perform such other duties as set forth in the FDNY plan, or as directed to do so by the FLS Director.

**(c) FLS building evacuation supervisor (only applies to office buildings)**

When an FLS Director is not required to be on duty, but there are occupants in the building (e.g. nights, weekends, holidays, etc.), the building evacuation supervisor at such times must exercise the authority and responsibility of the FLS Director to implement the FDNY plan. If an FLS Director is on duty, the building evacuation supervisor has to assist the FLS Director.

The FLS building evacuation supervisor must be familiar with the FDNY plan. The FLS Director must train the personnel to recognize the fire alarm signal of the fire alarm panel. The FLS Director also must train the personnel how to make announcements from the Fire Command Center and how to maintain communication with FLS brigade members. The FLS Director also must train the personnel to be familiar with 4W's about making announcements for implementing the emergency action plan during a non-fire emergency.

The 4W's announcement must include.

- What has occurred
- Where it has occurred
- What provisions of the non-fire emergency action plan will be implemented (inform the occupants of the appropriate actions to follow)
- Why they are being instructed to follow the non-fire emergency actions (explain why the actions are necessary)

**During the non-regular business hours, in the event of fire/smoke condition or the activation of a fire alarm, the FLS building evacuation supervisor must:**

- Report to the Fire Command Center.
- Immediately call 911 and report fire and (if known) fire location.
- Gather information from FLS brigade members (if available).
- Identify stairway(s) for evacuation of building occupants and stairway(s) for use by responding first responders. If any stairway door is locked, the FLS building evacuation supervisor must ensure the failsafe device has been released.
- Make announcement to building occupants informing them of the fire condition and its location. Instruct them not to use the elevators unless directed to do so by first responders.
- Instruct building occupants on the effected floors to immediately leave these floors, and evacuate the building or relocate to another safe location within the building at least three floors below their present location. In a non-combustible building, the most critical affected floors are the fire floor, the floor immediately above, and the floor below (if applicable). Direct them to use the designated stairway(s) or other routes of egress.
- Instruct occupants to close office doors and stairway doors behind them.
- Monitor the progress of the fire and smoke conditions by monitoring the fire alarm control panel and maintaining regular communication with FLS brigade members (if available).
- Ensure the HVAC system has been shut down. Consult with the building engineer (if available).
- Notify arriving FDNY firefighting personnel and other first responders of the nature of the emergency and the actions already taken. Provide the required material (Floor plans, BIC, FDNY plan, elevator and stair diagrams, elevators keys, other master keys/access cards, and premises security radios/walkietalkies) to FDNY firefighting personnel.

**During the non-regular business hours, in the event of a non-fire emergency, the FLS building evacuation supervisor must:**

- Report to the Fire Command Center.
- Immediately call 911 and report the emergency and (if known) location.
- Gather information from FLS brigade members (if available).
- Identify stairway(s) for building occupants and stairway(s) for use by responding first responders.
- Implement the emergency action plan, if appropriate. Call 911 to report that the plan has been implemented.
- Notify arriving first responders of the emergency and the building response Make announcement to building occupants informing them of the emergency condition and direct them to implement the emergency action plan.

**(d) FLS searchers and critical building operation staff (only applies to office buildings)**

Refer to Section 3.6 and 3.7 of this booklet.

**3.8.2 Refresher training**

All FLS staff must receive refresher training in the FDNY plan from the FLS Director, including deputy FLS

Director, FLS brigade members, FLS building evacuation supervisor, FLS wardens and deputy FLS wardens, FLS searchers, all critical operation staff listed on the FDNY plan, etc. to maintain their state of readiness.

**3.8.3 Duration and frequency of training**

The Fire Department recommends that the FLS staff participate in the training designed to familiarize them with their duties pursuant to the plan in accordance with the frequency set below:

FLS staff member	Initial training duration		Refresher training duration & frequency	
	Fire safety	Non-fire emergency	Fire safety	Non-fire emergency
Deputy FLS Directors	Require FLS Director C of F	Require FLS Director C of F	<ul style="list-style-type: none"> <li>• 1 hour quarterly for Group A;</li> <li>• 1 hour quarterly for Group R-1 (per shift);</li> <li>• 1 hour annually for all other occupancies</li> </ul>	1 hour semiannually
FLS building evacuation supervisor	2 hours	3 hours		1 hour semiannually
FLS wardens and deputy wardens	1 hour	2 hours		1 hour annually
FLS brigade members	1 hour	2 hours		1 hour annually
All other FLS staff	1 hour	2 hours		1 hour annually



## Chapter 4. FIREMATICS

(This section was cited from

1. Fire Dynamics, National Institute of Standards and Technology, US Department of Commerce. <https://www.nist.gov/%3Cfront%3E/fire-dynamics>
2. A Reporter's Guide to Fire and the NFPA. National Fire Protection Association. <http://www.nfpa.org/news-and-research/news-and-media/press-room/reporters-guide-to-fire-andnfpa/all-about-fire>)

### 4.1 Chemistry and properties of fire and ignition source

Fire is not a substance but a rapid oxidation process, which is a chemical chain reaction resulting in the evolution of light and heat in varying intensities (NFPA 921). The fire triangle identifies the three needed components of fires: fuel (something that will burn), heat (enough to make the fuel burn) and oxidizing agent (air or oxygen).



Fire can also be explained in terms of the Fire Tetrahedron - a geometric representation of what is required for fire to exist, namely, fuel, an oxidizing agent, heat (or ignition source), and an uninhibited chemical chain reaction.

Fuel is any kind of combustible material that can burn. It is characterized by how easily that fuel will burn. Fuel sources include combustible materials (such as wood, paper, trash etc.), flammable/combustible liquids (such as gasoline, solvents, diesels, etc.) and flammable gases (such as propane or natural gas)

An oxidizing agent supports combustion but does not burn. The most known and common oxidizing agent is oxygen. But a fire can still burn when another oxidizing agent is present, such as nitrates, chlorine, etc.

A heat source is responsible for the initial ignition of fire, and heat is also needed to maintain the fire and permit it to spread. Heat allows fire to spread by removing the moisture from nearby fuel, warming surrounding air, and preheating the fuel in its path, enabling it to travel with greater ease. Ignition sources can include any material, equipment or operation that emits a spark or flame including obvious items, such as torches, as well as less obvious items, such as static electricity and grinding operations. Equipment or components that radiate heat, such as kettles, catalytic converters, and mufflers, also can be ignition sources.

Once a fire has started, the resulting exothermic chain reaction sustains the fire and allows it to continue until or unless at least one of the elements of the fire is blocked.

If you take any of these four things away, there will be no fire or the fire will be extinguished. Fire safety is based upon the principle of keeping fuel sources and ignition sources separate.

Consider a trash can fire. The fire will be stopped by any of the following:

- (1) Keep the fire contained and all combustible materials are removed or burned out (remove the fuel)
- (2) The flame is covered completely (remove the oxygen)

- (3) Application of water (cool the burning material and, remove the heat)
- (4) Applying extinguishing agents/chemicals to the fire (break the chemical chain reaction)

## 4.2 Behavior of fire and heat transfer

Fire behavior is commonly defined as the manner in which fuel ignites, flame develops, and fire spreads and exhibits other related phenomena as determined by the interaction of fuels, weather, and topography.

### 4.2.1 Stages of fire

1. **Incipient:** Fuel, oxygen, and heat join together in a sustained chemical chain reaction. At this stage, a fire extinguisher can control the fire.
2. **Growth:** With the initial flame as a heat source, additional fuel ignites. Convection and radiation ignite more surfaces. The size of the fire increases, and the plume reaches the ceiling. Hot gases collecting at the ceiling transfer heat, allowing all fuels in a room to come closer to their ignition temperature at the same time.
3. **Fully developed:** Fire has spread over much if not all the available fuel; temperatures reach their peak, resulting in heat damage. Oxygen is consumed rapidly.
4. **Decay (Burnout):** The fire consumes available fuel, temperatures decrease, and fire gets less intense.

### 4.2.2 Heat transfer and fire spreads

Heat transfer is a major factor in the ignition, growth, spread, decay, and extinction of fire. Heat energy always flows from hotter to colder.

Fire spreads by transferring the heat energy from the flames in three different ways.

- **Conduction:** The passage of heat energy through or within a material because of direct contact, such as a burning wastebasket heating a nearby couch, which ignites and heats the drapes hanging behind, until they too burst into flames.
- **Convection:** The flow of fluid or gas from hot areas to cooler areas. The heated air is less dense, and rises, while cooler air descends. A large fire in an open area produces a plume or column of hot gas and smoke high into the air. But inside a room, those rising gases encounter the ceiling. They travel horizontally along the ceiling forming a thick layer of heated air, which then moves downward.
- **Radiation:** Heat traveling via electromagnetic waves, without objects or gases carrying it along. Radiated heat goes out in all directions, unnoticed until it strikes an object. Burning buildings can radiate heat to surrounding structures, sometimes even passing through glass windows and igniting objects inside.

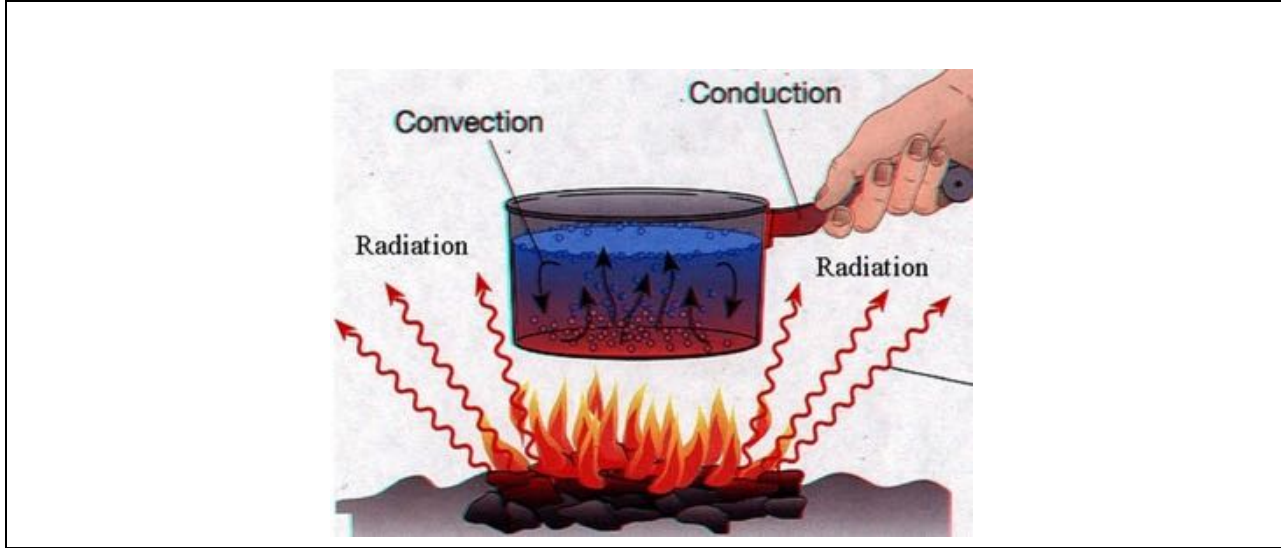
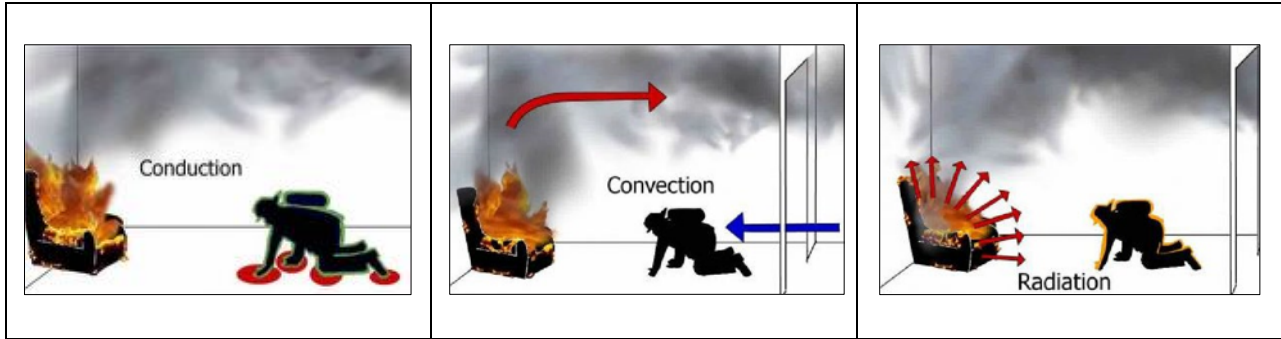

**4.2.3 Fire behavior in a structure**

In this case the fire starts in a structure which has the doors and windows closed. Early in the fire growth stage there is adequate oxygen to mix with the heated gases, which results in flaming combustion. The size, shape and arrangement of fuel (combustible materials in the structure) will affect combustibility and fire spread. As the oxygen level within the structure is exhausted, the fire decays and the heat release from the fire decreases and as a result the temperature decreases.

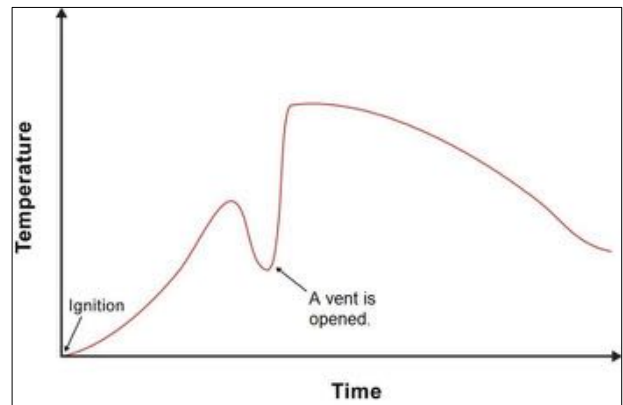

When a vent is opened, such as when the fire department or a civilian enters a door, oxygen is introduced.

The oxygen mixes with the heated gases in the structure and the energy level begins to increase. This change in ventilation can result in a rapid increase in fire growth potentially leading to a flashover (fully developed compartment fire) condition.

#### 4.2.4 Special fire dangers on structure fires

**Rollover (Flameover)** occurs when ignited fire gases, or incompletely burned fuels, rise to the ceiling, and spread out horizontally. Then smoke appears to suddenly start burning. This situation should call for aggressive cooling of atmosphere immediate exit or immediate ventilation. If nothing is done to ventilate the room or cool the air, this condition leads to flashover.



**Flashover** is the sudden, simultaneous ignition of everything in a room. This is the most dangerous stage of fire development. This is how it happens:

- Hot gases rise to the ceiling and spread out across to the walls.
- Heat radiates downward and intensifies until all combustible items reach their ignition temperatures and burst into flames.
- Temperatures soar to as much as 1,000 degrees



Fahrenheit in a few seconds. Even a firefighter in full protective gear is unlikely to survive a flashover.

- Firefighters are trained to recognize the signs that flashover is about to occur: dense black smoke with tightly packed curls ("black fire"); dense black smoke that pushes out of a doorway or window opening; smoke that has accumulated as low as a doorknob with the fire seen below.

**Backdraft** is an explosion that occurs when oxygen is introduced into a room full of hot gases.

- A fire burning in a confined area consumes all the oxygen.
- Visible flames disappear. Solid fuels smolder and hot flammable gases accumulate and fill the room.
- The temperature increases, the gases expand, and pressure builds, pulsing against doors and windows. From outside, the building may look like it is breathing or throbbing.
- If an opening is made to admit oxygen, the hot vaporized fuel bursts into flames, and the pressurized gases explode through the opening, resulting in a rolling fireball.



## Chapter 5. BUILDING CONSTRUCTION AND PRIMARY FIRE PROTECTION SYSTEMS

The FLS Directors, who typically have important responsibilities relating to building operation and maintenance, must be familiar with applicable Fire Code requirements.

FLS Directors who are knowledgeable in Fire Code building operation and maintenance requirements will help foster compliance with the Fire Code in the buildings where they are employed, thereby making the building a safer place for occupants and emergency responders. In order to help ensure the reliability of fire protection systems and other fire safety-related building systems, the Fire Code prescribes minimum periodic inspection, testing and other maintenance requirements for such systems and in many cases requires persons performing such responsibilities to obtain a Certificate of Fitness. The table below identifies several of the more common building related certificates.

### Relevant Certificate of Fitness/Certificate of Qualification List

Type	Description	Personal/General	Premises Related or Citywide
B-29	Supervision of Battery Systems	General	Premises related
F-01	Citywide Fire Guard for Impairment	Personal	Citywide
F-07/W-07	Fire and Non-Fire Emergency Drill Conductor	Personal	F-07: Premises related W-07: Citywide
F-60	Fire guard for torch operation and fire guard for construction site.	Personal	Citywide
F-89	Fire and Life Safety Director	Personal	Premises related
G-60	Torch operation	Personal	Citywide
P-64/F-64 /W-64	Commercial Kitchen Exhaust System Cleaning Technician	Personal	P-64/W-64: Citywide F-64: Premises related
Q-01/Q-99	Refrigeration system operating engineers	Personal	Premises related
S-12	Citywide Sprinkler System	Personal	Citywide
S-13	Standpipe System (except multi-zone system)	Personal	Citywide
S-14	Standpipe System, multi-zone	Personal	Premises related
S-15	Supervision of Foam-Water Sprinkler Systems	Personal	Citywide
S-78/F-78	Inspection, Cleaning & Testing of Smoke Detectors	Personal	S-78: Citywide F-78: Premises related
S-96	Sales of Portable Fire Extinguisher	Personal	Citywide
S-95	Supervision Of Fire Alarm Systems	Personal	Premises related
S-97/S-98	Inspection, Testing and Servicing of Fire Alarm Systems	Personal	Citywide
T-89	Temporary Fire and Life Safety Director	Personal	Premises related
W-97	Fumigation and insecticidal fogging operation	Personal	Citywide
W-96	Portable Fire Extinguisher Servicing	Personal	Citywide

## 5.1 High rise building features and construction

### 5.1.1 High rise building features and construction

According to 1968 Building Code, any building with an occupied floor located more than 75 feet above the street level is defined as a high-rise building. Before a building is constructed, plans need to be submitted to the Building Department to ensure that all regulations will be complied with. When the plans are submitted, they have to include a determination of how the building will be used as a whole. If different floors or spaces will have different uses or activities taking place (e.g. theaters on 1-4 floors, offices on 5-7 floor and a hotel on 8-20 floors), then those spaces also have to be identified in the plans. Individual locations within the building can be designated for different uses. Building occupancy and construction classification is based the usage of the building or individual spaces. A Certificate of Occupancy (C of O) states a building's legal use and/or type of permitted occupancy. New buildings must have a C of O, and existing buildings must have a current or amended C of O when there is a change in use, egress, or type of occupancy. No one may legally occupy a building until the Building Department has issued a Certificate of Occupancy or Temporary Certificate of Occupancy. The Building Department issues a final Certificate of Occupancy when the completed work matches the submitted plans for new buildings or major alterations. These documents confirm the work complies with all applicable laws and all necessary approvals have been received from other city agencies. The 1968 Building Code classified the buildings into 9 categories and the 2008 Building Code classified the new buildings into 10 categories using different letter designation. The categories are listed on the following page.

<b>Occupancy groups</b>	<b>1968 Building Code</b>	<b>2008/2014 Building Code</b>
Assembly	F	A
*Business	E	B
Educational	G	E
Factory and Industrial	D	F
High Hazard	A	H
Institutional	H	I
Mercantile	C	M
Residential	J	R
Hotels	J-1	R-1
Apartment Buildings	J-2	R-2
Storage	B	S
Utility and Miscellaneous	N/A	U

\*Business buildings may include banks, civic administration buildings, office spaces, neighborhood family care centers, medical offices, adult educational facilities (above 12<sup>th</sup> grade).

Different construction, Building and Fire Code requirements may apply to different building occupancies. A building that is used for two or more occupancies, classified within different occupancy groups, must be considered a mixed occupancy building. Mixed occupancy building may need to comply with different fire safety regulations depending on the occupancy groups.

Because of the size of high-rise buildings, most high-rise office buildings and hotels are constructed with noncombustible materials with at least a two-hour fire resistance rating. The C of O of your building will indicate the building construction category and the fire resistance rating requirement.

Buildings built in different years may comply with different Building Code requirements. As an FLS Director, you must be familiar with your building systems and the designs that are related to fire safety issues.

## 5.2 Fire alarm systems

### 5.2.1 Introduction

A fire alarm system is a system arranged to monitor and annunciate the status of fire alarm or supervisory signal initiating devices, and to initiate the appropriate response to these signals. Fire alarm systems are required in many premises as part of a fire protection system. The new Fire Code has expanded the requirements for fire alarm systems which include but are not limited to the following buildings:

- office buildings
- shelters
- hospitals
- mercantile (retail)
- hotels
- motels
- schools
- apartment buildings which may be high-rise or low-rise, or as specified in New York City building code section 309.1.

Any FDNY approved fire alarm system must be supervised by a Certificate of Fitness holder depending upon the nature of the occupancy and/or the type of fire alarm system. See the table below for various examples.

<b>Fire alarm system and/or building occupancy</b>	<b>C of F requirement</b>
Fire alarm system has two-way voice communication system with warden phone	FLS Director (F-89/T-89)
Fire alarm system installed in a high rise building	FLS Director (F-89/T-89)
Fire alarm system with one and/or two-way communication, installed in a hotel building containing 50 or more sleeping rooms	FLS Director (F-89/T-89)
Fire alarm system in a homeless shelter not requiring an FLSD	F-80
Fire alarm system with one-way communication system (public announcement system), not requiring an FLS Director/F-80	S-95
Fire alarm system without voice communication system and not requiring an F-80 (e.g. day care)	S-95



It is UNLAWFUL to install or maintain any fire protection system or device that has the physical appearance of fire protection equipment but that does not perform a fire protection function. The law prevents those devices from being confused with actual fire protection equipment. Examples are shown below:



Dummy Smoke Detector  
Hidden Video Camera



A CCTV camera that is installed inside a  
shell

that resembles a sprinkler head

### **5.2.2 Building classes for fire alarm systems**

Buildings that were built before 2008 and were considered to be high rises and required voice communication systems fell under two main categories called Class-J (class J system, modified class J system, and modified class J-1 system) and Class-E (Class E system, modified class E system, and mini-class E systems). The 2008 Building Code requires a voice communication system for most buildings that meet the definition of a high rise building including Class-B and Class-R.

Occupancy group R-1 (previous known as J-1) (e.g. Hotels) includes buildings and spaces that are primarily occupied for the shelter and sleeping accommodation of individuals on a day-to-day or week-to-week basis.

Occupancy Group B (previous known as E) (e.g. office buildings) buildings and spaces must be classified in the business occupancy group when they are occupied for transacting business; for rendering professional services; or for performing other commercial services that may incidentally involve the storage of limited quantities of stocks or goods for office use. Buildings and spaces used for prosecuting public or civic services must also be classified in this group.



### 5.2.3 Fire Command Center

Fire Command Center is the principal attended or unattended location where the status of the detection, alarm communications and control systems is displayed, and from which the system(s) can be manually controlled. The Fire Command Center location must be in the lobby of the building on the main entrance floor near the Fire Department designated response point or other location approved by the FDNY. The Fire Command Center may be located in the



lobby of the building on the entrance floor as part of elevator control panel or immediately adjacent to it. It can be as simple as a fire alarm control panel used to monitor

different signals related to fire alarm systems and to make announcements through the communication system. It may also include elevator recall, ventilation shutdown, activation of the release of all fail-safe (electro-magnetic door release) devices (if applicable), activation of stair pressurization and smoke ventilation systems, etc.

### 5.2.4 Fire alarm control panel (FACP) and signals

#### (1) Fire alarm control panel (FACP)

Fire alarm control panel (FACP) is a system component that monitors inputs and control outputs through various circuits. The primary purpose of the FACP is to process signals received from initiating devices and to activate appropriate signals and outputs. **Only persons holding an FLS Director C of F are allowed to operate and address alarms and signals at the fire alarm control panel during business hours.**



#### (2) Fire alarm signals

A signal initiated by a fire alarm initiating device such as a manual fire alarm pull

station, smoke detector, water-flow switch, or other device in which activation is indicative of the presence of a fire or smoke condition.

When a fire alarm signal is generated, the FACP activates the building audible and visual devices connected to the fire alarm (i.e. horn/strobes), sends a signal to an FDNY approved central station, and actuates control of certain building functions. When they receive fire alarm signals, operators at the central station call the FDNY dispatch and re-transmit the information during the conversation with the Fire Department.

The operator must also notify the premises after calling the Fire Department. Alarm signals transmitted to the

Fire Department must indicate the type of alarm received (e.g., automatic, valve, manual, or carbon monoxide).

If a fire alarm signal is generated, the FLS Director must treat it as a fire/smoke emergency and perform the required duties and responsibilities (refer to Chapter 11 of this booklet).

(3) **Supervisory signals**

A supervisory signal indicates that a system or device being monitored has been compromised or is in an abnormal state. Supervisory devices are commonly installed as part of some protection systems. The supervisory devices monitor important parts of the system. A supervisory signal will audibly and visually annunciate at the FACP to indicate the supervisory condition which needs to be investigated and corrected. For example, a signal will be sounded when a control valve is closed or in the wrong position. This type of signal is commonly called a supervisory signal. The signal is always transmitted to the FACP.

When a supervisory condition is indicated, the FLS Director should check the system in order to identify the part of the system that caused the signal. Then that part of the system should be identified and dealt with accordingly. If the FLS Director cannot identify the problem or notice any malfunction, the FLS Director must contact the contractor to investigate and fix the problem(s). The supervisory signal will be transmitted to an FDNY approved central station as well.

Some FACP's indicate the exact location of the problem. Other FACP's only display a general supervisory signal. For example, an older FACP might only indicate the type of the device but not necessarily the exact location of the problematic device. Each supervised device must then be inspected to determine which part is causing the signal.

Supervisory signals are generated from supervisory devices such as:

1. Control valves - i.e. sprinkler system tamper switches (supervised for off-normal conditions).
2. Low air pressure switch - supervised for air pressure in dry pipe sprinkler/standpipe system.
3. High/Low water level switch on a gravity tank - supervised for high/low water and temperature.
4. Electric fire pumps - supervised for pump running, pump failure, and phase reversal.
5. Air pressure in the pressure tank.

**Note: The FDNY is not dispatched to respond to supervisory signals. Supervisory signals are not indicative of a fire condition.**



Pressure Supervisory Switch



Tank Water Level Supervisory Switch



Temperature Supervisory Switch



Tamper switch on a sprinkler valve

#### (4) **Trouble signals**

Fire Alarm Control Panels (FACP) are provided with means to detect and signal trouble conditions. Trouble signals indicate that the alarm system, transmitter, or communications path is wholly or partially out of service. Common trouble conditions monitored by an FACP are battery condition, AC failure, ground fault, open or short circuit on a wire, phone line failure, or internal component failure.

Upon receipt of trouble signals or other signals pertaining solely to equipment maintenance of an alarm system, the central station will communicate with persons designated by the subscriber (e.g. FLS Director).

A trouble signal will ordinarily annunciate audibly and visually at the FACP to indicate the trouble condition, which needs to be investigated and corrected.

**Note: The FDNY is not dispatched to respond to trouble signals. Trouble signals are not indicative of a fire condition.**

If a trouble signal is generated, the FLS Director must investigate and ensure the situation has been corrected.

The FLS Director should contact the contractor to fix the problem(s).

#### **5.2.5 Central Station Transmitter**

A central station transmitter is a device that receives alarm signals from protected premises and retransmits those signals to the Fire Department's Bureau of Fire Communication through an FDNY approved central station. The FLS Director should be familiar with the location of the central station transmitter box.

#### *5.2.6 In the case any fire alarm, supervisory or trouble signal is generated*

##### (1) **Acknowledge switch or button**

An acknowledge button (also abbreviated as ACK) is used to acknowledge alarm, trouble, or supervisory conditions. The sequence and procedures may differ in every fire alarm system; however, it is important for the FLS Director, when present and practical, to report to the FACP location whenever the alarm is activated.

Pressing acknowledge may identify the device or zone in alarm, if not already identified on the FACP.

(2) **Alarm silence switch or button**

The alarm silence switch is used to silence the building audible and visual devices (such as sirens, bells or gongs) after an evacuation is complete while the source of alarm is being investigated. **Never silence or reset the fire alarm system until the condition is verified by FDNY firefighting personnel.** Depending on the configuration of the alarm system, this function will either silence the system's notification appliances completely or will silence only the audible alarm, with strobe lights continuing to flash. However, the silence switch does not prevent a signal from being transmitted to an FDNY approved central station. Audible silence allows for easier communication for emergency responders while responding to an alarm.

(3) **System reset switch or button**

This switch is used to reset the fire alarm system after an alarm condition has been cleared. All initiating devices should return to normal condition after being manually reset. If an initiating device is still in alarm after the system is reset, such as smoke detectors continuing to sense smoke or a manual pull station still in an activated position, another alarm will be generated. Most trouble and supervisory conditions will clear automatically when conditions are returned to normal. After a fire alarm is reset, the fan usually requires restarting from a separate "fan restart" button or key switch.

An FACP indicating an alarm signal cannot be reset to "normal" if the device or devices signaling the alarm to the FACP have not returned to "normal" from "alarm".

**DO NOT SILENCE BUILDING AUDIBLE VISUAL DEVICE OR RESET THE FIRE ALARM PANEL UNTIL THE FIRE ALARM CONDITION HAS BEEN VERIFIED BY THE FDNY FIREFIGHTING PERSONNEL.**

**5.2.7 Initiating devices**

An automatic fire alarm system is a system which sounds a signal when a fire detection device indicates that there is a fire.

An automatic fire detector is an initiating device which detects the presence of a fire condition and initiates action. This includes the detection of the presence of smoke and or heat. Initiating devices will activate the fire alarm system.

As stated in the NYC Fire Code, the term "initiating" device covers not only fire detection devices such as heat detectors and smoke detectors, but also other devices that monitor conditions related to fire safety.

**Proper preventative measures must be taken to protect all fire alarm initiating devices i.e. smoke, heat, and duct detectors especially during construction.**

(1) **Smoke detectors**

A smoke detector is a device that detects visible or invisible particles of combustion. Smoke detectors have been shown to be very effective in reducing fire damage and loss of life.



Smoke detectors detect most fires much more rapidly than heat detectors. They automatically detect a fire by sensing smoke particles. The smoke particles may be visible or invisible to the human eye.

Smoke detectors are fragile devices. Where smoke detectors are subject to mechanical damage, they must be protected. A protective guard used to protect a smoke detector must be listed for use with that detector (example pictured on the right) (NFPA 72). When a smoke detector reports the need for maintenance to the fire alarm control panel, it must be cleaned within 1 week.



**Smoke detectors are helpful in two very important ways:**

1. Smoke detectors can provide an early warning of a fire.
2. The early warning allows FLS staff and building occupants to immediately implement the proper emergency procedures.

There are several kinds of smoke detectors. Most smoke detectors work either by optical detection (photoelectric) or by physical process (ionization) while multi-sensor detectors use both detection methods to increase sensitivity to smoke. Modern smoke detectors also may have a heat sensor built in.

There are different combination sensing technology smoke detectors installed inside high-rise buildings. Some combination smoke detectors may activate other building systems:

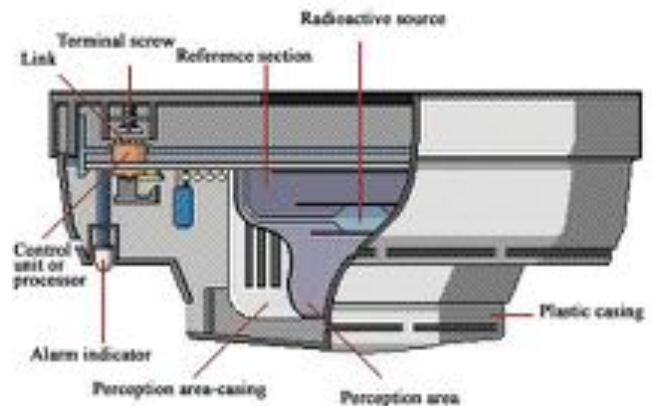

- **Elevator lobby smoke detectors** are smoke detectors that when activated will recall elevators automatically to the designated landing.
- **Duct smoke detectors** are used to help prevent smoke from spreading from the fire area to other parts of the building by shutting down the HVAC system. They also may be used to help protect the air handling equipment by shutting down the system if the fan or filter should start burning. When used with smoke control systems to redirect the airflows in the building, they control smoke dampers in the ductwork, thus changing the direction of airflow, instead of shutting down the HVAC units.



**Duct Smoke  
Detector**

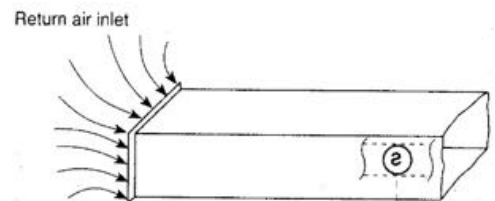

Detectors placed in environmental air ducts or plenums must not be used as a substitute for open area detectors. Air duct smoke detectors work by detecting smoke and control air movement by air conditioning and ventilating systems (pictured on the right).



**It is imperative that air movement be shut down in the event of a fire.** Fire alarm systems are therefore interfaced to HVAC systems so that an alarm signal from the fire alarm system will cause the air handling systems in the area of the alarm to shut down.

(2) **Heat detectors**

A heat detector is a device that detects abnormally high temperatures or rate of temperature rise. Heat detectors have been shown to be very effective in reducing fire damage. An illustration of a heat detector is shown below:

Heat detectors are available in two general types: **rate-of-rise and fixed temperature.**

Heat detectors can only be tested by authorized fire alarm technicians. C of F holders are responsible for ensuring that operational heat detectors are in place. They must notify fire alarm maintenance companies to make all necessary repairs.

a. **Rate-of-rise heat detectors** activate the alarm when the room temperature increases at a rapid rate. This type of detector is more sensitive than the fixed temperature detector. The rate-of-rise heat detector **does not** have to be replaced after it has activated the fire alarm. All heat detectors must be carefully installed according to the manufacturer's instructions.



**Rate-of-rise heat detectors**

b. **Fixed-temperature heat detectors** activate the alarm when the detector components melt at a preset temperature level. The fixed-temperature heat detectors normally require replacement after they have sounded an alarm. However, intelligent heat detectors will usually reset themselves. For further information, contact your fire alarm service provider.

The fixed-temperature heat detectors are most commonly used. The detectors consist of two electrical contacts housed in a protective unit. The contacts are separated by a fusible element. The element melts when the temperature in the room reaches a preset level. This allows the contacts to touch. When the contacts meet, the detector activates the fire alarm.



**Fixed-temperature heat detectors**

Where subject to mechanical damage, a heat detector must be protected by an approved UL/FM mechanical guard as shown in the picture below.



**Heat detector with protective mechanical guard**

**(3) Sprinkler waterflow alarm-initiating devices**

The waterflow alarm initiating devices are used to detect the flow of water in a fire sprinkler system and to send an alarm signal. If the water starts to flow in the system, the vane or paddle triggers a switch sending a signal to the fire alarm control panel and activate bell. This device does not turn on or off the water. The activation of these devices will cause the fire alarm system to sound, recall the elevators and will send the fire alarm signal to the central station if the fire alarm system is monitored.

**Water-flow Switch**



**(4) Manually actuated alarm-initiating devices**

Fire alarm systems that are manually activated use fire alarm pull stations. Manual fire alarm boxes (also referred to as pull stations) must be located near the exits throughout the protected area so that they are conspicuous, unobstructed, and accessible.

They must be located on each floor of a building.



Once a manual pull station is activated, that device must be reset prior to resetting at the main fire alarm control panel (FACP). **The FACP must only be reset at the direction of a Fire Department representative.**

The manual pull stations may exist that have a white stripe across them (as the

left picture indicated). Prior to 2008 a manual pull station with a white stripe across it would indicate that such station will send a signal to the central monitoring company. However, since 2008, the requirement of such stripe no longer exists.



**The manual pull stations may not directly transmit a signal to the FDNY. A phone call must always be made to 911 or the FDNY dispatcher. DO NOT assume that the FDNY has been called if you hear a fire alarm or smoke detector sound.**

The FLS Director and the FLS staff must know how to manually operate each alarm station on the premises. Once activated, the fire alarm system cannot be re-set at the fire alarm manual pull station. The alarm must be re-set at a main FACP after the pull station is reset to its normal condition; a key may be required to reset the manual pull station. The alarm may be turned off only by an FLS Director or by a Fire Department representative.

In most buildings, the activation of manual pull stations does not: (1) recall elevators; (2) release fail-safe devices, or (3) shut down HVAC system.

- **Single action stations** require only one step to activate the alarm. For example, the alarm might be activated by pulling down on a lever. An example of a single action station is shown on the next page. This kind of alarm station is often found indoors, e.g., in office buildings. The cover on these alarm stations serves as a lever. When the cover is pulled down, it allows a switch inside to close. This sends the alarm signal.



- **Double action stations** require two steps in order to activate the alarm. The user must first break a glass, open a door, or lift a cover. The user can then gain access to a switch or lever which must then be operated to initiate an alarm. To activate this type of alarm station, the cover must be lifted before the lever is pulled. This kind of double action station is often found indoors. Another kind of double action break glass station requires someone to break a small pane of glass with a small metal mallet.





**Double action station**

The FDNY may require the approved protective covers to be installed over single or double action stations to prevent malicious false alarms or provide the manual fire alarm box with protection from physical damage.



(5) Carbon monoxide detectors

Carbon monoxide detectors are required in any building that has fossil (gas and oil) fuel burning equipment.

A carbon monoxide detector is a device indicating a concentration of carbon monoxide at or above the alarm threshold that could pose a risk to the life safety of the occupants and that requires immediate action. Carbon monoxide detectors must be installed, tested, and maintained by qualified personnel in accordance with the manufacturer's published instructions.

**Carbon monoxide detector**



If a carbon monoxide detector is in alarm condition and cannot be reset, this could indicate that carbon monoxide is still in the premises. Until such time that carbon monoxide can be excluded as the source of the alarm, the assumption should be that carbon monoxide is present, and appropriate life safety precautions should be followed.

Signals from carbon monoxide detectors transmitted to a fire alarm system might be programmed as supervisory signals. However, if the carbon monoxide detectors are installed in a public areas, the signal will be programmed as a fire alarm signal and be transmitted to the Fire Department.

**(6) Flammable/combustible gas detectors**

Although it is not required by the FDNY, some flammable/combustible gas detectors (e.g. natural gas detector) may be connected to the Fire Alarm Control Panel. The FLS Director must know if the flammable/combustible gas detectors on the premises are connected to a stand-alone monitor panel or the Fire Alarm Control Panel. If the detectors are connected to the Fire Alarm Control Panel, the activation will generate a supervisory signal on the Fire Alarm Control Panel and also be transmitted to the Central Station. Since it is not programmed as a fire alarm signal, there is no alarm tone sounded on the premises to notify the public. However, the Central Station will still notify the premises owner and the Fire Department for flammable/combustible gas detectors' activation since flammable/combustible gas leakage may cause a fire, explosion or life-threatening condition.

Flammable/combustible gas leak may be considered as a non-fire emergency incident, as an FLS Director, if you are aware of this incident, you will need to follow the FDNY plan to perform the required actions before the FDNY arrives. Once the FDNY firefighting personnel is dispatched to the premises to investigate the situation, the building staff and occupants must comply with the orders of FDNY firefighting personnel.



Example of a flammable/combustible gas detector

**(7) Building fire protection features - activated by the automatic initiating devices of the fire alarm systems**

1. Smoke dampers (where connected to FACP): Smoke dampers open and close when required to provide fresh air or to stop smoke passage.
2. Elevator recall: The fire alarm system integrates with elevator controls to recall elevator cars to a designated landing floor in the event of an alarm. In this case, the activation of any automatic fire detection system will initiate the Phase I mode.
3. Fire door release (where connected to FACP): Any fire door must be in a closed position to serve as a protective barrier in the event of a fire. If - doors are held open by electromagnetic release devices, the devices will be activated by the automatic initiating devices so those doors will automatically close to provide a smoke barrier between two areas.
4. Exit door release (where connected to FACP): Exit route doors must be unlocked from the inside. They will be free of devices or alarms that could restrict use of the exit route.
5. Stairway fail-safe door release (where connected to FACP): Some automatic initiating devices (e.g.

sprinkler waterflow device) will activate the fail-safe door system. It will allow the stairway doors equipped with this system to be unlocked from the stair side.

6. HVAC system will automatically shut down (where integrated with the fire alarm system): Some automatic initiating devices (e.g. duct smoke detector) will shut down the HVAC system when they are activated. The FLS Director must consult with the building engineer to know how the HVAC system will be affected during a fire/smoke incident.

***(8) Types of devices, and activations***

TYPE OF DEVICE	ACTIVATED BY	ACTION NORMALLY REQUIRED TO RETURN DEVICE TO “NORMAL” CONDITION
Manual pull station	Manually pulling handle	Return handle to normal position. A key or other method may be required to reset the station to a normal condition.
Smoke, beam, and duct detectors	Detection of particles of combustion <b>*see note below</b>	Smoke detectors will normally reset when the reset button is pressed at the FACP if the condition activating the detector has been cleared.
Heat detectors	Abnormally high temperature (fixed temperature detector) or rapid temperature rise (rate of rise detector)	After activation most <b>fixed temperature</b> heat detectors will not self-restore and will require replacement by a qualified service technician. <b>Rate-of-rise</b> detectors will normally self-restore after activation.
Water-flow device	Flow of water in a sprinkler system	Device should return to normal when water ceases to flow.

**NOTE:** There are other circumstances which will cause a smoke detector to signal an alarm condition when there is none, creating false alarms and causing unnecessary Fire Department responses. Care must be taken at all times to protect all smoke detectors from the entrance of foreign particles which may be airborne. Dust from cutting wood, sheet rock or sanding may trigger a false alarm. Smoke detectors which have not been properly cleaned and maintained will also create false alarms.

***5.2.8 Power supplies for the fire alarm system***

Most buildings with fire alarm systems are required to have primary and secondary power supplies. **The FLS Director must know the power supply source of the building fire alarm system.**

***5.2.9 Audible and visual notification devices***

Notification appliances are used to alert persons of the need to take action, usually to evacuate. The appliances include bells, horns, speakers, strobes, text displays or a combination of these devices. The audible and/or visual notification alerts the occupants of a fire or other emergency condition requiring action.

## HORNS, HORN/STROBES



Speaker

Speaker strobe

Horn Strobe

Strobe

Gongs Bells

### **5.2.10 Activation of audible/visual notification devices**

The audible or visual notification may be activated by different methods to notify the occupants of a building in case of a fire. Some systems are designed to activate all audible/visual devices throughout the building when a fire is detected. In certain locations, such as a day care center, this may be the only feature available. However, some systems are designed to activate the audible/visual devices only on the floor of alarm, the floor immediately above, and/or the floor below (if applicable).

**As an FLS Director, you must know whether your fire alarm system is designed to ring only on the fire floor, floor above and/or floor below, or throughout the building.**

After the fire alarm system has been activated it must be reset manually. The fire alarm system must be reset at the fire alarm control panel under the direction of FDNY representatives. The fire alarm must remain in operating condition at all times.

### **5.2.11 Communication systems**

#### **(1) Emergency voice/alarm communication systems**

Many buildings have installed emergency communication systems based upon building code and fire code requirements. Emergency communications systems are the systems for the protection of life by indicating the existence of an emergency situation and communicating information necessary to facilitate appropriate responses and actions.

The current NYC Building Code requires that the operation of any automatic fire detector, sprinkler waterflow device, or manual fire alarm box must automatically sound an alert tone to be followed by voice instructions giving approved information and directions for a general or staged evacuation in accordance with the building's FDNY plans.

In high-rise buildings, the system must operate **on a minimum of the alarming floor, the floor above, and the floor below**. Speakers must be provided throughout the building by paging zones. At a minimum, paging zones must be provided as follows:

1. Each exit stairway.
2. Each floor.
3. Refuge areas (a floor area to which egress is made through a horizontal exit).

The emergency voice/alarm communication system must have multi-channel capability. It must be designed to broadcast live voice messages by paging zones on a selective and all-call basis without automatic interruption of the alarm tones on the affected floors.

(2) **Two-way emergency communications systems**

Two-way emergency communications systems are used to exchange information and to communicate information such as, but not limited to, instructions, acknowledgement of receipt of messages, condition of local environment, and condition of persons, and to give assurance that help is on the way.

Two-way emergency communications systems are divided into two categories: (1) systems that are anticipated to be used by building occupants and (2) systems that are to be used by fire fighters, police, and other emergency services personnel.

(a) **Two-way emergency communications systems used by building occupants**

Current NYC Building Code requires that a two-way voice communication system (warden) phone that complies with the requirements of NFPA 72 must be provided in the following locations and must comply with the following requirements.

Such phones must communicate with the Fire Command Center.

The warden phones are usually located near exit stairways in the building. A warden phone must also be installed in the FACP. The FACP is used to issue instructions during a fire or non-fire emergency.

- a. In Group B high-rise and large area office buildings, there must be at least one warden phone located on every floor accessible to all occupants.
- b. Where elevator lobbies are permitted to be locked, the phones provided are permitted to be connected to the fire alarm system.
- c. If phones are provided in areas of rescue assistance and refuge areas, the phones are permitted to be connected to the fire alarm system.
- d. Where phones are provided to meet the requirements for stairway communication systems, the phones are permitted to be connected to the fire alarm system.

Exception: Group R-2 occupancies.

The two-way emergency communications system is displayed and can be manually controlled at the Fire Command Center. The Fire Command Center is a communications center

supervised by a central station and, located in the lobby of the building on the entrance floor. It normally provides individual two-way voice communication from the Fire Command Center to a fire warden station on each floor and to the regularly assigned location of the FLS Director, to consist of a telephone handset, approved speaker microphone system or other approved voice communication system. Although it is a two-way voice communication device, only fire warden phones can initiate the communication to the Fire Command Center, the Fire Command Center cannot initiate the communication to any fire warden phone. If the FLS Director needs to initiate the communication with specific floor warden(s), the FLS Director should make a localized (or all call) announcement requesting the floor warden(s) reporting to the warden phone. The floor warden(s) must immediately report to the warden phone and initiate the communication with the Fire Command Center.



### **(b) Two-way emergency communications systems used by fire fighters - ARC system**

As of December 31, 2014, the New York City Building Code requires that an in-building auxiliary radio communication (ARC) system be installed and maintained in all newly constructed high-rise buildings. An ARC system is a wireless two-way building communication system for Fire Department use only that receives and transmits Fire Department portable radio frequencies within the building. An ARC system typically consists of a transceiver (base station) connected to a building-wide antenna system, with a radio console in the building lobby. Operation of the ARC system, other than by Fire Department personnel, including inspection and testing, must be under the personal supervision of a person holding a B-03 C of F who is employed by an approved company. The company list is updated on a monthly basis and can be accessed through the following link: <http://www1.nyc.gov/assets/fdny/downloads/pdf/business/approved-companies-arc-system.pdf>

The FDNY must be notified immediately if an in-building auxiliary radio communication system for fire department use, or part thereof, is out of service. A tag identifying the system as out of service must be placed on the Fire Command Center or other approved location when the ARC system is out of service.

### **(3) One-way emergency communications systems (other than voice/alarm communication systems)**

One-way emergency communications systems are intended to broadcast information, in an emergency, to people in one or more specified indoor or outdoor areas. It is intended that emergency messages (e.g. evacuation instructions) be conveyed either by audible, visible, or textual means, or any combination thereof.

#### **5.2.12 Periodic inspection and testing requirements**

Fire alarm systems are required to be maintained in good working order. To ensure that fire alarm systems are maintained in such condition, the Fire Code and Rules provide minimum requirements for the periodic inspection, testing, and other maintenance of such systems.

NFPA Standard 72 sets forth detailed requirements for the periodic inspection, testing and other maintenance of fire alarm systems.

**Mandatory visual inspection** frequency requirements for common equipment:

- (1) **Control equipment:** fire alarm system UNMONITORED for alarm, supervisory, and trouble signals: weekly.
- (2) **Control equipment:** fire alarm system MONITORED for alarm, supervisory, and trouble signals:  
annually.
- (3) **Manual fire alarm boxes, heat detectors, smoke detectors:** semiannually.
- (4) In-building fire emergency voice/alarm **communications equipment:** semiannually

**\*\*Daily visual inspection of the Fire Command Center has been the industrial practice and highly recommended by the Fire Department.** The fire alarm control panel and fire alarm devices (such as fuses, interfaced equipment, lamps and LEDs, and Primary (main) power supply, etc.) should be visually inspected for indicated abnormal conditions by the FLS Director. The purpose of the visual inspection is to detect defective components or abnormalities. The visual inspection shall be made to ensure that there are no changes that affect equipment performance.

Testing frequency requirements for common equipment:

- (1) Control equipment: fire alarm system NOT connected to a supervising station: quarterly.
- (2) Control equipment: fire alarm system connected to a supervising station: annually.
- (3) Manual fire alarm boxes, heat detectors: annually.
- (4) In-building fire emergency voice/alarm communications equipment: annually.
- (5) Smoke detectors:

All smoke detectors connected to a defined fire alarm system must be

- a. cleaned at least once every 6 months, except for analog (intelligent) smoke detectors, which must be cleaned no later than one week from receipt of an indication of the need for cleaning.
- b. tested for smoke entry at least once a year.
- c. tested for sensitivity at least once a year, except for analog (intelligent) smoke detectors, which must be tested for sensitivity no later than one week from receipt of an indication of the need for such testing.

The FLSD Computer Based exam will test if the FLS Director candidates know how to refer the frequency chart (refer to appendix A of this booklet) for the inspection, maintenance, and test requirements.

**5.2.13 Companies and individual certifications**

It is the buildings owner’s responsibility to ensure that the buildings fire alarm system is maintained in good working order and to be aware of the Fire Code and Rule requirements, including the operations, inspection, tests and other maintenance of the system. Different Certificate of Fitness holders are permitted to carry different levels of responsibilities in inspecting, testing and maintaining the fire alarm systems:

**(1) Fire Alarm System**

Duties and responsibilities		May be performed by	
		F-89/T-89 /F-80/S-95	S-97/S-98
1.	Visual inspections of fire alarm system	Yes	Yes
2.	Maintain the fire alarm log book	Yes	Yes
3.	Program, service, clean, test, repair, and/or replace any fire alarm system components	No	Yes

Any programming, servicing, testing, repairing, and/or replacing of the fire alarm system components (including test of manual fire alarm stations) must be conducted only by an S-97/S-98 Certificate of Fitness holder. The S97/S-98 C of F holders could work citywide but must be employed by an FDNY Certified Central Station or an FDNY Certified Smoke Detector Company.

- The approved smoke detector maintenance company list is updated on a monthly basis and can be accessed through the following link:



<http://www1.nyc.gov/assets/fdny/downloads/pdf/business/approved-companies-smoke-detectors.pdf>

- The approved central station list is updated on a monthly basis and can be accessed through the following link:

<http://www1.nyc.gov/assets/fdny/downloads/pdf/business/approved-companies-central-station.pdf>

**(2) *Smoke detector cleaning and testing***

Duties and responsibilities		May be performed by		
		S-95/F-89/T-89/F-80	S-78/ F-78	S-97/S-98
1.	Smoke detector visual inspection	Yes	Yes	Yes
2.	Smoke detector inspection, maintenance testing & cleaning	No	Yes	Yes
3.	Program, service, clean, test, repair and/or replace fire alarm components	No	No	Yes

The S-78 C of F holders are allowed to work citywide but must be employed by an FDNY Certified Company. The F-78 C of F holders can be employed by the premises with the necessary tools, instruments, or other equipment to clean and test the smoke detectors.

- The approved smoke detector maintenance company list is updated on a monthly basis and can be accessed through the following link:  
<http://www1.nyc.gov/assets/fdny/downloads/pdf/business/approved-companies-smoke-detectors.pdf>

**(3) *Companies that monitor fire alarm systems***

A central station must be responsible for monitoring and retransmitting the fire alarm system signals. The central station must be certified by the FDNY.

- The approved central station list is updated on a monthly basis and can be accessed through the following link:

<http://www1.nyc.gov/assets/fdny/downloads/pdf/business/approved-companies-central-station.pdf>

**5.2.14 Unnecessary and unwarranted alarms**

Unnecessary and unwarranted alarms directly impact fire and life safety in many ways, such as diverting essential services from emergencies or posing an unnecessary risk to first responders, etc. They also cause business disruptions leading to a loss of productivity and create public's negative views of fire alarm systems. The owner of any premises whose fire alarm system automatically transmits signals to the Fire Department or to a central station is responsible for preventing unnecessary and unwarranted alarms. It is unlawful to transmit 2 or more unnecessary or unwarranted alarms in any three-month period and will be subject to issuance of a **Fire Department Summons** (previously known as Notice of Violation).



## 5.3 Standpipe systems

### 5.3.1 Introduction

A standpipe system is piping installed in a building that serves to transfer water to hose connections located within the building for firefighting purposes. Whether a building must be provided with standpipe system or not is generally set forth in the NYC Building Code: for example standpipe systems are required in buildings that are more than 75 feet in height. Standpipe systems are installed in buildings to help firefighting personnel deploy attack hose lines quickly and with adequate water pressure and volume to fight a fire. Standpipe systems consist of a network of fixed piping and hose valve connections. Water is supplied either through a gravity tank, city main, or manually through an FDNY connection. Standpipe systems provide a reliable water source to extinguish or control an interior fire in the building.

The piping of the standpipe system runs vertically (up and down) and horizontally (side to side) throughout the building. The piping running vertically is usually called risers. The risers are usually located in the staircase enclosures or in the hallways in the building. This piping system supplies water to every floor in the building. When a standpipe system is installed and properly maintained, it is a very effective means for extinguishing fires. A typical standpipe system is shown below in the illustration below:

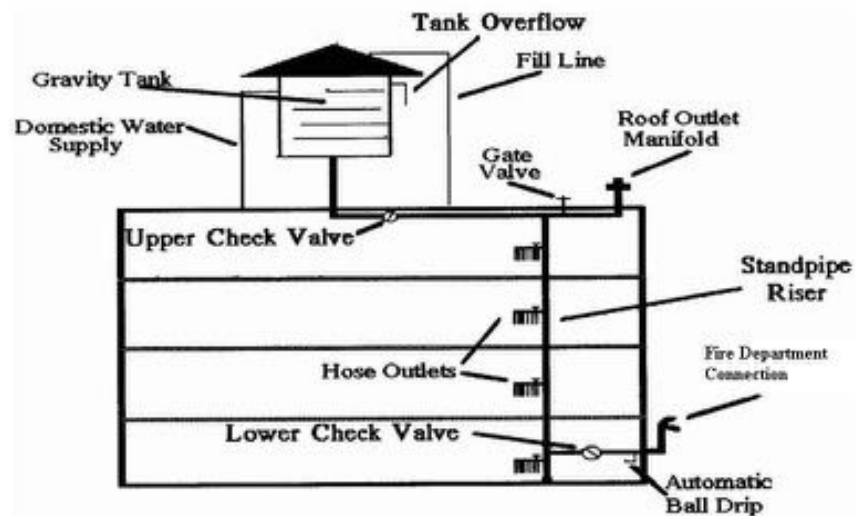

### 5.3.2 Standpipe system types

#### (1) Wet standpipe system

This system always has water in the piping. The water in the system is always under pressure. In some cases, a fire pump may be used to increase the water pressure. **The wet standpipe system is the most commonly used system.** It is used in heated buildings where there is no danger of the water in the piping freezing. Any part of the standpipe system that is exposed to freezing temperatures should be insulated. It is very important that the water in the piping does not freeze. Frozen water may prevent the standpipe system from working.

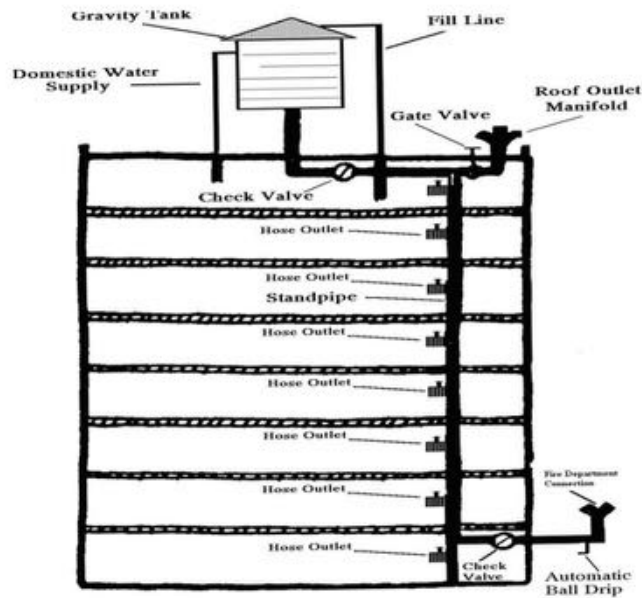

### Wet Standpipe System

(2) **Dry standpipe with an automatic dry pipe valve (Manual standpipe) (commonly found in construction sites)**

Dry standpipe system is usually installed outdoors, in some premises without heating during cold weather or in some non-heated areas inside a building (e.g. garage, loading docks). This dry standpipe system with an automatic dry pipe valve is usually supplied by a public water main. Under normal conditions there is no water in the piping. Instead, there is air under pressure in the piping. A dry pipe valve is installed to prevent water from entering the standpipe system. The dry pipe valve clapper is designed to open when there is drop of air pressure in the standpipe. When a hose outlet valve is opened it causes a drop in air pressure in the standpipe system. Then the dry pipe valve automatically lets water flow into the standpipe. A control valve is installed at the automatic water supply connection. This valve should be kept open at all times to supply the standpipe system. This system is usually installed in a building that is not heated. The air pressure is usually set at 15 to 20 psi (pounds per square inch) above the normal trip level. Some valves are specially designed for low pressures. In all cases, the manufacturer's instructions regarding pressures to be maintained must be followed.

If a drop of pressure in the piping has caused the clapper to open, it is said to have tripped. Quick opening devices (e.g. accelerator, exhaustor) are used to reduce the time needed to open the clapper and allow water into the system. The failure of any quick opening device to operate will increase the normal tripping of a dry pipe valve.

(3) **Multi-zone systems**

Multi-zone system is a standpipe system that is vertically subdivided as required by the construction codes into zones to limit the maximum operating pressure in the system. Each zone will have its own individual automatic water supply. Standpipe zone heights are limited to 300 feet. All zones serving occupied floors located higher than 300 ft. shall be provided with primary and auxiliary water supplies. For example, a 50-story building may have a low zone ranging from the first floor to the 25th floor. A fire pump on the first floor supplies floors 1 to

25; a fire pump on the 25th floor supplies water from the 26th floor to the roof. Each zone may have its own Fire

Department Connections (FDCs). The design of the multi-zone systems varies from building to building. The FLS Director and the S-14 Certificate of Fitness holder must be familiar with the system design and must be immediately available to assist the Fire Department in the operation of the system in the event of a fire.



(The left FDC in the photo is to cover the lower zone and the right FDC is to cover the higher zone)

#### **(4) Combination standpipe and sprinkler systems**

It is common to find occupancies having a combination of systems for fire protection. A Combined Sprinkler/Standpipe System incorporates a water supply for automatic sprinklers with a standpipe system. The standpipe and the sprinkler systems may share the same water supply and riser piping. The FLS Director must know the water supply for the systems and the location of each riser used by the standpipe and sprinkler systems.

The FLS Director must also know the location of all control valves for different systems.

#### **5.3.3 Water supplies to the standpipe systems**

Standpipe systems may be supplied from one or a combination of sources. For example, they may be supplied by city mains, gravity tanks, pressure tanks, etc. **The FLS Director must know what is/are the water supply (supplies) for the building standpipe systems.**

The primary and secondary water supply for a standpipe system may be:

- City mains
- Automatic fire pumps (used with water main when the pressure is inadequate)
- Gravity tanks
- Pressure tanks
- Manually controlled fire pumps with pressure tanks
- Suction tanks
- Fire Department Connection which is supplied by the FDNY (secondary water supply source)
-

***(1) City mains and automatic fire pumps***

The city main (public water system) is the most commonly used water supply source. A connection is installed to a reliable public water works system check valve is also installed next to the connection. The purpose of the check valve is to make sure that the standpipe system does not backflow into the public water system. In tall buildings, the connection to the city main may not provide enough water pressure to supply the upper floors. In such buildings, city main is not used as the primary water supply source, but fire pump or gravity tanks are usually installed. An automatic fire pump can help to maintain the desired water pressure levels.

***(2) Gravity Tanks***

A gravity tank can provide the water without the use of a pump. All the energy for the system is available from the height of the gravity tank (the force of gravity). Gravity tanks are used for water storage. They are made of wood, steel, or concrete. Gravity tanks are used as a primary or secondary water supply source for standpipe systems. A gravity tank delivers water to the standpipe system without the use of pumping equipment. Gravity Tanks may be located on the tops of buildings or raised on tall supporting towers. A gravity feed standpipe system distributes water throughout the fire protection piping without the use of pumping equipment.

The water pressure in a gravity tank system depends on the elevation of the tank. This is a major advantage over other kinds of systems. Automatic fill pumps supply the water to most gravity tanks. The fill pumps of the gravity tanks are normally low flow rate pumps. It cannot supply enough water to fill up the tank quickly during the fire. Two floats control the amount of water in the tank. The floats turn on the fill pump when the water in the tank is too low. The floats shut off the pump when the desired water level is reached.

The floats make sure the gravity tank always has the right amount of water to supply the standpipe system. All gravity tanks have an overflow pipe that drains off too much water in the tank. This happens if the floats do not turn off the fill pump. A fill pump is not necessary if the water pressure in the city water main is able to keep the tank filled with the right amount of water.

Gravity tanks are exposed to very low temperatures. All parts of the gravity tank must be insulated or heated to keep the water from freezing. Several methods are used to heat the tank and the pipe that supplies the water. (1) Hot water is circulated by gravity. (2) Steam is discharged directly into tank. (3) Steam coils are placed inside the tanks. (4) Heat from the sun is used. The FLS Director or S-13/S-14 C of F holder can find out the temperature of the water by looking at a thermometer. The thermometer is located near the heating device. The tank can be severely damaged if the water inside the tank freezes. The temperature of the water should always be at least 40° Fahrenheit. Ice should not be allowed to build up on the gravity tank. The extra weight of the ice can weaken the supports of the tank, and cause the tank to collapse. Falling ice may also cause damage or injury. It is essential to be sure that the tank is properly heated, insulated, and carefully maintained.

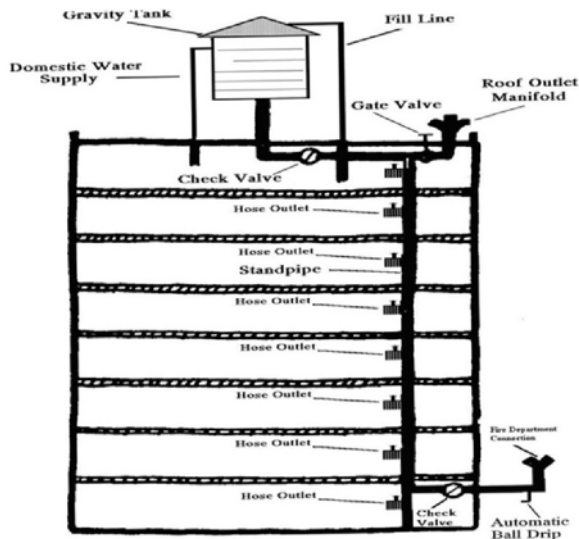

The gravity tank must always have a full supply of water. **A full tank of water is needed to be sure the standpipe system works properly during a fire.** Keeping the tank full of water also prevents wooden tanks from shrinking. A full tank of water also helps to keep steel tanks from rusting.

It is best if gravity tanks are used only for fire protection and for no other purpose. Tanks used for other purposes need to be refilled more often. The tanks become settling basins for sediment mixed in with the water. This sediment is then drawn into the piping. This may cause the standpipe system to become clogged and not work properly. The Borough Dispatcher should always be notified when a tank cannot be used for any reason.

Failure of a standpipe system supplied by a gravity tank during a fire is usually caused by not enough water in the tank. The standpipe system cannot be supplied if there is not enough water in the tank. Too much water in the tank can also cause the fire protection system to fail. Too much water in the tank may cause damage due to the weight of the extra water. This could cause the gravity tank to collapse.

The gravity tank must be constantly monitored to be sure that the tank and its parts are working. Electrical supervision devices monitor the water temperature and the water level in the gravity tank. These devices send signals to a central station about the water level and water temperature. A supervisory signal will also ordinarily annunciate audibly and visually at the fire alarm control panel to indicate the supervisory condition needed to be investigated and corrected. The supervisory devices are sometimes called high and low alarms since they also send audible signals to alert the FLS Director when there is a problem. The FLS Director should contact a contractor with S-13 C of F to correct the problem as soon as possible.

### **(3) Combination gravity tank and pressure tank installation**

Pressure tanks may be used in combination with gravity tanks to supply a standpipe system. Both tanks may be used to make sure that an adequate water supply is available. The pressure tanks also provide added water pressure to the fire protection system. An example of a combined installation is shown in the picture below:

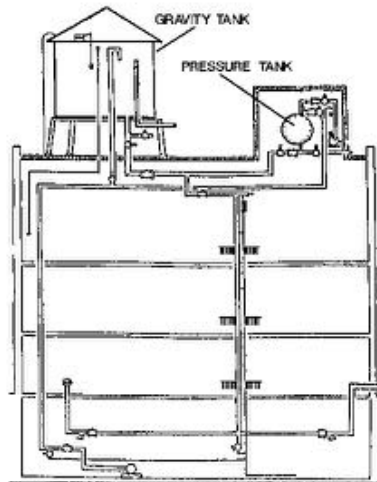

### Combination Gravity Tank and Pressure Tank Installation

#### (4) Suction tanks (rarely found in the New York City)

Suction tank is a tank installed in combination with a pump. The required energy for the system is provided by the pump. Automatic fire pumps may be installed to augment other water supply systems or to provide the entire initial water supply needs of a facility. A suction tank and fire pump(s) in combination are considered one of the water supply sources.

Fire pumps usually take suction from large aboveground suction tanks. These tanks may be filled either manually or automatically from a public water supply, a well, or another water source capable of filling the empty tank within 8 hrs. If the fire pump suction tank is equipped with automatic fill, the suction tank must be sized to hold at least two-thirds of the total water requirement. If the automatic fill source cannot supply the remaining capacity, the suction tank size should be increased.

#### (5) Fire Department Connections

A Fire Department Connection is always installed on the system. The connection is used by the Fire Department to pump water into the system. Fire Department Connections must always be accessible. Each connection must be equipped with a check valve. A secondary source of water supply for standpipe systems includes Fire Department Connections.



For **wet standpipe systems**, the Fire Department can pump supplemental water

through the Fire Department Connections into the standpipe system, or other system furnishing water for the fire extinguishment to supplement existing water supplies.

For **dry standpipe systems**, the Fire Department can pump the primary water supply through the Fire Department Connections to the dry standpipe system at the required system demand.

Fire Department connections must be located on the street side of buildings, fully visible and recognizable from the street or nearest point of Fire Department apparatus access. Immediate access to Fire Department Connections must be maintained at all times, without obstruction by fences, posts, bushes, trees, rubbish containers, vehicles, walls or other objects. If the access to Fire Department Connections is obstructed by a fence, the fence must be approved by the

Building Department and Fire Department and a required signage and a means of emergency operation must be provided. A working space of not less than 36 inches in width, 36 inches in depth and 78 inches in height must be provided and maintained in front of and around wall-mounted and free-standing fire department connections. Where Fire Department Connections are subject to impact by a motor vehicle whose normal operation brings it into proximity with such connections, such as when Fire Department Connections are located curbside or adjacent to loading or parking areas, vehicle impact protection must be provided.

Fire Department Connection should be fitted with a check valve, but not with a gate valve. The check valve prevents the backflow of the private water supply into the public water supply. The figures below show the main features of a Fire Department Connection.

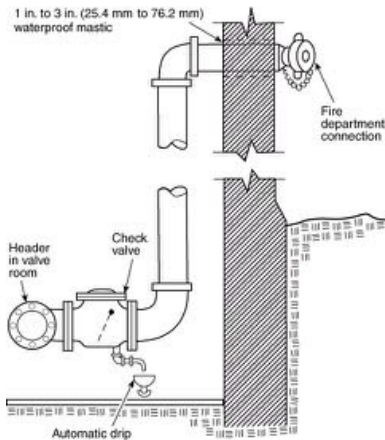

The piping between the check valve and the outside hose coupling on the

Fire Department Connection should remain empty when the Fire Department Connection is not in use. This piping runs along the outside wall of the building and, if there is water in this piping, there will be danger of the water freezing in the pipe. Such freezing could cause the pipe to burst or could block the pipe, preventing the Fire Department from introducing water into the piping through the Fire Department Connection in the event of an emergency. To ensure that this piping between the lower check valve and the outside hose coupling on the Fire Department Connection remains empty when not in use, the

piping is equipped with an automatic ball drip device. This automatic ball drip device drips water to empty the piping between the check valve and the Fire Department Connection. Water dripping from the automatic ball drip device indicates one of two things: either there is water in the piping because a hose was recently connected to the Fire Department Connection, either for an emergency or for 5-year hydrostatic testing; or there is water in the piping because the check valve is faulty and is allowing water to flow into the piping. **Water dripping from an automatic ball drip device if a hose was not recently connected to the Fire Department Connection is an indication of a faulty check valve.**

Fire Department Connections serving a standpipe system must be provided with **caps painted red** and must have the word “**STANDPIPE**” in letters 1 inch (25 mm) high and 1/8 inch (3.2 mm) deep cast in the body or on a non-ferrous metal plate secured to the connections or mounted on the wall in a visible location, except that caps of fire department connections used for combination standpipe and sprinkler systems must be **painted yellow** and the words must read: “**COMBINATION STANDPIPE AND SPRINKLER SYSTEMS.**”





### 5.3.4 Pumps in the standpipe systems

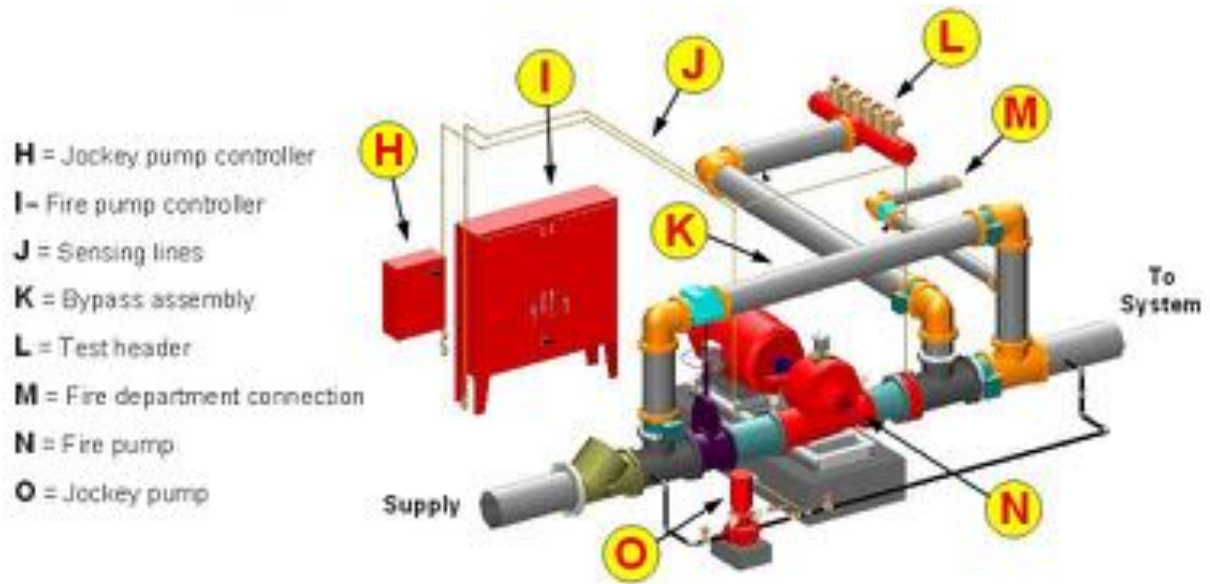

FLS Director must know the location of the fire pumps, jockey pumps, and the activation buttons/switches for manual fire pumps. The FLS Director also needs to know how to identify these devices. This knowledge will assist the Fire Department in the operation of the system in the event of a fire. However, possession of the FLS Director Certificate of Fitness does not authorize you to operate, maintain, service, or perform any repair to the pumps or other related standpipe devices.

#### (1) **Fire pump**

A fire pump can be used as a primary water supply source for a standpipe system. Fire Pump draws water from a suction/gravity tank or city mains and pumps it into the system when needed. Other sources of water supply for multi-zone standpipe system can be fed with gravity and/or pressure tanks to supply the system.

A fire pump is usually connected to a city main which may be consider to be one of the most reliable water supply arrangements. Fire pumps are designed to take the water from a supply source and then discharge the water into the standpipe system under pressure. The pressure with which the water is discharged from the pump is called the total head. The total head is usually measured in PSI. The higher the psi rating of the pump, the greater the pressure with which the water can be discharged.

A fire pump can be started automatically or manually. The FLS Directors must know the fire pump type in their premises and be familiar with the inspection requirements and related devices:

#### (a) **Automatically activated fire pump**

The pump can be started automatically by an electric controller or an engine controller. Controllers activate the pump when there is a drop in water pressure or water flow within the fire protection system.

When fire pumps are activated by electric automatic controllers, it is essential that they are constantly monitored to ensure the availability of the electrical power supply in case of an emergency. For this reason, supervisory devices are installed on the pumps to alert the FLS Director and/or a central station when there is an electrical power failure. In cases where the



steam turbines or internal combustion engines are used, similar supervisory devices are installed to signal when there is a problem with the controlling equipment.

***(b) Manually activated fire pump***

When manually activated pumps are installed, they are used in combination with a city main. When there is a fire or smoke condition in the building, the fire pump must be activated manually. Manually operated fire pumps are often found in industrial and manufacturing occupancies having personnel on the premises at all times.

Remote push buttons/switches are often used to activate the pump. These remote push buttons/switches are designed to start the pump but not to stop the pump.

**Location of fire pump**

The fire pump should be housed in a room that is fire resistant or constructed of noncombustible material. The pump room should be located as close as possible to the fire protection system. The pump room should be kept clean and accessible at all times. The fire pump, driver, and controller should be protected against possible interruption of service. The temperature inside the pump room should be maintained above 40° Fahrenheit at all times to prevent freezing of the water in the system. The pump room should only be used for fire protection functions and not for general plant operations.

The FLS Director must know the location of the fire pump room of the premises.

***(2) Jockey pump***

Jockey pumps, pressure maintenance pumps, are designed to automatically or manually operate when there is a slight drop in pressure due to the leakage within the system or a pressure surge. The jockey pump restores the pressure in the fire protection system to the required level. For example, if a small leak exists in the wet riser piping, the jockey pump will start in order to compensate for the leak. When the drop of pressure within the system is greater than the capacity of the jockey pump, the fire pump is activated.



### 5.3.5 Risers, valves, hoses and painting requirements

#### (1) Risers

Standpipe and Sprinkler Risers are the vertical portion of the system piping that delivers the water supply for hose connections, and sprinklers on standalone as well as combined systems, vertically from floor to floor.

Most buildings have a wet standpipe system where the pipes are kept full of water for manual or automatic fire fighting operations.

Dry risers are used for a dry standpipe system when the water pressure of a building wouldn't be enough for fire suppression and in unheated buildings where the pipes could freeze.

The FLS Director must know the locations of the standpipe risers of the building.

#### (2) Control valves

Control valves are valves controlling flow to water-based fire protection systems. Control valves do not include hose valves, inspector's test valves, drain valves, trim valves for dry pipe, pre-action and deluge valves, check valves, or relief valves. All main and sectional control valves should be clearly labeled with signs indicating the portion of the system that they control. **All main control valves and riser isolation valves must be kept open for normal operations.**

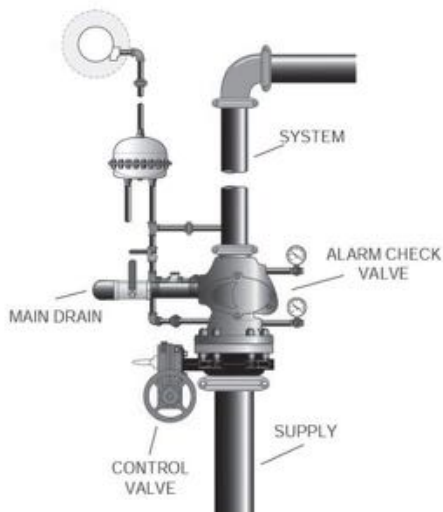

**Main control valve** is the valve that controls the flow of the water from the domestic water supply system and/or fire pump(s). The main control valve is an indicating valve: a fire fighter can tell whether it is open or closed at a glance. The valve is manually operated and, along with other valves, should always be in the open position. The most common type of main water control valve is the OS&Y (Outside Stem & Yoke) valve. It is easy to tell if the OS&Y valve is in the open or closed position. If the stem is raised (OUT) above the control wheel the valve is open. If the stem is flush (IN) with the control wheel the valve is closed. A typical OS&Y gate valve is shown below.



<p>Stem is raised= the valve is open</p>	<p>Stem is flush with the wheel= the valve is closed</p>

**Standpipe isolation valves (riser valve)** are designed to allow isolation of a standpipe of certain floors/areas without impairing additional floors/areas. These valves must be kept open to ensure all floors are properly protected by the standpipe system unless the fire suppression contractor with S-13/S-14 C of F needs to perform maintenance and/or testing or if the firefighters want to shut off or isolate, any given riser or feed that breaks or otherwise fails. The impairment procedures (refer to Section 5.5 of this booklet) must be followed if any isolation valve is closed.

(3) **Hoses and hose outlets**

At selected locations in the building the piping is connected to a hose. These connections are controlled by hose valves. No water is allowed into the hose until the valve is opened. The hose is usually stored on a quick release rack. Hose valve must not be operated for normal testing and maintenance procedure.

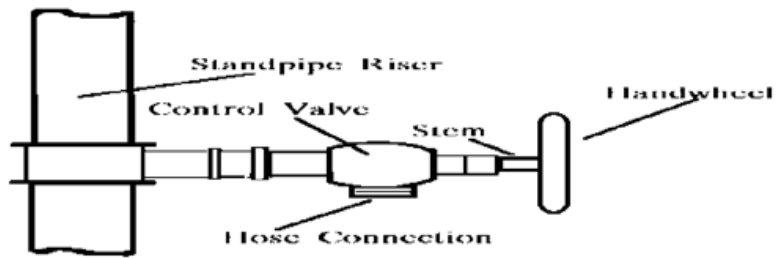

### A Typical Fire Hose Outlet and Release Rack From year 1938-1968

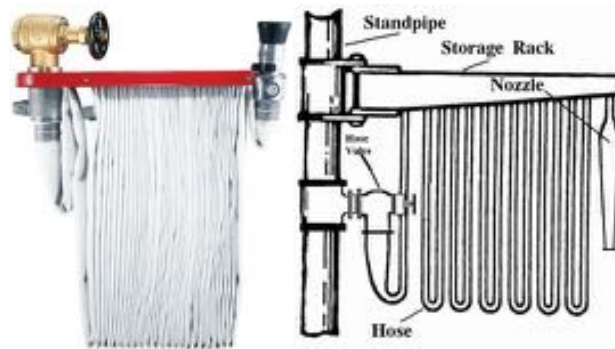

Inclined hose racks are often used, as most existing stations can accommodate such racks. The racks should be located where the sun or excessive heat will not damage the hose. The rack has the advantage of allowing the hose to drain internally while providing a drying area from which fire fighters can easily load and unload hose.

The 2008 Building code requires that the hose connections must be provided in designated areas (e.g. every required stairway, a hose connection must be provided for each floor level, and on each side of the wall adjacent to the exit opening of a horizontal exit, etc.). The FLS Director must be familiar with all locations of hose connections and hose valves.

**(4) Painting of standpipes piping (BC905.11)**

Dedicated standpipe piping valves and handles serving standpipes must be painted and such painting certified in accordance with BC905.11. In addition to painting, standpipe piping may also be identified by lettered legend in accordance with ANSI A13.1. Where the piping is required to be listed and labeled, such painting must not obscure such labeling. Exceptions to when it must be painted include:

- Attachments, gauges, valves and operable parts of standpipes other than valve handles.
- Where different color coding may be required by FC3406 for facilities storing, handling, and using flammable and combustible liquids in connection with special operations.

**All portions of exposed standpipe systems and handles of valves serving the standpipe system of existing buildings were required to be painted red.**

Where a standpipe system that is used as a **combination** standpipe and sprinkler system is required to be painted pursuant to BC 905.11, **the sprinkler risers and cross connections that are also used for the standpipe system must be painted red, and the handles of valves serving such combination standpipe and sprinkler system must be painted yellow.** Certification of compliance with the painting requirements must be maintained on the premises and made available for inspection by the Buildings Department and Fire Department representatives.

**COLOR CODING**

**Local Law 58/09, effective 3/2/2010.**

**Existing buildings must comply by 6/2/2010.**

All exposed standpipes and sprinkler piping must be painted red. The law outlines specific exceptions, such as branch piping.

All buildings – no matter the size or occupancy – must comply with these new requirements.

Dedicated standpipe valve handles must be painted **red**.



Combination standpipe valve handles must be painted **yellow**.



Dedicated sprinkler valve handles must be painted **green**.



**COLOR CODING CERTIFICATION**

**Buildings Under Construction**

The special inspector will confirm compliance before the walls are enclosed.

**Existing Buildings**

Owners of buildings with exposed sprinkler piping and standpipes must comply and hire one of four types of contractors to certify the color coding:

- Licensed master plumbers;
- Licensed master fire suppression piping contractors;
- Registered design professionals; or
- People with the appropriate Fire Department Certificate of Fitness.

**PROOF OF COLOR CODING CERTIFICATION**

The color coding certification must be kept on the premises at all times for Buildings and Fire Department inspection. Visit [nyc.gov/buildings](http://nyc.gov/buildings) for the certification form, available online in March 2010. (over)



Robert D. LiMandri, Commissioner

Michael R. Bloomberg, Mayor



### 5.3.6 Individuals authorized to perform tasks

It is the building owner's responsibility to ensure that the buildings standpipe system is maintained in good working order and to be aware of the Fire Code and Rule requirements, including that the operations, inspection, tests, and other maintenance of the system is personally supervised by an S-13/S-14 Certificate of Fitness holder. The building owner is required to designate an impairment coordinator who must take specific actions when a system goes out of service. **A multi-zone standpipe system must be continuously under the supervision of an S-14 Certificate of Fitness holder. In other words, if your building has multi-zone standpipe system, there must be at least one S-14 C of F holder that could be continuously supervising this system.**

**The FLS Directors with S-13/S-14 C of F are only authorized to conduct visual inspections of a standpipe system.**

The sole FLS Director (without holding an S-13/S-14 C of F) C of F is not authorized to conduct required inspections of a standpipe system; however, the FLS Director must ensure that the standpipe systems are inspected, tested and maintained as the required frequency by the proper C of F or license holder.

The S-13/S-14 C of F holders with different qualifications are permitted to carry different level of responsibilities in inspecting, testing and maintaining the standpipe systems:

<b>Standpipe system (without multi-zone)</b>	Holding S-13 only	Q-01 holding S-13	Master Plumber holding S-13		Master Fire Suppression Piping Contractor holding S-13
Visual inspections	Yes	Yes	Yes		Yes
Perform <u>limited</u> maintenance and test of standpipe system components (refer to the S13/S-14 booklet for detail)	No	Yes	Yes		Yes
Test, maintain and repair/replace all standpipe systems that are NOT combined with sprinkler systems	No	No	Yes		Yes
Test, maintain, and repair/replace all standpipe systems components that are combined with sprinkler systems	No	No	No		Yes

<b>Multi-zone standpipe system</b>	Holding S-14 only	Q-01 holding S-14
Visual inspections	Yes	Yes
Perform <u>limited</u> maintenance and test of standpipe system components (refer to the S-13/S-14 booklet for detail)	No	Yes
Test, maintain and repair/replace all standpipe systems that are NOT combined with sprinkler systems	No	No
Test, maintain and repair/replace all standpipe systems components that are combined with sprinkler systems	No	No

### ***5.3.7 Periodic inspection and testing requirements***

Standpipe systems are required to be maintained in good working order. To ensure that standpipe systems are maintained in such condition, the Fire Code and Rules provide minimum requirements for the periodic inspection, testing, and other maintenance of such systems.

At least once every five years, the Fire Department Connection or connections for a standpipe system shall be subjected to a hydrostatic pressure test to demonstrate its suitability for Fire Department use. **The test shall be arranged to be conducted by a Master Fire Suppression Piping Contractor in the presence of a Fire Department representative and a building representative designated by the building owner.**

Refer to the S-13/S-14 FDNY booklet for the inspection, maintenance, and testing frequency requirements. The FLSD computer based exam will test if the FLS Director candidates know how to refer the frequency chart (refer to appendix A of this booklet).

### ***5.3.8 Recordkeeping***

Standpipe system inspection, testing and maintenance recordkeeping requirements are found in FC901.6.2 and Section 4.3 of NFPA Standard 25. Records of all standpipe system periodic inspections, tests, servicing, and other maintenance required by the Fire Code, Rules and Referenced Standards are required to be maintained on the premises for a minimum of 3 years.

## **5.4 Sprinkler systems**

### ***5.4.1 Introduction***

A sprinkler system is a fire extinguishing system that utilizes water as the extinguishing agent. Sprinkler systems are required by law in various occupancies. 2008 Building Code requires automatic sprinkler system to be installed in all new Group A and Group R-1 (Hotels) occupancies buildings. The existing buildings also may be installed voluntarily by the owner of the building. By 07/01/2019, all office buildings 100 feet or more in height are required to install sprinkler systems for the entire building. Any building with voluntarily installed sprinkler system must also comply with the Fire/Building Code.

The sprinklers are installed to protect the building and its residents. The installation of sprinklers has a major effect in reducing fire losses. About 96% of the fires are extinguished or controlled

when sprinklers are installed. The 4% failure was due to a variety of causes including defective piping, closed supply valves, frozen water lines, improper maintenance, and blocked water supply piping.

Most standard sprinkler systems have devices that automatically sound an alarm when a sprinkler head discharges water. This alarm is an audible signal at the premise. In many cases, an alarm is transmitted to a remote location, such as an approved central station. The central station monitors the entire fire protection system for water discharge and problems with the equipment. When water discharge is identified, in addition to other actions, the central station is required to notify the FDNY dispatch. This notification ensures a rapid response to the building and allows the Fire Department personnel to gain control of a fire as quickly as possible.

#### **5.4.2 Sprinkler system types**

##### **(1) Automatic wet sprinkler systems**

An automatic wet sprinkler system is an effective fire suppression system. It is the most common sprinkler system you can find in an occupied high-rise building. This system discharges water when any sprinkler head is activated by heat. The sprinkler system is designed to extinguish the fire. An automatic sprinkler system consists of a series of pipes at or near the ceiling in a building. The sprinkler system is fitted with automatic devices designed to release water on a fire. These devices are called sprinkler heads. The sprinkler heads are normally closed by a disc or cap. This cap is held in place by a heat sensitive releasing element. A rise in temperature to a predetermined level causes the sprinkler head to open. Water is then discharged in the form of spray. When the sprinkler heads open, they are said to have fused. The sprinkler heads are fitted at standard intervals on the piping. Not all sprinkler heads will be activated at the same time, only the sprinkler heads activated by heat will open. If more than one head opens, the area sprayed by each overlaps that of the sprinkler head next to it.

Automatic sprinklers are very effective for preservation of life and property by discharging water to the burning area. Automatic sprinklers can also effectively reduce heat, flame, and smoke control fire growth; and provide additional time for the building occupants to safely exit the building. The downward force of the water sprayed from sprinklers lowers the smoke level in the room. The sprinklers also serve to cool the smoke.

A wet sprinkler system has water in the piping at all times. The Fire Code requires that all areas of buildings with water-filled piping must be maintained at a minimum of 40 degrees Fahrenheit and be protected from freezing. Where temperatures drop below freezing, the ordinary wet pipe system cannot be used.



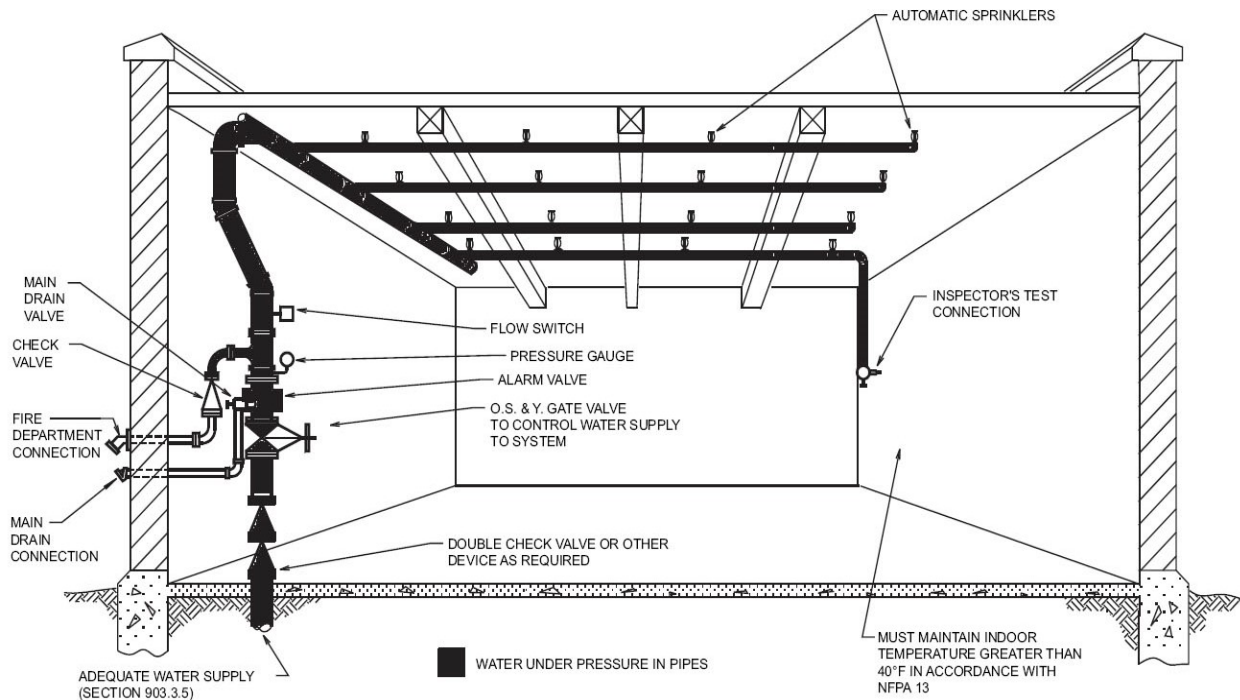

**A TYPICAL WET PIPE SYSTEM**

**(2) Automatic dry sprinkler systems**

A dry pipe sprinkler system employing automatic sprinklers that are attached to a piping system containing air or nitrogen under pressure, the release of which (as from the opening of a sprinkler head) permits the water pressure to open a valve known as a dry pipe valve, and the water then flows into the piping system and out the opened sprinkler heads.

Dry pipe sprinkler systems are installed where it is impractical to install a wet pipe system since the protected area cannot be heated to prevent freezing conditions such as attics, piers, cold-storage facilities, garages, and unheated warehouses. In most cases the air pressure in the piping is controlled automatically by an air maintenance device. A malfunctioning air maintenance device will impair the performance of the dry sprinkler system. If the pressure drops because of air leak, a supervisory signal will be sent to the fire alarm control panel and the central station but it will not be transmitted to the FDNY. However, when a sprinkler head is opened by the heat from a fire, the air pressure is reduced in the piping. The drop in air pressure causes a special dry pipe valve clapper to open. When the clapper has opened, the valve is said to have tripped and an audible and/or visual alarm will be automatically activated at the affected floors. This alarm will also be shown on the fire alarm control panel and it will transmit an alarm to the central station and FDNY. The central station monitors the entire fire protection system for water discharge and problems with the equipment.

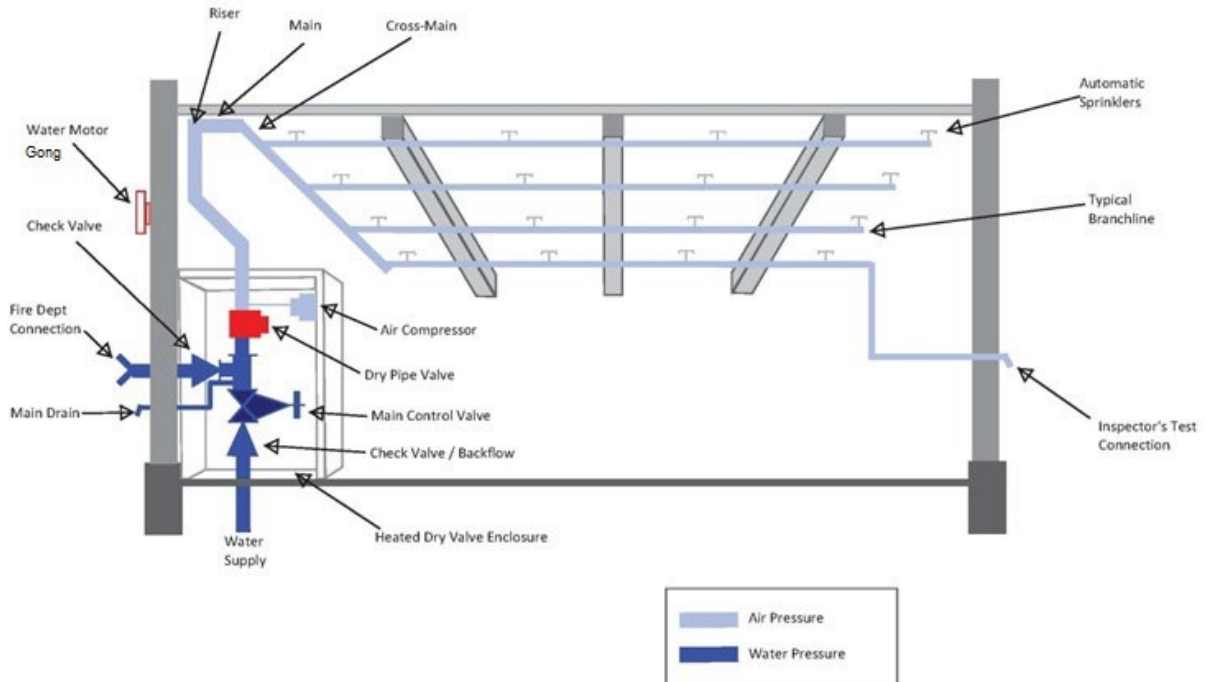

## **A TYPICAL DRY PIPE SYSTEM**

### **(3) Preaction sprinkler systems**

Preaction systems are designed for situations where there is risk of water damage. Water damage is usually caused by damaged sprinklers or broken piping. Under normal conditions, there is no water in the piping. The air in the piping may or may not be under pressure. A preaction valve prevents the water from entering the system. The valve opens automatically upon heat detection or a rise in temperature. The preaction valve is tripped by the fire detection system before any of the sprinkler heads open. The pre-action valve can also be operated manually.

The preaction system has several advantages over a dry pipe system. The preaction valve opens sooner because the fire detectors react to heat changes faster than sprinkler heads. Fire and water damage may be decreased because water is sprayed on the fire more quickly, and the alarm signal is given as soon as the preaction valve is opened.

Heat responsive devices are commonly used to trip pre-action valves. These devices are also used to activate alarm and supervisory systems. There are three main devices used to trip pre-action valves: 1) devices designed to operate at a fixed temperature; 2) devices designed to operate when the temperature in the room increases a set amount in a given time period (rate-of-rise), and 3) devices combining fixed temperature and rate of rise devices. Other ways to activate a preaction valve are smoke detectors, gas detecting systems, hydraulic, electric, manual release, and automatic signals from other safety systems.

When the valve has opened, an audible and/or visual alarm will be automatically activated at the affected floors. This alarm will also be shown on the fire alarm control panel and it will transmit an alarm to the central station and FDNY. The central station monitors the entire fire protection system for water discharge and problems with the equipment.

(4) **Non-automatic dry sprinkler systems**

In this type of system all pipes are normally dry. Water is supplied when needed by pumping water into the system through the Fire Department Connection. Some of these systems are supplied by manual operation of a water control valve and may be equipped with sprinklers with or without fusible links.

There are several non-automatic systems: 1) Perforated pipe systems - a single line of piping drilled at intervals for water discharge. These systems are usually found in basements or other areas difficult to reach in fire fighting operations. 2) Open fixed spray nozzles for transformer vaults or other hazardous areas; 3) exterior exposure sprinklers (or window sprinklers) use open sprinkler heads to form an external water curtain on the walls of a building, and 4) Foam supply systems are used for the protection of special hazardous occupancies.

(5) **Garbage compactor sprinkler systems**

Waste compactors are usually found in tall multiple dwelling complexes such as apartment buildings. They are used to reduce the trash buildup in a building. They consist of a tall chute with an opening at each floor. These openings are used for trash disposal. Occupants of the buildings take their trash and throw it through the opening and down the chute. The trash piles up at the bottom of the chute where a device regularly crushes the trash into smaller blocks of trash. The blocks of trash are then removed and taken to a garbage dump. The compactor may be located indoors or outdoors.

The build-up of trash in the compactor chute is a fire hazard. Fires may be started in several ways, for example, by a smoldering cigarette thrown into the compactor chute. Sprinkler systems must be installed to put out fires that start in the compactor chute. Any of the standard water supply sources may be used to supply the compactor sprinkler system. For example, gravity tanks, fire pumps and pressure tanks are all used as water supply sources.

Fire doors must be installed in the chute to allow firefighter access to burning trash.

The FLS Director must know the location of all sprinkler heads, control valves, supply lines, and compactor rooms. A sketch of the entire compactor sprinkler system must be posted in the compactor room in a frame under glass. The sketch must be made available to any representatives from the Fire Department. A sign indicating the location of all control valves must be kept in the compactor room. This sign - must be displayed with the sketch in the compactor room. All control valves in the sprinkler system must be labeled. The label is to show the purpose of the valve. All indicating valves in the compactor sprinkler system must be sealed open.

(6) **Foam-water sprinkler systems**

Foam is used as a fire extinguishing medium for flammable and combustible liquids. Unlike other extinguishing agents (water, dry chemical, CO<sub>2</sub>, etc.), a stable aqueous foam can extinguish a flammable or combustible liquid fire by the combined mechanisms of cooling, separating the flame/ignition source from the product surface, suppressing vapors and smothering. It can also secure for extended periods of time against re-flash or re-ignition.

Foam-water sprinkler systems and foam water spray systems use low-expansion type foams and are connected to a source of foam concentrate and an automatic water supply. These systems are used primarily for property protection and may be operated both manually and automatically to protect both Class A and Class B hazards using low expansion foam.

The water supply system is activated by detection devices in the same area the sprinklers or discharge nozzles are located. When the control valve operates the water flows into the system

pipng and foam concentrate is injected into the water producing a foam solution that discharges for a specified duration through all open sprinklers or nozzles. In order to extinguish the fire, these systems must be designed using the proper discharge devices, pipe sizes, water pressure and flow rates along with the correct type and volume of foam concentrate along with the appropriate mixing mechanism required to extinguish the fire. The method of fire extinguishment is by covering the fuel cutting off the oxygen supply to the fire along with cooling the fuel due to the water content of the mixture.

Foam-water sprinkler systems may also be used in fire prevention by covering the surface of a flammable or combustible liquid spills to contain the vapors that are subject to ignition.

If building installs foam-water sprinkler systems, the FLS Director must be familiar with the location of the major components of the foam-water sprinkler systems (e.g. locations of the water tanks, foam concentrate tank, fire pumps, foam concentrate pump, all control valves, etc.). The FLS Director should also be familiar with the C of F requirements (refer to Section 5.4.6 of this booklet) and the inspection, testing, and maintenance requirements (refer to Section 5.4.7 of this booklet).

#### ***5.4.3 Water supplies for sprinkler systems***

Sprinklers may be supplied from one or a combination of sources. For example, they may be supplied by public mains, gravity tanks, pressure tanks, fire pumps, reservoirs, rivers, or lakes. The FLS Director must know what is/are the water supply for the building sprinkler systems. A single water supply would appear to be all that is needed to supply a sprinkler fire protection system. This assumes that there is enough water at an acceptable pressure. In some cases, it is required by law to have a secondary water supply source.

##### ***(1) City mains and automatic fire pumps***

Referred to Section 5.3.3 (water supplies for standpipe systems).

##### ***(2) Pressure Tanks***

A pressure tank can provide the needed supply without the use of a pump. All the energy for the system is available from the air pressure in the pressure tank. It is enclosed water tanks of limited size. Air pressure in the tank permits forceful discharge of water in the tank into the sprinkler system. A pressure tank may be used as a primary or secondary water supply for a sprinkler system. A pressure tank is usually housed in an enclosed structure. The temperature in the enclosure is kept at 40° Fahrenheit or above. The heated structure may be located anywhere in the building or even outside the building. Pressure tanks are usually kept approximately two-thirds full of water and one-third full of pressurized air. The air compressor must be provided with automatic controls for maintaining the air pressure. Pressure tanks must be provided with approved closed circuit high and low water and high and low air alarms. Pressure tanks are commonly found at or above the top level of sprinkler systems but may also be located at different locations of a building.

The air pressure in the tank is automatically maintained by an air compressor. If necessary, several pressure tanks can be used in combination to supply the system. A sectional view of a standard pressure tank is shown in the diagram below:

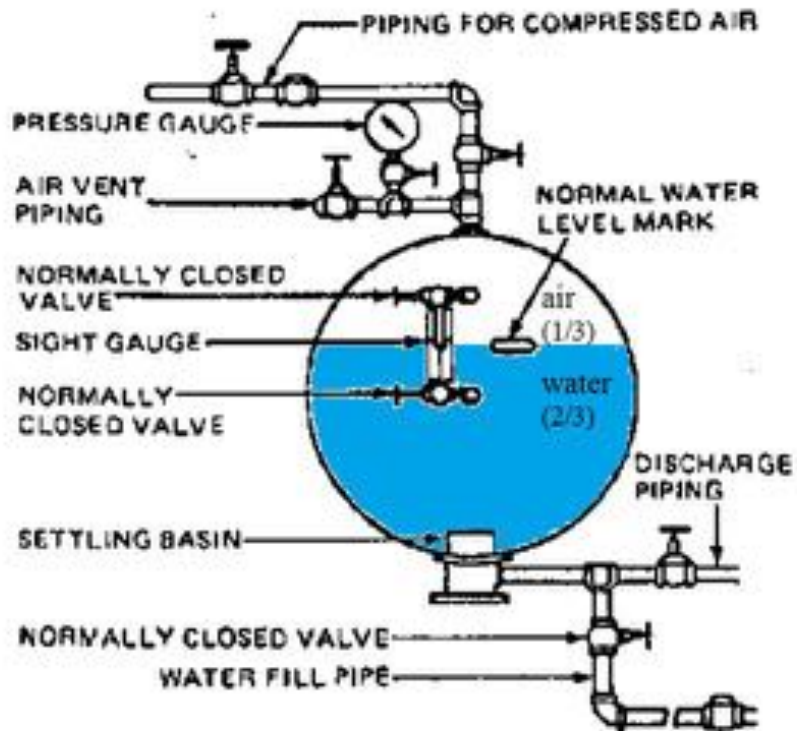

**A Standard Pressure Tank**

**Pressure Tank Alarms**

All pressure tanks used to provide the required primary water supply of a sprinkler system should be equipped with two high and low alarm systems. One system monitors the high and low air pressure. The other system monitors the high and low water levels. The alarm system automatically monitors the air-to-water ratio which should always be 1 (air) to 2 (water). An alarm (high-low) or supervisory signals will annunciate when the water level or the air pressure falls too low. When this happens, the pressure tank must be adjusted or repaired immediately.

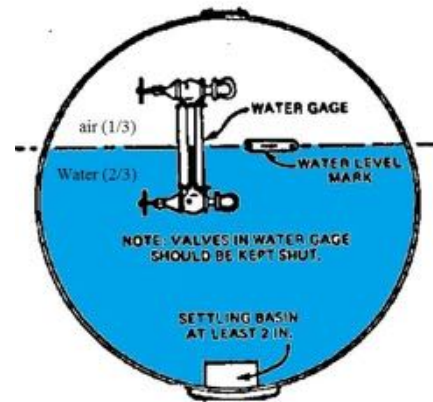

**Supervision of the pressure tank**

The pressure tank may also be supervised by an approved central station, which monitors the sprinkler system. Supervisory devices alert the central station when there is a problem with the tank's water level, air pressure, or water temperature. These devices also alert the central station when water has been discharged from the tank. The central station notifies the building owner when an alarm or supervisory signal is transmitted. It is required that the pressure tank is returned to good working order immediately. The water gauge valve must be opened to examine the water level.

(3) **Gravity tanks**

Referred to Section 5.3.3 (water supplies for standpipe systems).

(4) **Combination gravity tank and pressure tank installation**

Referred to Section 5.3.3 (water supplies for standpipe systems).

(5) **Fire Department Connections**

Normally a sprinkler system is connected to an automatic water supply source. Auxiliary sources of water are supplied through Fire Department Connections at the building. Fire Department Connections are a standard part of most sprinkler systems. When responding to an alarm most Fire Departments supply water to the standpipe system first. The standpipe system supplies water to fire hoses to be used within the building. Water is then supplied to the sprinkler system through its own Fire Department connection.

For **automatic wet sprinkler systems**, the Fire Department can pump supplemental water through the Fire Department Connections into the sprinkler system, standpipe or other system furnishing water for the fire extinguishment to supplement existing water supplies.

For **non-automatic sprinkler systems**, the Fire Department can pump the primary water supply through the Fire Department Connections to the dry system at the required system demand.

Care should be taken that standpipe and the sprinkler connections are properly marked because the connections look the same. The exact purpose of each Fire Department connection should be shown nearby or on the Fire Department connection itself. The New York City Building Code requires Fire Department Connection to be color coded. The Fire Department connection caps on an **automatic sprinkler system** must be painted **green**, and must have the word "SPRINKLER" in letters 1 inch high and 1/8 inch deep cast in the body or on a nonferrous metal plate secured to the connections or mounted on the wall in a visible location, except that caps of Fire Department Connections used for **combination standpipe and sprinkler systems** must be painted **yellow** and the words must read, "COMBINATION STANDPIPE AND SPRINKLER SYSTEMS." The **ENTIRE** Fire Department connection to **non-automatic sprinkler system** must be painted **silver**. Local Law 58/2009 requires color coding of fire standpipe and fire sprinkler systems to have the risers, and cross connections to the water supply piping painted red (for sprinklers BC 903.6 and for standpipe BC 905.11).



Fire Department Connections must always be accessible. A working space of not less than 36 inches in width, 36 inches in depth and 78 inches in height must be provided and maintained in



front of and around wallmounted and free-standing Fire Department Connections, except as otherwise required or approved.

Fire Department Connections serving a sprinkler system protecting only a portion of a building or structure must have durable metal signs securely fastened to, or above, the connection indicating the portion of the building or structure protected.



Fire Department connection must be fitted with a check valve, but not with a gate valve. The check valve prevents the backflow of the private water supply into the public water supply.

The piping between the check valve and the outside hose coupling on the Fire Department Connection should remain empty when the Fire Department Connection is not in use. This piping runs along the outside wall of the building and, if there is water in this piping, there will be danger of the water freezing in the pipe. Such freezing could cause the pipe to burst or could block the pipe, preventing the Fire Department from introducing water

into the piping through the Fire Department Connection in the event of an emergency. To ensure that this piping between the check valve and the outside hose coupling on the Fire Department Connection remains empty when

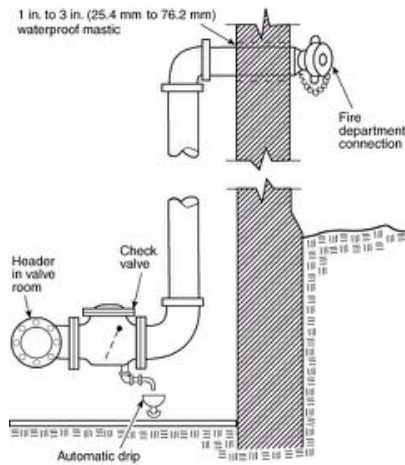

not in use, the piping is equipped with an automatic ball drip device. This automatic ball drip device drips water to empty the piping between the check valve and the Fire Department Connection. Water dripping from the automatic ball drip device indicates one of two things: either there is water in the piping because a hose was recently connected to the Fire Department Connection, either for an emergency or for 5-year hydrostatic testing; or there is water in the piping because the check valve is faulty and is allowing water to flow into the piping. **Water dripping from an automatic ball drip device if a hose was not recently connected to the Fire Department Connection is an indication of a faulty check valve.**

#### 5.4.4 Pumps in sprinkler systems

Referred to Section 5.3.4 (pumps in standpipe systems).

#### **5.4.5 Risers, valves, sprinkler heads, painting requirements, and other common maintenance requirements**

##### **(1) Sprinkler risers**

Standpipe and Sprinkler Risers are the vertical portion of the system piping that delivers the water supply for hose connections, and sprinklers on stand-alone as well as combined systems, vertically from floor to floor.

Most buildings have a wet system where the pipes are kept full of water for manual or automatic fire fighting operations.

Dry risers are used for a dry sprinkler system when the water pressure of a building wouldn't be enough for fire suppression and in unheated buildings where the pipes could freeze.

The FLS Director must know the locations of the sprinkler risers of the building.

##### **(2) Control Valves**

###### **Main control valve**

Gate valves of the non-indicating type are provided in water distribution systems this type of valve is commonly known as curb valve. Gate valves allow the sprinkler system to be shut off for repairs or maintenance. Such valves are normally a non-rising stem type. They are operated using a special key wrench. A valve box is located over the valve to keep dirt from the valve. The valve box also provides a convenient access point for the valve wrench to the valve nut. A complete record should be made for each valve in the system. This record should include the exact location, the date it was installed, the make, the direction of opening, number of turns to open, and any maintenance that was performed.

The control valve for the building may also be on the outside wall or attached to an upright post, known as a post indicator valve (PIV). The building or section of the building controlled by the valve is usually marked on the post. The position of this valve (open or closed) is shown through a telltale opening in the post. On some posts, a padlock must first be opened to release the operating wrench or wheel handle.

The main water supply for sprinklers may also be controlled by an OS&Y valve (Outside Stem and Yolk valve). The valves are found just inside the building wall on the main riser, or outside in protected pits. It is easy to tell at a glance if the valve is open or shut. When the stem is all the way out the valve is open. When the stem is all the way in, the valve is closed. A closed control valve is an out-of-service situation. All impairment procedures must be followed.



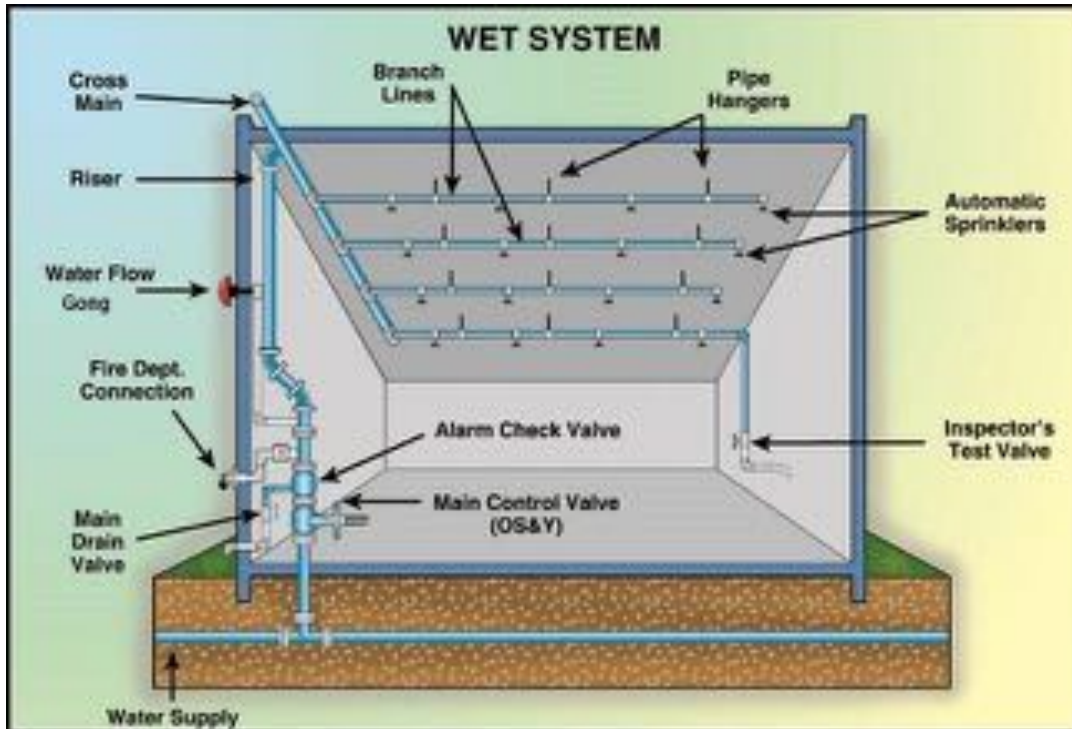

**Sprinkler system control valve Signage**

A sign identifying the location of the sidewalk box housing the sprinkler system control valve must be conspicuously posted on the exterior wall of the building directly opposite the sidewalk box. Such sign must have red letters 1 inch in height on a white background and read, "Sprinkler System Shutoff Valve (indicate distance) feet opposite this sign" or other approved design.



### **Zone/section control valves**

Zone control valve controls the water supply to a zone area or a section of the building. Different zone/section control valves control the different areas of the building. Some section control valves may be designed to shut off certain sections of an individual floor and some may be designed to shut off water supply for several floors. This type of valve is commonly combined with flow switch, tamper switch, pressure gauge, and test and drain valves. It helps to separate areas in case of maintenance and to get the indication of fire zone.

Sometimes repairs must be made to the sprinkler system. When this occurs the indicating control valves are used to close the water supply to only those sections being repaired. This is a good safeguard since the rest of the sprinkler system does not have to be shut down.

### **Floor control valves**

Floor control valves are dedicated control valves designed to control the water supply for individual floors in a building. Being able to shutoff parts of a building allows the Fire Department to have greater control over the sprinkler system. When a fire is under control in an area, the OS&Y valve can be closed to prevent any further water damage.

Besides OS&Y valve, the indicating butterfly valve may be found next to the floor control valve. This type of valve using a yellow tab to indicate the position of the valve. Similar to the OS&Y valve, it is easy to tell if the control valve is in the open or closed position: If the valve is open then the indicator is in line with the direction of the pipe. If the indicator is perpendicular to the pipe, then the valve is shutting off the flow.



The green valve is a floor control valve. In this photo, the control valve is in the open position.



The picture shows the control valve is in the closed position.

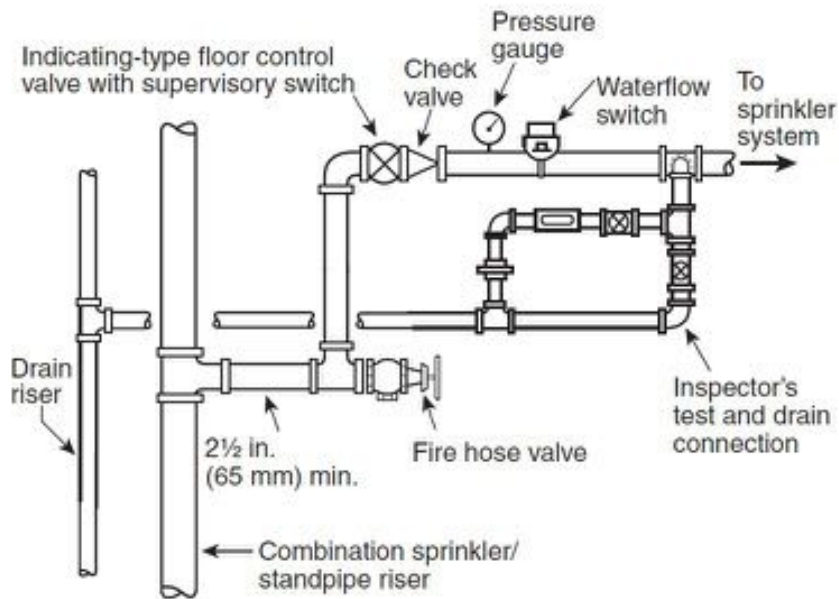

**Combined Sprinkler/Standpipe System (NAPA 14, 2007 edition)**

Sprinkler systems are excellent for controlling fires. However, they can cause water damage if they are not shut down soon after the fire has been extinguished. No control valve on the system should be closed except on the order of the FDNY representative in charge. If the fire has been completely extinguished, the building owner or their representative may close the control valve. Sometimes the Fire Department has a difficult time finding the control valve to shut down the system. This problem can be prevented by keeping a small sketch of the sprinkler system and the position of the control valves. This sketch should always be readily available. This sketch is very helpful to the firefighters when they are responding to an affected premise. **The FLS Director must know the location of the sprinkler system main control valve and all indication control valves.**

**(3) Sprinkler heads**

Sprinkler heads are made of metal. They are screwed into the piping at standard intervals. The water is prevented from leaving the sprinkler head by an arrangement of levers and links.

The most efficient and reliable way to put out a fire is to spray the water from the sprinkler head downward and horizontally. The spray pattern will also prevent the spread of the fire. The force of the water against the deflector creates



a heavy spray which is directed outward and downward. The shape of the deflector determines the spray pattern of the water discharged from the sprinkler head. Usually, this is an

umbrella shaped spray pattern.

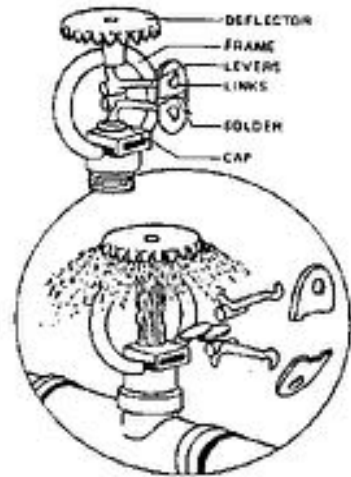

**A Typical Sprinkler Head**

**Concealed Sprinkler heads**

Concealed sprinkler is a recessed sprinkler with a cover plate. Concealed fire sprinkler heads above ceilings with cover plates are commonly found in many buildings. It provides a finished look and also protect the sprinkler head from accidental contact and possible activation. When the activation temperature is achieved, the cover plate will fall off allowing the sprinkler head deflector to drop below the ceiling height and distribute the water after the sprinkler activates. The FLS Director must ensure that no cover plates is painted, glued, or caulked since it may cause the sprinkler head to be inoperative.



Concealed fire sprinkler heads with cover plates



Adjustable Concealed Sprinkler Heads



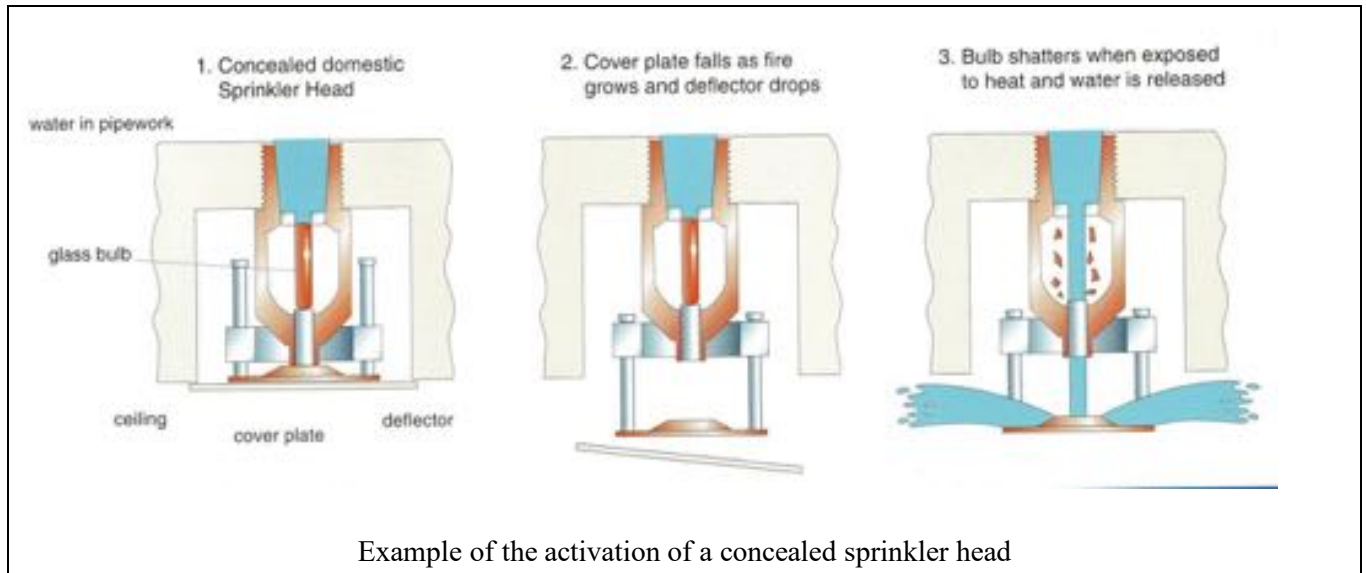

**Sprinkler Spray patterns must not be obstructed by building components or storage.** For example, any storage of materials must be maintained a minimum of 18 inches below sprinkler head deflectors in areas protected by a sprinkler system.

### **Spare sprinkler heads**

A stock of spare sprinklers (not less than 6) must be kept on the premises where the temperature does not exceed 100 Degrees F and must include all types and ratings installed in the protected facility and provided as follows:

**1 - 300** sprinkler heads on premises; **six spare sprinkler heads.**

**301 - 1000** sprinkler heads on premises: **twelve spare sprinkler heads.**

**Over 1000** sprinkler heads on premises: **twenty four spare sprinkler heads.**

### **(4) Painting of sprinkler piping (BC905.11)**

Dedicated sprinkler piping and valve handles must be painted (as indicated in the following paragraphs) and such painting certified in accordance with BC903.6. In addition to painting, sprinkler piping may also be identified by lettered legend in accordance with ANSI A13.1. Where the piping is required to be listed and labeled, such painting must not obscure such labeling.

Exceptions to what must be painted include:

- Attachments, gauges, valves, and operable parts of sprinkler systems other than valve handles.
- Horizontal branch lines.
- Where different color coding is required by Section 3406 of the New York City Fire Code for facilities storing, handling, and using flammable and combustible liquids in connection with special operations.

In new buildings: Cross connections and risers must be painted red and the handles of valves serving dedicated sprinklers must be painted green prior to the hydrostatic pressure test regardless of whether they will be enclosed at a later point in time.

Exception: where a standpipe system is used as a combination standpipe and sprinkler system, the sprinkler risers and cross connections that are also used for the standpipe system must be painted red and the handles of valves serving such combination system must be painted yellow.

Altered buildings: Cross connections and risers for independent (stand-alone) existing sprinkler systems that are exposed during alterations must be painted red and the handles of valves serving such existing sprinkler systems must be painted green. Where the alteration requires a hydrostatic pressure test such painting must be completed prior to such test.

Exception: Where a standpipe system is used as a combination standpipe and sprinkler system, the sprinkler risers and cross connections that are also used for the standpipe system must be painted red and the handles of valves serving such combination system must be painted yellow.

All exposed risers and cross connections of completed buildings in existence on March 2, 2010 were required to be painted red by June 2, 2010, and all handles of valves serving such sprinkler system must be painted green.

Exception: Where a standpipe system is used as a combination standpipe and sprinkler system, the sprinkler risers and cross connections that are also used for the standpipe system must be painted red and the handles of valves serving such combination system must be painted yellow.

**COLOR CODING**  
**Local Law 58/09, effective 3/2/2010.**  
**Existing buildings must comply by 6/2/2010.**  
All exposed standpipes and sprinkler piping must be painted red. The law outlines specific exceptions, such as branch piping.  
All buildings – no matter the size or occupancy – must comply with these new requirements.

Dedicated standpipe valve handles must be painted **red**.

Combination standpipe valve handles must be painted **yellow**.

Dedicated sprinkler valve handles must be painted **green**.

**COLOR CODING CERTIFICATION**  
**Buildings Under Construction**  
The special inspector will confirm compliance before the walls are enclosed.  
**Existing Buildings**  
Owners of buildings with exposed sprinkler piping and standpipes must comply and hire one of four types of contractors to certify the color coding:

- Licensed master plumbers;
- Licensed master fire suppression piping contractors;
- Registered design professionals; or
- People with the appropriate Fire Department Certificate of Fitness.

**PROOF OF COLOR CODING CERTIFICATION**  
The color coding certification must be kept on the premises at all times for Buildings and Fire Department inspection. Visit [nyc.gov/buildings](http://nyc.gov/buildings) for the certification form, available online in March 2010. (bvar)

Robert D. LiMandri, Commissioner

Michael R. Bloomberg, Mayor

#### 5.4.6 Individuals authorized to perform tasks

It is the building owner's responsibility to ensure that the building's sprinkler systems are inspected, tested and maintained as required by NFPA Standard 25 (2011 edition) by a competent person holding an S-12/S-15 Certificate of Fitness or other qualifications as detailed below to see that all parts of the sprinkler system are in good working order. **A water-based sprinkler system must be supervised by an S-12/S-15 Certificate of Fitness holder; however, a foam-water suppression system must be supervised by an S-15 Certificate of Fitness holder.** The S-12/S-15 Certificate of Fitness holder or other qualified person who conducts the visual inspections and tests must maintain records that must be available for FDNY inspection. An FLS Director needs an S-12/S-15 Certificate of Fitness to make official visual inspections of sprinkler system. However, any FLS Director should still pay attention to any significant out-of-service issue regarding the sprinkler system component. For example, a hanger or pipe bracing is defective, a sprinkler head is loaded or covered in dirt or grease, etc.

There are certain periodic visual inspections, tests, and maintenance required by the Fire Code that the S-12/S15 Certificate of Fitness holder may perform and some that they cannot without additional qualifications (refer to S-12/S-15 FDNY Certificate of Fitness booklet). The table below provides details of the qualifications required for individuals perform various tasks:

	Holding S-12/S-15 only	Q-01 holding S-12/S-15	Master Plumber holding S-12/S-15	Master Fire Suppression Piping Contractor holding S-12/S-15
Visual inspections	Yes	Yes	Yes	Yes
Perform <u>limited</u> maintenance and test of sprinkler system components (refer to the S-12/S-15 booklet for the detail)	No	Yes	Yes	Yes
Test, maintain and repair/replace all sprinkler systems components, but limited to residential occupancies 30 sprinkler heads or less without a booster pump.	No	No	Yes	Yes
Test, maintain and repair/replace all sprinkler systems components	No	No	No	Yes

#### **5.4.7 Periodic inspection and testing requirements**

Sprinkler systems are required to be maintained in good working order. To ensure that sprinkler systems are maintained in such condition, the Fire Code and Rules provide minimum requirements for the periodic inspection, testing, and other maintenance of such systems. Refer to the FDNY S-12/S-15 Certificate of Fitness booklet for the detail.

At least once every five years, the Fire Department connection or connections for a sprinkler system shall be subjected to a hydrostatic pressure test to demonstrate its suitability for Fire Department use. **The test shall be arranged to be conducted by a Master Fire Suppression Piping Contractor in the presence of a Fire Department representative and a building representative designated by the building owner.**

The FLSD computer based exam will test if the FLS Director candidates know how to refer the frequency chart (refer to appendix A of this booklet).

#### **5.4.8 Recordkeeping requirements**

Records of all sprinkler system inspections, tests, servicing and other maintenance required by this code, the rules, or the referenced standards must be maintained on the premises for a minimum of 3 years and made available for inspection by any Fire Department representative.

### **5.5 Out-of-service fire protection systems**

The building owner must designate an impairment coordinator to take the actions required by the Fire Code when a standpipe system, sprinkler system, or fire alarm system is out of service.

**Impairment Coordinator:** The building owner must assign an impairment coordinator to comply with the Fire Code requirements. In most cases, the FLS Director or the building evacuation supervisor may be designed as an impairment coordinator. The impairment coordinator must take the action(s) when a standpipe system, sprinkler system or fire alarm system is out of service.

The impairment coordinator must maintain records of all system inspections, tests, servicing and other items of maintenance to be kept on the premises or other approved location for a minimum of 3 years and made available for inspection by any member of the FDNY.

When the FLS Director or FLS staff observes a minor defect or other condition not presenting a serious safety hazard, he or she must also report the defect or condition to the owner.

#### **5.5.1 Fire watch**

The building must be evacuated or a fire watch maintained when a standpipe system, sprinkler system, or fire alarm system is out of service. Such fire watch must be conducted in compliance with the requirements as listed below:

- continuously patrol the area affected by the out-of-service fire protection system to which such person has been assigned, keeping constant watch for hazardous conditions;
- be provided with at least one approved means for notification of the Fire Department and any Fire and Life Safety Director, Fire and Emergency Preparedness Coordinator, or Fire Safety Plan staff on the premises;
- immediately report any fire or smoke to the Fire Department and notify emergency preparedness staff on the premises;
- be trained in the use of portable fire extinguishers and equipped with a portable fire extinguisher, or made aware of the location of readily accessible portable fire



extinguishers in the area to which such person has been assigned to maintain a fire watch;

- if safe to do so, be responsible for extinguishing fires when they are limited in size and spread such that they can readily be extinguished using a portable fire extinguisher;
- maintain a record of such fire watch on the premises during the fire watch and for a minimum of 48 hours after the fire watch has concluded; and
- have no other duties during the fire watch.

**5.5.2 Fire guard**

The fire watch required for an out-of-service standpipe system, sprinkler system, or fire alarm system must be maintained by one or more fire guards (qualified fire guards include F-01 C of F holder: Fire Guard for Impairment).

For the initial 4 hours of an unplanned and planned out-of-service condition when the affected area does not exceed 50,000 square feet, the impairment coordinator or a trained and knowledgeable person who is capable of performing fire watch duties and is designated by the building owner may perform the duties of the fire watch.

In other words, the impairment coordinator or a trained and knowledgeable person designated by the building owner should immediately begin conducting a fire watch in the area where the fire protection systems are out of service. However, an on-duty Fire and Life Safety Director is not allowed to perform fire watch since the fire watch personnel must have no other duties during the fire watch patrol. After 4 hours of an out of service condition, such patrols must only be conducted by fire guards holding the F-01 Certificate of Fitness.

The number of fire guards generally depends on the location and the size of the area affected by the out-of-service fire protection system. A fire guard should be available to patrol all areas in which the fire protection system is out of service at least once every hour. No individual fire guard should patrol more than 50,000 square feet of building floor area. (How big is 50,000 square feet: A playing portion (without end zones) of a football field is roughly 57,000 square feet.) To meet this standard, it may be necessary that more than one fire guard be designated.

The required coverage for performing fire watch in affected area(s) is summarized below.

Area	Planned or Unplanned	
	The initial 4 hours	> 4 hours
≤ 50,000 ft <sup>2</sup>	An F-01C of F holder or an impairment coordinator or a knowledgeable person	One F-01 C of F holder trained and knowledgeable person
> 50,000 ft <sup>2</sup>	One F-01 C of F holder for each 50,000 square feet	

The fire guard must be maintained continuously, 24 hours a day, until such systems are restored to good working order. In some cases, Fire Department personnel may be on scene and provide additional direction on the number of required fire guards or other fire protection measures that may be required until such time as the fire protection system is restored to good working order.

The fire guard for impairment is recommended to be familiar with the types of Fire Safety and Evacuation Plans for the buildings where they provide fire watch and the associated staff available to implement the plan. The fire guard must be familiar of his or her obligations to notify the Fire Department in the event of fire.

### **5.5.3 Planned removal from service**

The impairment coordinator must be made aware in advance of any planned removal from service of a standpipe system, sprinkler system, or fire alarm system, or system component, for repair, servicing, alteration, testing and other maintenance of the system or component or to allow construction to be performed in the area protected by the system without unnecessarily activating it. The impairment coordinator must authorize and personally supervise the placing of the fire protection system out of service. Before authorizing the placing of the fire protection out of service, the impairment coordinator must:

- notify the Certificate of Fitness holder responsible for supervising the maintenance of the standpipe system, sprinkler system, or fire alarm system.
- determine the extent and expected duration of the out-of-service condition.
- inspect the areas or buildings involved and assess the increased risks.
- make appropriate recommendations to the owner.
- notify the Fire Department, if required.
- notify the responsible person designated by the owner to issue hot work authorizations.
- notify the central station and insurance carrier.
- notify the occupants in the affected areas if the duration of time the sprinkler system or fire alarm system will be out of service is estimated to be more than 30 minutes.
- place a disc at each Fire Department Connection and place a tag at standpipe and sprinkler system control valve and Fire Command Center, indicating which fire protection system, or part thereof, is out of service.
- maintain the fire protection system in service until work is ready to begin.
- record out-of-service information and situation in the logbook.

### **5.5.4 Unplanned out-of-service condition**

Any person, upon becoming aware of any condition, except a planned removal from service, rendering a standpipe system sprinkler system or fire alarm system, or part thereof, inoperable in whole or in part, must notify the owner and the impairment coordinator of such condition. The impairment coordinator must take the actions set forth in FC901.7.3 and 901.7.5 (e.g. Section 5.5.3 of this booklet) and such other actions as are necessary or appropriate to protect the occupants of the building and promptly restore the system to service.

### **5.5.5 Notification to the Fire Department**

The Fire Department must be notified that a standpipe system, sprinkler system, or fire alarm system is out of service, whether by reason of a planned removal from service or an unplanned out-of-service condition.

- Standpipe systems. Notification must be made to the Fire Department whenever a standpipe system is or will be out of service for any period of time.
- Sprinkler systems and fire alarm systems. Notification that a sprinkler system or fire alarm system, or any part thereof, is or will be out of service must be made to the Fire Department under the following circumstances:
  - The sprinkler system or fire alarm system is or will be out of service on more than one floor of a building; or
  - With respect to a sprinkler system, the work or repairs cannot be completed and the system restored to service, within 8 hours of the time the system was placed or went out of service; or
  - With respect to a fire alarm system, the work or repairs will require the fire alarm system to be out of service for more than 8 hours in any 24-hour period; or
  - One or more other fire protection systems in the area in which a fire protection system is out of service are or will also be out of service at the same time.
- Reporting requirements. Notification of an out-of-service condition must be made by the impairment coordinator to the borough dispatcher of Fire Department at the applicable telephone number as below:

<b>Manhattan</b>	<b>(212) 570-4300</b>
<b>Brooklyn</b>	<b>(718) 965-8300</b>
<b>Queens</b>	<b>(718) 476-6200</b>
<b>Bronx</b>	<b>(718) 430-0200</b>
<b>Staten Island</b>	<b>(718) 494-4296</b>

Such notification must include the following information:

- The type of occupancy;
- The owner or impairment coordinator's name and contact information;
- The building address;
- The type of fire protection system that is out of service;
- Whether the fire protection system is out of service by reason of a planned removal from service (and if so, the reason for placing it out of service) or an unplanned out-of-service condition;
- If a planned removal from service, the date and time the fire protection system will be placed out of service and the estimated duration the system will be out of service;
- If an unplanned out-of-service condition, the estimated duration the system will be out of service;
- The floors or areas in which the fire protection system is out of service;

- Whether the other fire protection systems are in good working order; and
- The name and certificate number of the Certificate of Fitness holder responsible for supervision of the fire protection system that is out of service.

**5.5.6 Required tag or signs**

Systems that are out of service, both planned and unplanned, must be immediately identified by placing a tag/disc at each of the following locations: **Fire Department Connections, standpipe and sprinkler system control valves, Fire Command Center, indicating which fire protection system or part thereof, is out of**

**service.**

The impairment coordinator shall authorize the placement of system(s) out of service that are planned to be shut down. The impairment coordinator shall notify the qualified Certificate of Fitness holder about the system(s) that is/are out of service.

A clearly visible tag alerts building occupants and the Fire Department that all or part of the water-based fire protection system is out of service. The tag should be weather resistant, plainly visible, and of sufficient size [typically 4 in. x 6 in.]. The tag should identify which system is impaired, the date and time impairment began, and the person responsible.

Different tag colors indicate the level of impairment or defect as follows:

Tag color	Impairment condition
Red	Full or partially impaired, owner and FDNY must be notified, must be fixed immediately (e.g. air pressure in pressure tanks is not correct; control valve is closed or inaccessible, Fire Department Connection is not accessible, piping is leaking, etc.)
Orange	Critical Deficiency, owner must be notified, must be corrected within 30 days or FDNY must be notified. (e.g. water level in tank is not correct; the temperature is less than 40 °F in the pump room; piping may be subject to freezing conditions; etc.)
Yellow	Non-critical deficiency, owner must be notified, must be corrected within 30 days or FDNY must be notified. (e.g. tank supporting structure is damaged; main control valve is not sealed/locked or supervised; identification sign of Fire Department Connection is missing, etc.)
Green	System fully operational

An FLS Director is authorized to place a tag/placard over the defective component of the fire alarm system indicating that device is out of service for less than 8 hours.

An FLS Director or a refrigerating system operating engineer (Q-01) with the S-12/S-15 C of F may take the sprinkler system out of the service for less than 8 hours and place an appropriate colored tag on those systems. However, only FDNY, Master Fire Suppression Contractor, or Master Plumber (as restricted) is authorized to place a tag on a standpipe system. For systems that are fully or partially out of service that are not equipped with Fire Department Connections, the appropriate tags shall be placed at the main control valve. FDNY is to be notified immediately.

An impairment disc should be placed on the Fire Department connection to alert responding fire fighters of an abnormal condition. For example, a **disc (white or blue) should be placed at all affected Fire Department Connections** to inform responding Fire Department units of the out of service condition (**blue disc indicates partial out-of-service condition; white disc indicate completely out-of-service condition**). The impairment coordinator/building owner must ensure placement of these discs by Master Fire Suppression Contractor (Class A or B), a Master Plumber (as restricted), or FDNY units. When the condition has been corrected, the disc(s) must be removed immediately.



### ***5.5.7 Restoring systems to service***

When an out-of-service device, equipment, or system is restored to service, the impairment coordinator must:

- conduct necessary inspections and tests to verify that the affected systems are operational.
- notify the Fire Department.
- notify the owner, central station, insurance carrier, emergency preparedness staff (e.g. FLS staff), and, if previously notified, the occupants in the affected areas.
- ensure that- the out-of-service tags/discs be removed.
  - record that the system is operational in the logbook.

## Chapter 6. Other Fire Safety-Related Building Systems

### 6.1 Elevators and different modes of elevator operation

#### 6.1.1 Special operating modes

There are different special operating modes for elevator emergency operations: Phase I emergency recall operation, Phase II emergency in-car operation, and manual (independent) mode.

##### (1) Common key-operated switch

Elevators with fire service systems are generally outfitted with a three-position, key-operated switch in both the lobby and elevator cars. The key configuration on the lobby panel and elevator car panel will vary, depending on the age of the elevator and the standards in effect when the fire service system was installed. The newer systems have "on," "off," and "bypass" key positions in the lobbies and "on," "off," and "hold" key positions in the cars.

Older systems may be labeled "firefighter's service" or "normal" instead of "on" and "off."

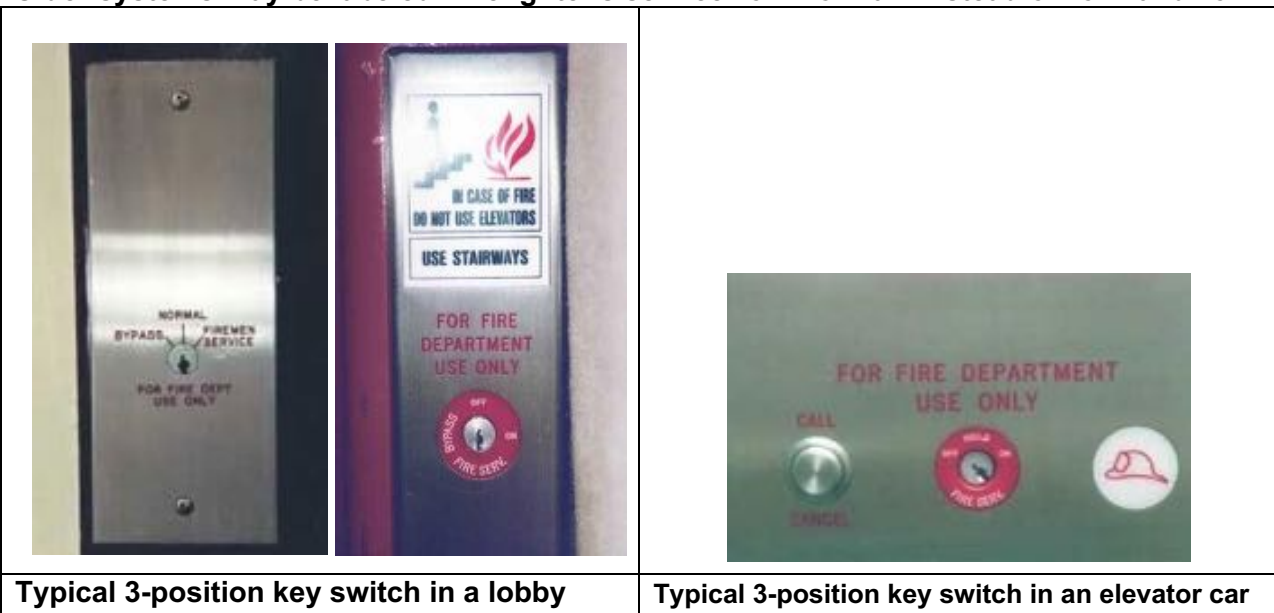

The following introduction presents the common design of the key switch panels. The key configuration on the lobby panel and elevator car panel may vary, FLS Director must be familiar with his or her own building elevator operation procedures.

"On"/"firemen's service" position is both a lobby and car panel key position that places the system into fire service. Switching the key to the "on"/"firemen's service" position engages the fire service system.

Turning the lobby panel to "on"/"firemen's service" activates Phase I and recalls the elevators.

Turning the car panel to "on" activates Phase II, manual control of the car. The "on" position replaces the key position labeled "fireman's service" in older installations. (Note: the lobby switch must be in Phase 1 in order to put the car in Phase II)

"Off" is both a lobby panel and car panel key position. Turning the car panel switch to "off" will return the elevator car from Phase II to Phase I elevator operation and return the car to the lobby for use by later arriving units, provided that the lobby panel is keyed to the "on" position. Switching the

lobby switch to "off" will disengage the elevators from fire service and return them back to normal functioning. "Off" replaces the key position labeled "normal" in older installations.

If the key is turned to "off" in the lobby, the car will not come out of Phase II unless the car panel switch is also turned to "off" and removed the car from Phase II.

"Hold" is a car panel key position used to keep the car on the floor you exited with the doors open. You can remove the firefighter's service key from the panel when it is in the "hold" position, and the car won't move from that position until you return with the key.

### **(2) Phase I emergency recall operation**

Phase I emergency recall operation generally requires that elevator landings and elevator machine rooms be provided with smoke detectors that, when activated, will recall the elevator to a safe location (e.g. lobby) where the elevator doors will open. The doors may stay open or may close later depending on how the elevators are programmed. Such recall is also required for sprinkler waterflow alarms.

In the event a smoke detector fails or if emergency responders wish to use the elevator such as for the transportation of equipment in the treatment of a patient, a key switch is provided in the elevator lobby. The key switch can be activated by the use of the citywide standard key (2642 key) or fire department standard key (1620 key). Turning key to "On" or "Fireman's service" will activate the Phase I recall operation and recall it to the lobby level where the elevator doors will open. The doors may stay open or may close later depending on how the elevators are programmed. A recall of an elevator bank will affect only the elevator cars serving that bank.

When the elevator is recalled, it proceeds to the recall floor (e.g. lobby) and stops with its doors open. The elevator will no longer respond to calls or move up and down. Located on the fire recall floor (e.g. lobby floor) is a fireman's service (lobby key switch). In most cases, the fire recall floor can be identified by the key switch. The fireman's service has the ability to turn fire service off and turn fire service on. The only way to return the elevator to normal service is to switch it to normal position after the alarms have been reset. However, if the key is turned to "off" on the lobby floor, the car will not come out of Phase II unless the car panel switch is also turned to "off" and removed the car from Phase II.

### **(3) Phase II emergency in-car operation**

Phase II emergency in-car operation allows firefighters to control the elevator and travel to any floor served by the elevator. The operating controls are located inside of the elevator car. When the elevator is placed into the fire service mode, the elevator can only be operated by personnel in the elevator car.

Phase II operation is for emergency use only. Only trained personnel or first responders should use this feature.

Common actions in elevator car to perform the Phase II operation (every elevator may vary, FLS Director should be familiar with his or her own elevator design):

1. Insert the key in car and turn to "firemen's service (on)" position.
2. Press the selected floor button and then press DOOR CLOSE.

You may need to hold the DOOR CLOSE button until the door is fully closed (This feature will depend on how the elevators are programmed. The FLS Director must know how their elevators are programmed for Phase I and Phase II.).

3. Before reaching the selected floor, press CALL CANCEL (RESET).

This CALL CANCEL (RESET) button is to change previously selected floor.

4. Press another floor button.
5. When the car reaches the new selected floor, press DOOR OPEN and hold until door is fully open.

Once the elevator gets to the desired floor, it will not open its doors unless the first responder holds the door open button. This is in case the floor is burning and the first responder can feel the smoke or heat and knows not to open the door. The doors will close unless the door open button is pressed until it has fully opened .

After the door has fully opened, the first responder should turn the key to the “hold” position to make sure the elevator remains at that floor and no other person can operate the elevator (the passenger panel will be disabled); the elevator car will remain with door open on the floor until redirected by first responder.

6. Turn the key to “fire service” position to continue Phase II operation.
7. Once Phase II operation is completed, the first responder will return the elevator to the lobby. When the elevator return to the lobby, press the DOOR OPEN button until the door is fully open. After the door has fully opened, turn the key to the “normal” position. The elevator will only be under Phase I operation.
8. Elevator will function normally once the Phase I has been removed.

#### **(4) Manual mode operation**

Manual (independent) mode is a special service mode found on most elevators. It is activated by a switch either inside the elevator itself or on a centralized control panel in the lobby. This special mode is usually used for non-fire emergencies or when transporting large freights or moving groups of people between certain floors.

When an elevator is placed in manual (independent) mode, it will no longer respond to other calls. In a bank of elevators, the traffic is rerouted to the other elevators, while in a single elevator, the lobby buttons are disabled. The elevator will remain parked on a floor with its doors open until a floor is selected and the door close button is held until the elevator starts to travel. In some elevators, the operator needs to hold the button of the desired floor until the elevator starts moving.

An elevator in the manual (independent) mode must respond to Phase I recall.



**Examples of independent switches:**

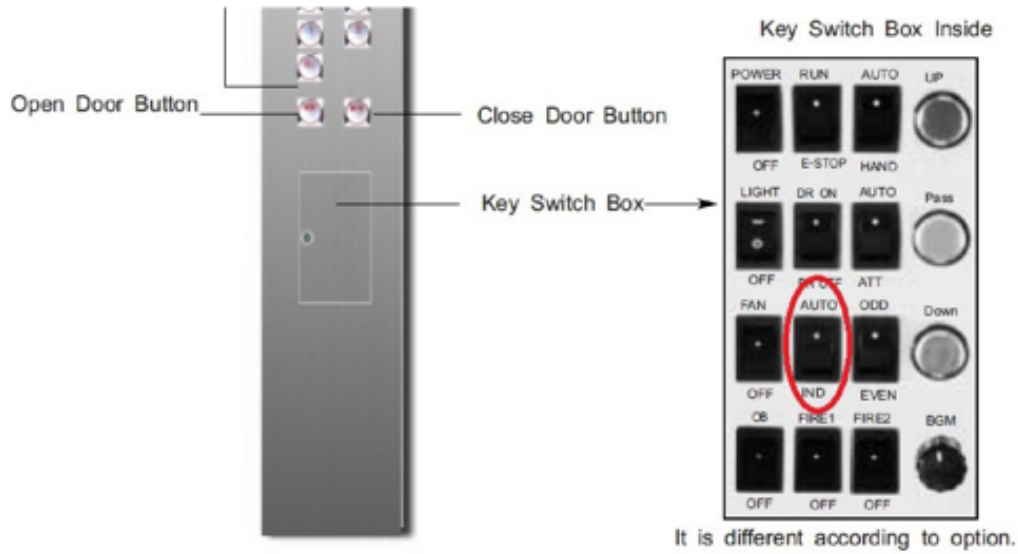

**(5) Required operation skills for FLS Directors**

A Fire and Life Safety Director, must be fully capable of

- (1) utilizing Phase I emergency elevator recall,
- (2) utilizing Phase II emergency in-car operation including the following:
  - a. closing the elevator door,
  - b. canceling the floor selection, and
  - c. opening the door utilizing the built-in safety feature.

- (3) placing an elevator car designated in your Comprehensive Fire Safety and Emergency Action Plan in the manual (independent) mode (NOT PHASE II).

Manually operate a designated elevator car in the manual (independent) mode including the following:

- a. closing the elevator door,
  - b. moving the elevator to the designated floor,
- (4) Communicating from the Fire Command Center
    - a. acknowledging the call from the occupants in the elevator
    - b. initiating communication with occupants inside the elevator.

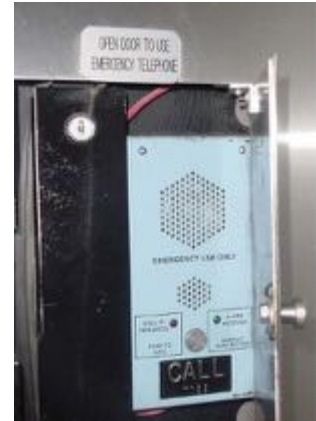

### **6.1.2 Elevator in readiness**

Building occupants safety and firefighting operations depend on these systems to function properly during emergency conditions. It is critical that the elevators be maintained in good working order at all times.

Elevators in every building 75 feet or more in height must be kept ready for immediate use by the department during all hours of the night and day including holidays and weekends. There must be a competent building attendant available to operate such elevators, except that no attendant must be required for buildings between 75 and 150 feet in height having elevators with Phase I emergency recall operation and Phase II emergency in-car operation.

All elevators equipped with Phase I emergency recall operation and Phase II emergency in-car operation must be maintained in proper working order such that the emergency elevator operations are operable at all times. All elevators with Phase I emergency recall operation must be subjected, **at least monthly**, to a **Phase I recall test**. All elevators with Phase II emergency in-car operation must be subjected, at least **monthly**, to a **minimum of a one-floor operation II test**.

### **6.1.3 Keys and key access**

**Citywide standard key** is a key of special or controlled design, also known as a “2642” key, approved by the FDNY which serves to operate elevator emergency recall and emergency in-service operation service switches and other devices or locks as required by the construction codes, including the Building Code, the Fire Code or the Fire Rules.

**Fire department standard key** is a key of special or controlled design, also known as a “1620” key, for the use of FDNY personnel and others specifically authorized by the FDNY, which serves to operate all switches, locks and other devices required to be operable by a citywide standard key.

**Fire Code requires all keys for the elevator car doors and firefighter service key switches to be kept in an approved location (e.g. Fire Command Center) for immediate use by the Fire Department.**

**It is unlawful to possess a fire department standard key, except for authorized department personnel and other approved persons.** The fire department key serves to operate all switches, locks, and other devices required to be operable by a citywide standard key.

It is unlawful to possess a citywide standard key except for persons authorized to possess such key in connection with the following purposes:

1. Owners of buildings equipped with firefighter service elevators, or their authorized representatives, including FLS Directors and FEP coordinators.
2. Elevator contractors.
3. Elevator inspectors of the Department of Buildings.
4. Persons authorized to conduct testing and other maintenance or servicing of fire alarm systems.
5. Authorized department personnel.
6. New York City police officers and other approved law enforcement personnel.
7. Building owners required to have key boxes, locked boxes or locked gates or barriers pursuant to the Fire Code, or their authorized representatives.
8. Building owners with locked gates and barriers that block required fire department and fire apparatus access.
9. Locksmiths or other authorized key suppliers when in connection with their lawful business operations.

Citywide-standard keys must be able to operate the firefighter service elevator key switches and must be allowed to provide access to

- (1) key boxes,
- (2) gates and barriers, and
- (3) other locked areas, boxes or cabinets to which the department requires access for firefighting operations.

**(1) Key boxes**

The FDNY recommends that at least 6 citywide standard keys (2642) should be available for emergency or first responders' use.

A key box is a secure device with a lock operable only by a citywide standard key or other approved key. Where access to or within a building, structure or premises is restricted because of locked doors or other building openings, or where immediate access would be needed for lifesaving or firefighting purposes in the event of a fire or other emergency, the department may require that keys be kept in a key box installed in an approved location. The owner must ensure that the key kept in the lock box is replaced whenever a lock securing the area, box or cabinet is changed or rekeyed. Gate and barriers

**(2) Gate and barriers**

Wherever a gate or similar barrier obstructs fire department access or fire apparatus access to a premises, and a lock is installed on such gate or barrier, the lock must be of an approved type and operable by a citywide standard key.

**(3) First responder box**

The fire department may require that a locked box operable by a citywide standard key be provided in a designated area in a building, structure or premises to store plans, building information cards or other materials (e.g. Fire Command Center) that will assist firefighting personnel responding to a fire or other emergency at the premises.

## **6.2 Maintenance of the means of egress**

### ***6.2.1 Unobstructed and unimpeded egress***

It is unlawful to obstruct or impede access to any required means of egress, including any exit, exit access, or exit discharge. All required means of egress, including each exit, exit access, and exit discharge, must be continuously maintained free from obstructions and impediments to immediate use in the event of fire or other emergency. All required means of egress must be maintained free from the accumulation of snow and ice.

It is unlawful to store combustible materials or combustible waste in corridors.

Door hardware and other devices and physical components of the means of egress must be maintained in good working order at all times. Security devices affecting means of egress must be subject to the approval of the Commissioner of Buildings in consultation with the commissioner.

### ***6.2.2 Prevent overcrowding***

Premises must not become overcrowded by the persons present on the premises that will obstruct or impede access to any means of egress. It is unlawful to cause overcrowding, maintain an indoor or outdoor space in an overcrowded condition, or allow an indoor or outdoor area or space to become overcrowded. The FDNY may order remedial actions necessary to abate the overcrowding condition and prevent future recurrence of such condition, including suspending or terminating the event or other gathering, vacating the premises, enforcing the lawful use and maximum occupancy of the premises, and/or requiring the provision of fire guards.

### ***6.2.3 Furnishings and decorations***

Furnishings, decorations, or other objects must not be placed so as to obstruct exits or exit access. Furnishings and decorations must not be placed in building hallway corridors or elevator lobbies (except as authorized by FC 1027.4 provided that the minimum required egress width is maintained). Hangings and draperies must not be placed over exit doors or otherwise be located to conceal or obstruct an exit. Mirrors must not be placed on exit doors. Mirrors must not be placed in or adjacent to any exit in such a manner as to confuse the direction of exit.

### ***6.2.4 Stairway door operation and fail-safe system***

Buildings built in different years may have different stairway door operations and fail safe systems. FLS Directors must be familiar with the stairway door operation and the fail safe system in their building. The first responders will require the detail information regarding the operation and fail safe system of their building.

Stairway is usually fireproof in a high-rise building and are used by the occupants to evacuate or to move between floors during an emergency. However, stairways do not always terminate at the lobby or at the roof.

FLS Directors, must be familiar with the servicing areas/floors that each stairway can reach. FLS Director and FLS staff have to select the correct stairway for the building occupants to use for different fire or non-fire emergencies. The stairway doors may be locked from the stairway side and/or be provided with a "fail safe system."

The following table summarizes the different building codes requirements for different high-rise buildings.

Building code	Building height	Stairway door operation	Fail safe system
1968	≤100 ft.	Doors may be locked to prevent access to the stairs at the street floor. Doors may be locked from the stairway side on each floor above the street floor.	NA
1968	≥100 ft.	Doors may be locked to prevent access to the stairs at the street floor. The doors may be locked on the stair side above the street floor except that at intervals of <b>four stories</b> or less, doors must be openable or be equipped with fail-safe devices from the stair side.	It will be activated in the event of (1) the activation of any automatic fire detecting device, or (2) when any elevator in readiness is activated. The doors equipped with fail-safe devices will be unlocked, but the other doors without fail-safe devices are still locked.
2008 and 2014	≥75 ft.	All door must be openable. However, door locked from the stair side may be permitted provided that such door is equipped with an automatic fail safe system.	It will be activated in the event of: (1) the activation of any automatic fire detection system, or (2) when any elevator recall is activated, or (3) when any signal is received from the Fire Command Center.

A “fail safe system” is an electronically controlled device, which will allow a stairway door to be opened when the device is activated. This means that a door that is usually locked from the stair side will in time of emergency be unlock.

A “fail safe release device” will operate whenever the following occurs:

- An automatic fire –detecting device is activated
- Elevator is activated in Phase I
- A power failure occurs
- Manual operated from the Fire Command Center

If Fire Command Center is equipped with a manual release switch, FLS Director can release the fail safe system by activating the switch.

Based on the NFPA 72 (2010) requirement, the emergency control functions (e.g. door holder release, shutter release, door unlocking, etc.) must be tested by operating or simulating alarm signals. The fail safe system must be tested at least annually.

### 6.3 Signs

Several types of safety signs are required to be posted at different locations inside the building. The signs are made to protect the occupants. The signs mentioned below majorly are based on the Local Law 76 of 1968 (revised in 2003) unless specified otherwise. Buildings built pursuant to 2008 or 2014 Building Code must comply with the new signage requirements.

### 6.3.1 Exit signs



FLS Director, must make sure that all exits signs and emergency exit lighting are in proper working order.

#### **The 1968 Building Code requirements:**

##### **(a) Hotels**

The location of every exit on every floor and every opening from a room and containing cubicles must be clearly indicated by exit signs.

Such signs must be placed at an angle with the exit opening if such placement is required for the signs to serve their purpose. In long corridors, in open floor areas, and in all other situations where the location of the exit may not be readily visible or understood, directional signs may be required to serve as guides from all portions of the corridor or floor.

##### **(b) High rise office buildings:**

- (1) All doors opening to corridors, to an exit, or to an exit passageway shall be marked with the word "exit."
- (2) Within exit stairs, horizontal extensions in exit stairs, horizontal exits, supplemental vertical exits and exit passageways, except within street level lobbies, there shall be directional markings.
- (3) Illuminated exit signs complying with the 1968 Building Code must be placed in stairwells with horizontal extensions to indicate the transition from vertical to horizontal direction and at turns along the horizontal path. A supplementary sign, indicating the location of a recessed re-entry door, must be securely attached on the wall of the landing that faces the evacuee on the stairs.
- (4) Signs must be readily visible from the egress direction.
- (5) Other additional exit sign requirements must be complied with the 1968 Building Code.

##### **(c) Assembly places**

Exit signs must be provided in all assembly spaces to indicate the location of exits and, where necessary, the direction to the exits. All exit or directional signs must be placed so that they are clearly visible from all parts of the assembly spaces, and the bottom of all signs must be at least seven feet above floor level. Signs must be of the internally lighted type in all assembly spaces and be lighted at all times while occupied.

**The 2008 Building Code requirements:**

Exits and exit access doors must be marked by an approved exit sign readily visible from any direction of egress travel. Access to exits must be marked by readily visible exit signs in cases where the exit or the path of egress travel is not immediately visible to the occupants. Exit sign placement must be such that no point in an exit access corridor is more than 100 feet or the listed viewing distance for the sign, whichever is less, from the nearest visible exit sign.

In high-rise buildings, exit signs must be placed within exits at horizontal extensions to indicate the transition from vertical to horizontal direction and at turns along the horizontal path. All exit signs must be internally or externally illuminated except tactile exit signs. A tactile sign stating EXIT must be provided adjacent to each door to an egress stairway, an exit passageway and the exit discharge. The illuminated exit signs must be illuminated at all times and the letters of the signs must be red.

**6.3.2 Non-exit door identification sign**

Any door, passageway, stair, or other means of travel that is not an exit or that is not a way to an exit, but is so located as to be mistaken for an exit, must be identified with a sign reading "NOT AN EXIT," must be identified by a sign indicating its use or purpose, or must be provided with a directional exit sign.



**6.3.3 Signs at elevator landings**

These signs should be directly above the call button and its top must not be above 6 feet from the floor level. a. *Elevator landing sign*

On all floors other than the main entrance floor, a sign must be posted and maintained on every floor at the elevator landing. The sign must read,

"IN CASE OF FIRE, USE STAIRS UNLESS OTHERWISE INSTRUCTED."

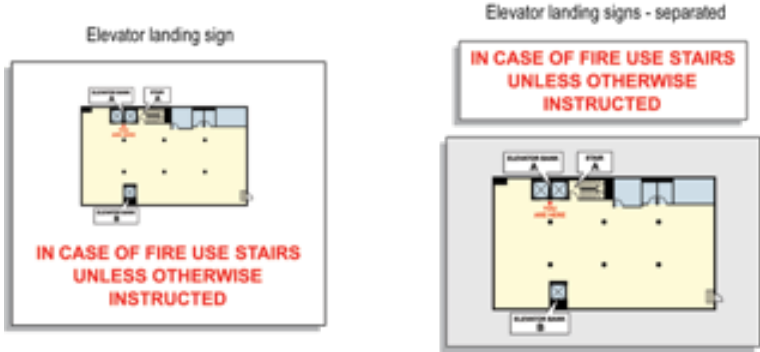

However, buildings built pursuant to the 2008 Building Code regulations must provide the following sign language for the elevator landing sign:

**“IN FIRE EMERGENCY, DO NOT USE ELEVATOR. USE EXIT STAIRS”**



***Floor diagram signs***

The sign must contain a floor diagram showing the location where it is posted and the location and letter identification of the stairs on the floor and each elevator bank.

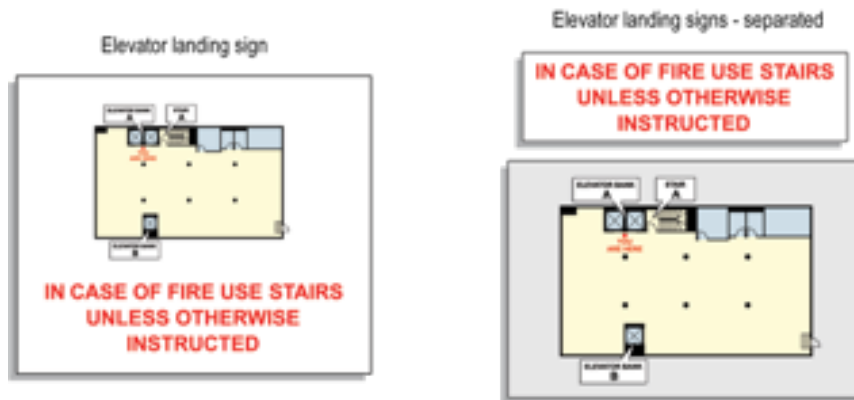

**6.3.4 Floor number signs**

Floor numbering signs must be posted and maintained within each stair enclosure on every floor. The floor numbering sign must be posted and maintained on the stair side of the door, or if no door, nearby on the wall or an adjacent conspicuous place.

**6.3.5 Stair and elevator identification signs**

Each staircase and each bank of elevators must be identified by an alphabetic letter. A sign indicating the letter of identification for the elevator bank must be posted and maintained at each elevator landing directly above or as part of the elevator landing sign

The staircase identification signs must be posted and maintained on both sides of the door, or if no door, nearby on the wall or an adjacent conspicuous place.



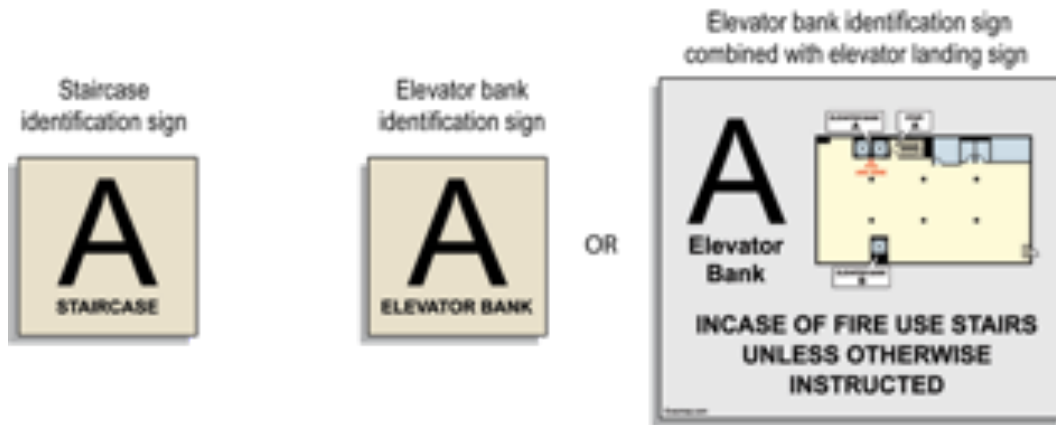

### 6.3.6 Stair re-entry signs.

Stair re-entry signs must be posted and maintained on the stair door at each floor in buildings, occupied or arranged to be occupied for an occupant load of more than a total of 500 persons in the entire building indicating re-entry is provided. The signs must be attached approximately five feet above the floor. The signs must read as follows:

#### (A) **Where no re-entry is provided:**

- (i) Where no re-entry is provided from the stairs to any floor, the sign must read "NO RE-ENTRY FROM THIS STAIR" and such sign must be posted and maintained on the occupancy side of the stair door at each floor. No re-entry sign must be required on the stair side of the door.
- (ii) On every floor where fail-safe re-entry locking devices are installed on exit doors, a sign reading "NO RE-ENTRY FROM THIS STAIR EXCEPT DURING FIRE OR EMERGENCY" must be posted on the occupancy side of the stair door.



#### (B) **Where re-entry is provided to specified floors:**

- (i) On the stair side of the door at floors where re-entry is provided, the sign must read, "RE-ENTRY ON THIS FLOOR".
- (ii) Where no re-entry is provided on that floor, the sign on the stair side of the door must read, "NO REENTRY, NEAREST RE-ENTRY ON THE \_\_\_ AND \_\_\_ FLOORS." The floor numbers of the nearest re-entry below and the nearest re-entry floor above must be entered in the blank spaces.



### 6.3.7 “No-smoking” sign

Durable “No Smoking” signs must be conspicuously posted at all entrances to facilities in which smoking has been entirely prohibited and any area therein where hazardous materials are stored, handled, or used. Facilities or areas within such facilities in which smoking is allowed in designated areas must have signs indicating that smoking is allowed in designated areas only.

The signs must be provided in English as a primary language. A posted “No Smoking” sign must not be removed, obscured, or rendered illegible.

The Fire Department has published an approved “No Smoking” sign. It is set forth in Fire Department rule (as the following figure).

However, the Fire Department does not mandate that this design be used. Other legible, durable signs, clearly communicating the “no smoking” requirement, may be used but are subject to Fire Department enforcement action if found to be inadequate.



### 6.3.8 Signs/ Documents for Place of Assembly Occupancies (Certificate of Operation, FDNY PA permit, and Maximum occupancy signs)

A Place of Assembly (PA) Certificate of Operation is required for premises where 75 or more members of the public gather indoors or 200 or more gather outdoors, for religious, recreational, educational, political, or social purposes, or to consume food or drink.

The Department of Buildings performs the initial inspection for the first issuance of a Place of Assembly Certificate of Operation. It is unlawful to occupy any building or space as a place of assembly unless and until a Certificate of Operation therefore has been issued by the Department of Buildings.

(Example of the new Place of Assembly Certificate of Operation.)

The Certificate of Operation issued after May, 2013 does not expire. However, within one year after the issue date, FDNY will inspect the establishment and provide the premises with a Place of Assembly Permit based on the results of that inspection. All place of assembly occupancy will be subject to annual PA inspection and must obtain the annual FDNY PA permit. As with the PA Certificate of Operation, the PA Permit must be posted in a location that is visible to people entering the establishment.



A sign indicating the number of people that may legally occupy the space, as determined by the Certificate of Occupancy, must be also created and posted. It should read:

OCCUPANCY BY MORE THAN \_\_\_\_\_ PERSONS  
IS DANGEROUS AND UNLAWFUL

Public Assembly License No. \_\_\_\_\_ Commissioner  
(where applicable) Dept. of Buildings, City of New York

When a space is occupied for multiple purposes involving different occupant loads, the sign, issued by the Department of Building prior May 2013, must read as follows:

<p>OCCUPANCY BY MORE THAN (number)____ PERSONS AS ____ (type of occupancy)____ OR BY (number)____ PERSONS AS ____ (type of occupancy)____ OR BY (number)____ PERSONS AS ____ (type of occupancy)____ IS DANGEROUS AND UNLAWFUL Public Assembly License No _____ Commissioner, (where applicable) Dept. of Buildings, City of New York</p>
---

The capacity signs must be at least 12 inches wide and 16 inches high. The lettering must be red on a white background. The letters must be at least 1 inch high and the numerals at least 1¼ inches high. The signs must be framed under a transparent protective cover and permanently mounted in a location that is conspicuously visible to a person entering the space. The signs must be lighted by artificial illumination at all times during occupancy to maintain at least five foot candles on the surface of the sign.

**6.3.9 Other signs/notice required in Hotels**

**(1) Guest room doors with floor diagrams**

Signs with floor diagrams must be posted on or immediately adjacent to every required egress door from each guest room.

**(2) Fire and emergency notice**

A fire and emergency notice must be posted on or immediately adjacent to the main entrance door of guest rooms in Group R-1 (e.g. Hotels) occupancies and any emergency shelter. The notice must provide the following information and guidance as the commissioner may prescribe by Fire Rule:

1. A visual representation of the location to each exit stairway, the route thereto, and the number of doors opening onto the public corridor that must be passed to reach each such stairway.
2. Location of manual fire alarm boxes.
3. A written description and/or visual representation of the procedures to be followed in the event of a fire, smoke condition or other emergency.

**(3) Guest room identification, directional markings and signs**

The Fire Department adopted a rule in 2016 to set forth standards and requirements for the design and placement of entrance door room number markings for dwelling units (apartments, guest rooms and sleeping rooms) in Group R-1 (Hotels) and Group R-2 buildings and occupancies, and building lobby and building hallway corridor directional signs, which serve to

assist emergency response personnel in locating such dwelling units when responding to fires, medical emergencies and other emergencies at the premises. The design and the location can be referred to the Fire Rule 505-01.

**(4) Fire emergency markings**

Dwelling units (apartments, guest rooms, and sleeping rooms) and stairway entrances in Group R-1 (Hotels) must be marked in accordance with the Fire Rule 505-02 to facilitate firefighting and emergency rescue operations at the premises.

The marking of entrance doors with emergency markings serves to better facilitate firefighting operations, thereby providing a greater level of safety to firefighters and building occupants. The fire emergency marking enables firefighters to identify apartment numbers in smoke conditions that obscure the regular (eye-level) door numbers. Such identification ensures firefighters can more quickly conduct search and rescue operations.

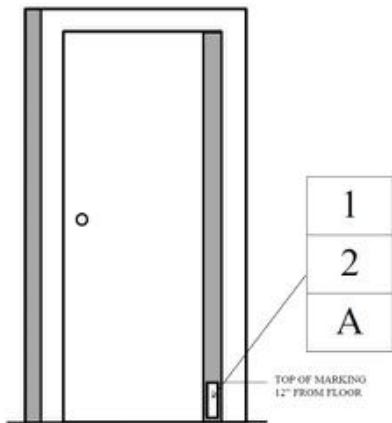

The sample figure depicts the location and vertical configuration of the fire emergency marking for a dwelling unit designated as 12A and having a single entrance. Other examples should be referred to the Rule 505-02.

Buildings and occupancies existing on May 31, 2016, must be brought into compliance with the new requirements by March 30, 2018, except that buildings and occupancies must be brought into compliance with multi-floor dwelling unit fire emergency markings by March 30, 2017. Buildings and occupancies with a certificate of occupancy or temporary certificate of occupancy dated on or after June 1, 2016, must be compliant

with such requirements prior to occupancy of the building or occupancy.

**6.4 HVAC systems, smoke control systems, and post-fire smoke purge system**

*6.4.1 Heating Ventilation and Air Conditioning (HVAC) systems*

The heating, ventilation and air-conditioning functions are interrelated to provide thermal comfort and acceptable indoor air quality. The HVAC systems provide ventilation, reduce air infiltration and maintain pressure relationships between spaces.

HVAC systems include equipment used to:

- Ventilate
- Heat and cool
- Filter and clean
- Dry or humidify the air

A good HVAC management system can help to limit the spread of fire and to control the movement of smoke within the building. This system also provides assistance to the firefighters who are being deployed to control the fire, and who are conducting the search for any trapped occupants or fire.

To utilize the HVAC system to its full potential during a fire-related emergency in a high-rise building, the firefighters will need to gather information from the FLS Director and building engineer about how the HVAC system functions.

The HVAC systems found in high-rise buildings fall into two general categories:

- (1) Central air conditioning system: The fan or fans serve multiple floors and the system supplies more than one floor.
- (2) Package air conditioning system: Each package unit serves only the floor (or a zone) on which the unit is located.

Central air conditioning systems are more commonly found in high-rise buildings and can create more complicated problems during a fire. The central air conditioning system will be the main emphasis of this section.

The HVAC system may be divided into three sub-systems: processing equipment, supply of processed air to the floors of the building, and return of the air from the floors to be reprocessed. The processing of the air is usually done on the floors of the building where the mechanical equipment rooms are located. In a typical centrally airconditioned high-rise building, the large volume of air required precludes the use of a single HVAC system. We will usually find a number of HVAC systems each supplying a group of floors. These groups are referred to as HVAC systems supply zones.

Building HVAC systems are typically controlled by a Building Management System (BMS), which allows for quick response to shut down or selectively control air conditioning systems. A Building Management System is a computer-based control system installed in buildings that controls and monitors the building's mechanical and electrical equipment such as ventilation, lighting, power systems, fire alarm systems, and security systems. In case a fire or smoke is detected by a smoke detector in the air duct, the programmed BMS will automatically initiate the shutoff of the HVAC systems. The duct smoke detector will also transmit an alarm signal to the fire alarm panel.



After the condition is verified by FDNY firefighting personnel, the HVAC system is allowed to be manually restarted from the BMS by the building engineer.

FLS Director, must consult with building engineers to be familiar with the fire protection and the interface with HVAC system. They must also obtain the following information concerning the HVAC system:

- A. Location of the mechanical equipment room and the zones they supply.
- B. Special HVAC zones in the building (theaters, restaurants, computer rooms, stores, etc.)
- C. Central control of the HVAC systems and their location.

#### **6.4.2 Smoke control systems**

Smoke control systems are commonly found in the buildings relying on mechanical ventilation. Smoke (carbon monoxide and other products of combustion) is the greatest threat to life in the event of a building fire or explosion. While the fire may be localized, the smoke will travel wherever the building airflow will take it. Appropriate smoke control systems maintain smoke-free paths of egress for building occupants through a series of fans, ductwork, and fire smoke dampers.

Smoke control systems can be found in buildings such as hospitals, covered malls or other buildings containing atriums, high-rise buildings, and buildings with smoke protected seating.

There are two categories of smoke control systems: dedicated systems and non-dedicated systems.

Dedicated systems are those that don't perform any other functions. The fans and dampers are not used for everyday ventilation, only for controlling smoke during fire or fire-related emergencies. These are often found in stairways and elevator shafts to prevent the spread of smoke.

Non-dedicated systems provide HVAC in the building every day, but are captured by the smoke-control system in the event of a fire. There are numerous types of non-dedicated systems, based upon the HVAC design. However, the smoke control system should always capture the fans and dampers in the event of a fire, in order to control smoke.

*(1) **Smoke control systems maintenance***

Fire Code requires that smoke control systems be maintained in good working order. It requires a written maintenance program, including periodic inspection and testing, to be established and implemented immediately upon installation of the smoke control system.

Dedicated smoke control systems must be tested semiannually. Non-dedicated smoke control systems must be tested annually. **All systems must be tested under both normal power and emergency power.**

*(2) **Smoke control systems recordkeeping***

A logbook or other approved form of recordkeeping documenting each inspection and testing of smoke control system must include the date of the maintenance; identification of servicing personnel; description of any operating defects or deficiencies; notifications made; corrective action taken, including parts replaced; and/or other information prescribed by the Fire Department by rule. The 2014 Building Code requires that the **records be kept for at least the last 5 years of operation and must be made available for inspection by the Fire and the Building Departments.**

**6.4.3 Smoke proof enclosure and stair pressurization**

Both smoke proof enclosures and stair pressurization are smoke control systems, which are designed to produce pressure differences across smoke barriers that establish airflows to limit and direct smoke movement.

*(1) **Smoke proof enclosure***

Smoke proof enclosure is an exit stairway designed and constructed so that the movement of the products of combustion produced by a fire occurring in any part of the building into the enclosure is limited.

Smoke proof enclosures must consist of one of the following systems:

1. An enclosed interior exit stairway accessed through an open exterior balcony (e.g. fire towers).
2. An enclosed interior exit stairway accessed through a naturally ventilated vestibule (e.g. fire towers).
3. An enclosed interior exit stairway accessed through a mechanically ventilated vestibule.
4. A pressurized interior exit stairway (e.g. stairway pressurization).

Doors in a smoke proof enclosure must be self-or automatic-closing by actuation of a smoke detector and must be installed at the floor-side entrance to the smoke proof enclosure. The actuation of the smoke detector on any door must activate the closing devices on all doors in the smoke proof enclosure at all levels. Smoke detectors must be installed.

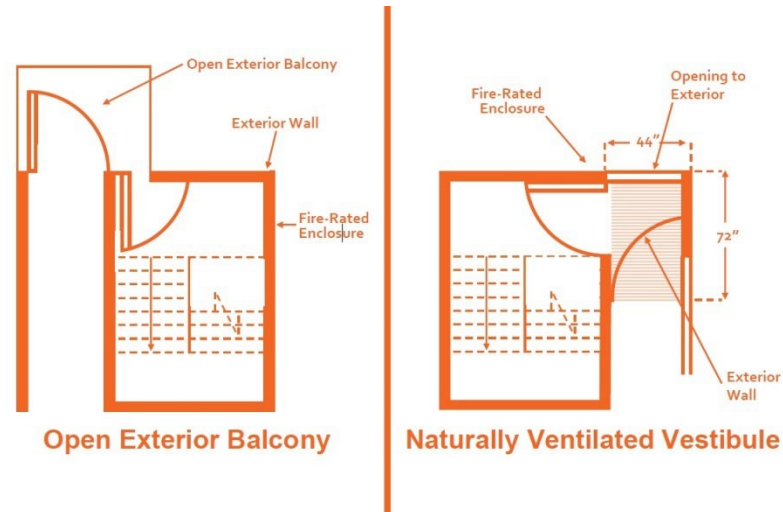

## (2) **Stair pressurization**

Pressurization is a creation and maintenance of pressure levels in building zones, including elevator shafts and stairways, that are higher than the pressure level at the smoke source, such pressure levels being produced by positive pressures of a supply of uncontaminated air; by exhausting air, and smoke at the smoke source or by a combination of these methods.

Stair pressurization is the process by which fans are activated within a stair enclosure to pressurize it and prevent smoke from entering that stairway. Upon activation of a fire alarm automatic initiating device, fresh air is introduced into the stairway to maintain a pressure difference between the stairs, and the floor area that the pressure in the stair is greater than the adjacent fire compartment. Then, if the stair door is opened, the system is intended to maintain a flow of air through the open doorway to oppose smoke spread and prevent contamination of the stair enclosure. It is very important that all other outlets/doors to the stairway remain closed to ensure the pressurization is adequate.

Improving other conditions within the stair can improve the speed of occupant egress via the stair, and thus limit the time of exposure to any potentially hazardous environment within the stair. For example, adequate stair lighting, photo luminescent stair/path lighting, and adequate door/stair widths may greatly increase the speed of occupant travel within the stair in a smoky environment, in combination with a stairway dilution system or other ventilation option.



#### 6.4.4 Smoke shaft

'Smoke shaft' is the common term for ventilation systems in the floors of tall buildings, used to maintain tenable conditions in the common escape routes in the event of a fire in the building. Smoke shafts may be found in high-rise buildings pursuant to the 1968 Building Code. Buildings that are sprinklered throughout are exempt from the smoke shaft requirements.

Smoke shafts are essentially a simple ventilation system designed to extract any smoke leaking into a common floor to protect the escape stairs. Typically, a vertical building's duct work rising through the building would be used to extract smoke from the floors, and each floor would have a damper connected to the building's duct work.

#### 6.4.5 Smoke compartment

A space within a building enclosed by smoke barriers on all sides, including the top and bottom. The smoke compartment is required in any existing office building if the building:

- is over 100 feet in height;
- has air-conditioning and/or mechanical ventilation systems that serve more than the floor on which the equipment is located;
- is not fully sprinklered; and
- is more than 40 feet above curb level.

These buildings must be subdivided by fire separations into spaces or compartments of the size required by the Building Code. For example, all unsprinklered floor areas must be segregated by one-hour fire separations into spaces or compartments not to exceed 7,500 square feet. The other details can be referred to Building Code Title 27 Subchapter 5 Article 5 Section 27-339 (c).

Since Local Law 16/1984 required all new construction office buildings over 75 feet in height be fully sprinklered, compartmentation requirements will only be applicable to the high-rise office buildings built prior to 1984 and not being fully sprinklered.

#### 6.4.6 Post-fire smoke purge system

As more and more buildings are sealed tightly with un-openable windows to conserve energy, there are problems after the fire in venting the building of the smoke and gases. In order to expedite that process and allow the building to be reentered more quickly, all high-rise office and hotel buildings will be required to have a manual smoke purge system. Post-fire smoke purge system is a mechanical or natural ventilation system intended to move smoke from the smoke

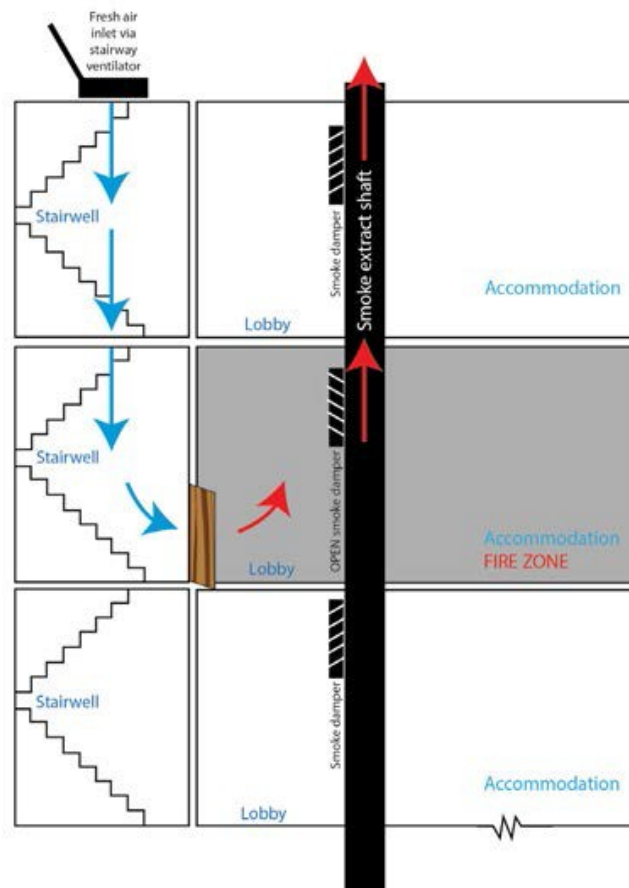



zone to the exterior of the building. Such systems are intended for the timely restoration of operations and overhaul activities once a fire is extinguished. Post-fire smoke purge systems are not intended or designed to be life safety systems. This system is required in all high-rise buildings and other buildings listed in Section BC 912

For the post-fire smoke purge system pursuant to 2008 or 2014 Building Code, a firefighter's smoke control panel for Fire Department emergency response purposes must be provided. The panel must include manual control or override of automatic control for mechanical smoke control systems. The panel must be located in a Fire Command Center complying in high-rise buildings or buildings with smoke-protected assembly seating. The panel must be able to manually activate the post-fire smoke purge system. The post-fire smoke purge system will be under the control of the FDNY only and will enable the FDNY to exhaust the toxic gases from the building.

Post-fire smoke purge systems must be maintained in good working order. A record of inspections and tests must be maintained on the premises or other approved location for a minimum of 3 years.

## **6.5 Emergency power systems and Battery systems**

### **6.5.1 Emergency power systems**

Emergency power systems are intended to provide electrical power for life safety systems where the loss of normal power would endanger occupants. Emergency power systems are required to be provided in all hotels, high-rise office buildings, some assembly occupancies, or office buildings under 75 feet in height that have more than 15,000 sqft. per floor or a total gross area over 100,000 sqft.

NFPA standard 110 recognizes two levels of emergency power systems:

- Level 1 systems shall be installed where failure of the equipment could result in loss of human life or serious injury. Essential electrical systems can provide power for the following essential functions:
  - Life safety illumination
  - Fire detection and alarm systems
  - Elevators
  - Fire pumps
  - Public safety communications systems
  - Industrial processes where current interruption would produce serious life safety or health hazards
  - Essential ventilating and smoke removal systems
- Level 2 systems shall be installed where failure of the equipment is less critical to human life and safety. Level 2 systems typically are installed to serve loads, such as the following, that, when stopped due to any interruption of the primary electrical supply, could create hazards or hamper rescue or fire-fighting operations:
  - Heating and refrigeration systems
  - Communications systems
  - Ventilation and smoke removal systems
  - Sewage disposal
  - Lighting
  - Industrial processes
  -

(1) **Individuals authorized to perform tasks**

Fire Code requires that the inspection, testing and other maintenance of emergency power systems be conducted under the supervision of a person having one of the following qualifications:

- A person holding a Certificate of Fitness as a Fire and Life Safety Director.
- A person holding a Q-01 Certificate of Qualification.
- An electrician licensed by the Department of Buildings.
- An electrician holding a special license issued by the Department of Buildings.
- A person holding a stationary engineer license, or high-pressure boiler operating engineer's license issued by the Department of Buildings.
- A registered design professional.

FLS Director must at least know what type of emergency power systems are installed at his or her premises, the locations of the power source and the location of the control switch for activating the emergency generator.

They also must know what equipment is connected/served by these emergency power systems.

(2) **Periodic inspection and testing requirements**

Fire Code requires that emergency power systems be maintained in accordance with NFPA Standard 110, as modified by FC Appendix B (Emergency and Standby Power Systems) and NFPA Standard 111 (Stored Electrical Energy Emergency and Standby Power Systems). Chapter 8 of NFPA Standard 110 includes requirements for the periodic inspection, testing and other maintenance of emergency power systems supplied by emergency generators. Chapter 6 of NFPA Standard 111 includes requirements of the periodic inspection, testing, and other maintenance of stored emergency power systems. These NFPA standards should be reviewed in their entirety to fully understand the requirements.

Fire Code requires that the inspection, testing and other maintenance of emergency power systems be conducted in accordance with an established schedule. **The following table summarizes the NFPA standards. The information boxed on the following pages may be provided as part of the reference material during the school graduation exam or the FDNY exam.**

FLS Director, must ensure the frequency and the procedures to inspect, test and/or maintain the emergency power system comply with all the requirements.

## NFPA Standard 110

Chapter 8 of NFPA Standard 110 includes requirements for the periodic inspection, testing and other maintenance of emergency power systems supplied by emergency generators. Emergency power systems subject to compliance with the requirements of NFPA Standard 110, as modified by FC Appendix B must be maintained as follows:

- Storage batteries, including electrolyte levels or battery voltage, must be inspected weekly and maintained in full compliance with the manufacturer's specifications. Lead- acid batteries must include the monthly testing and recording of electrolyte specific gravity.
- Emergency power systems, including all related components, must be inspected weekly and exercised under load monthly.
- Emergency generator sets must be tested monthly for a minimum of 30 minutes under operating temperature conditions and at not less than 30 percent of the emergency power system nameplate kilowatt rating, or under loading that maintains the minimum exhaust gas temperatures as recommended by the manufacturer. Instructions must be provided for safe manual transfer in the event automatic transfer switches malfunction
- Diesel-powered emergency power system installations that do not meet the requirements of generator set monthly exercise as noted above must be tested monthly with the available emergency power system load and exercised annually with supplemental loads at 25 percent of nameplate rating for 30 minutes, followed by 50 percent of nameplate rating for 30 minutes, followed by 75 percent of nameplate rating for 60 minutes, for a total of 2 continuous hours.
- Transfer switches must be tested semiannually. The semiannual test of a transfer switch must consist of electrically operating the transfer switch from the standard position to the alternate position and then returning back to the standard position.
- Level 1 emergency power systems must be tested every 3 years for at least 4 hours under their running load. A full facility power outage is not intended for this test, but is recommended where a facility power outage has not occurred within the last 36 months.
- Emergency power systems must be maintained to ensure to a reasonable degree that the system is capable of supplying service within the time specified for both the type and the class. The maintenance procedure and frequency should conform to the manufacturer's recommendations. In the absence of such recommendations, Figure A.8.3.1(a) of NFPA Standard 110 suggests periodic (weekly, monthly, quarterly, semiannually and annually) visual inspection, checking, changing components, cleaning and testing of the following:
  - Fuel.
  - Lubrication system. ○ Cooling system. ○ Exhaust system. ○ Battery system. ○ Electrical system. ○ Prime mover. ○ Generator.
  - General conditions of emergency power systems (any unusual condition of vibration, leakage, noise, temperature or deterioration), and service room or housing housekeeping.
  - Restore systems to automatic operation condition.

## NFPA Standard 111

Stored electrical energy emergency power systems subject to compliance with the requirements of NFPA Standard 111 must be maintained as follows:

- Equipment must be inspected monthly and tested quarterly under connected load for a minimum of 5 minutes. The monthly inspection must include the following:
  - Battery and associated charger/control equipment must be checked to verify that they are in a clean and satisfactory condition.
  - Battery electrolyte levels, individual cell voltages and specific gravity must be checked.
  - Conditions of the plates and sediment of free-electrolyte, lead-acid batteries in transparent containers must be checked.
  - A load test must be performed and the output voltage, the battery voltage, and the duration of the test must be recorded at the beginning and end of the test for each battery set.
  - All indicator lamps, meters, and controls must be checked to verify that they are operating correctly.
- Stored emergency power systems must be checked annually at full load for time duration as specified in NFPA Standard 111.
- Transfer switches must be tested semiannually.
- A regular maintenance and testing program must be established. The maintenance procedure and frequency should conform to the manufacturer's recommendations. In the absence of such recommendations, Table A.8.3.2 of NFPA Standard 111 suggests periodic (weekly, monthly, quarterly, semiannually, and annually) visual inspection, checking, changing components, cleaning and testing of the following:
  - Battery.
  - Energy conversion equipment.
  - Battery charger.
  - Load current (check quarterly).
  - Transfer switch (tested semiannually).

### (3) **Recordkeeping**

A written record of inspection, testing and other maintenance of emergency power systems, including additional description of any conditions requiring correction, and what corrective action was taken, is required to be maintained on the premises. Records are required to be maintained for at least 3 years.

#### **6.5.2 Battery systems**

Battery systems can provide an uninterruptible power supply (UPS) that is capable of providing electrical power to key operating systems in a building. The primary purpose of a UPS system is to provide current to a load for a short period of time to certain building systems in the event of normal power failure. When a building with a "UPS" system suddenly loses power from the utility company the UPS system becomes the sole power provider for all designated connections. The difference is that a UPS battery system switches on instantaneously so that there is no down-time

or absence of power. A building with a UPS system, but no emergency generator, will lack power if the UPS system has fully discharged.

### **Individuals authorized to perform tasks**

Certain battery systems in place today, regardless of installation date, must be under the general supervision of a person holding a B-29 Certificate of Fitness from the FDNY. This applies to all stationary storage battery systems (i.e. facility standby power, emergency power, or uninterrupted power supplies) having an electrolyte capacity of at least:

50 gallons for

- flooded lead acid
- nickel cadmium (Ni-Cd)
- valve-regulated lead acid (VRLA)

1,000 pounds for

- lithium-ion
- lithium metal polymer

In order to ensure that a battery system is properly working, a B-29 Certificate of Fitness holder is primarily responsible for visual inspection. The B-29 Certificate of Fitness does NOT authorize the C of F holder to perform any repairs on the battery system.

Stationary battery system rooms and enclosures must be designed and constructed in accordance with the Building Code. Battery systems may be installed in the same room as the equipment to which they provide power.

## Signage requirements

Signs and instructions should be posted near battery room for personnel, in case of emergency with no trained or designated FLS Director on site. The signage that may be used in battery areas include but are NOT limited to the following:

Any potential hazards, safety precautions or instructions, shutoff switch locations, or other important information is recommended to be posted conspicuously.

A durable sign that reads as follows must be posted on doors into electrical equipment rooms or buildings containing stationary battery systems: "CAUTION: This room contains energized battery systems. Battery electrolyte solutions may be corrosive."

Cabinets must have a sign or marking identifying the type of battery system, the electrical rating (voltage and current) of the system, and applicable chemical and fire hazards.



Examples of cabinet signs would be the following:

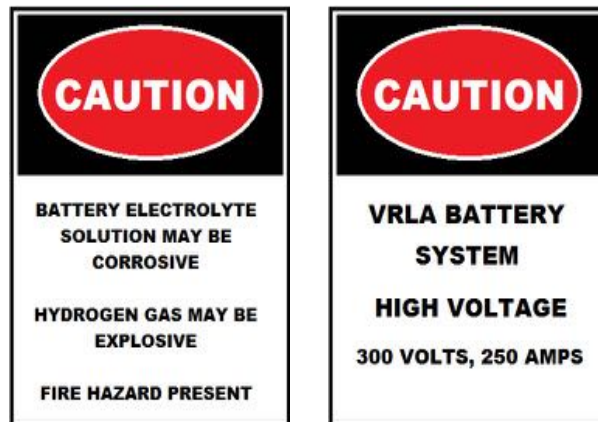

NFPA 704 diamond signs are required to be posted in battery areas with a minimum of 55 gallons of corrosive material. The sulfuric acid specific sign is shown below:

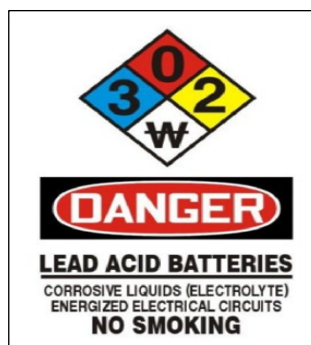

## **Emergency procedures**

Emergency procedures detailing how to shut down the power from the battery system must be posted on or near the battery system or kept in an approved location on the premises. The procedures must also include a 24hour/7-day per week telephone number by which the owner can be contacted to provide additional information to emergency responders.

## **Multi-tenant buildings**

Many buildings in NYC are not occupied by a single tenant and therefore may have more than a single UPS system within the building. Each tenant is responsible for his/her own system, or systems. Typically, one tenant will have a different C of F holder than the next tenant so that tenants and entities can remain independent of one another. This does **not** mean that they cannot share a C of F holder. The building manager is responsible to know the location of all UPS battery systems in their building and know who is responsible for each UPS battery system.

For example, assume one building has 10 tenants occupying at least 10 floors. All of the situations below would be acceptable:

All 10 tenants in the building use the same C of F holder to inspect their systems. (*Very unlikely*)

Eight of the 10 tenants use the same C of F holder for inspections, and the other two each have their own C of F holders.

All 10 tenants in the building have separate C of F holders – meaning 10 different C of F holders are in the building on a daily basis. (*Preferred*)

## **Single tenant buildings**

If there is only one tenant in a building, then typically there will only be one C of F holder for all of the UPS systems occupying the building, whether it is one or 20. Again, this is not required. If the tenant desires 20 different inspectors for the 20 systems, then that is acceptable. The building FLS Director and the building owner should have access to a list of all the battery system C of F holders, their respective contact information, and the exact location of the battery systems that they provided with general supervision.

## **Periodic inspection and testing requirements**

All such visual inspections should be conducted by a B-29 Certificate of Fitness holder to provide general supervision. The B-29 Certificate of Fitness holder should walk through and do a “quick” visual inspection at least once per day.

## **6.6 Refrigerating systems**

### **6.6.1 Introduction**

A refrigerating system is a combination of interconnected refrigerant-containing parts constituting one closed refrigerant circuit in which a refrigerant is circulated for the purpose of extracting heat. Refrigerating systems are most commonly used in buildings for purposes of human comfort. As such, the operation of refrigerating systems is integral with building ventilation systems which have a direct impact on the movement of smoke throughout a building under fire conditions.

### **6.6.2 Permits**

Fire Code requires a permit to maintain or operate a refrigerating system that uses a Group A1, A2, A3, B1, B2, or B3 refrigerant or that is mounted on or suspended from a roof or ceiling. No permit is required for a refrigerating system of less than five horsepower that uses a Group A1 refrigerant and that is not mounted on or suspended from a roof or ceiling. No permit is required

for a refrigerating system installed in the residence portion of any building or employing water or air as a refrigerant.

Additional Equipment Use Permit, other approved documentation, issued by the Department of Buildings for systems mounted on or suspended from a roof or a ceiling may be required. To verify if your system requires an Equipment Use Permit, contact the Department of Buildings via 311 or through the Department of Buildings website.

### **6.6.3 Supervision**

The Fire Code requires that certain refrigerating systems (FC Table 606.1.1) be under the personal supervision of a person holding a Certificate of Qualification as a Refrigerating System Operating Engineer (RSOE). You should refer to FC Table 606.1.1 for detailed requirements.

For those systems requiring personal supervision, at least one RSOE must be present in the building while the system is in operation. "Present in the building" is a critical requirement. On the flip side, if the refrigerating system is shut down, no RSOE is required to be in the building.

### **6.6.4 Periodic inspection, testing, and maintenance requirements**

#### **Operator inspection after repairs**

After any repairs are made to a refrigerating system, the operation of which requires supervision by a certificate of qualification holder, the certificate of qualification holder must check the repairs together with the functioning of all control devices and the positioning of all valves.

### **6.6.5 Recordkeeping**

#### **Operator logbook**

Fire Code requires a logbook for refrigerating systems whose operation requires supervision by a Q-01 certificate of qualification holder. Entries are required to be made in the logbook by the Q-01 certificate of qualification holder. The logbook must include entries of any operating problems or deficiencies, and required periodic tests conducted.

#### **Written records**

Fire Code requires a written record to be kept of refrigerant quantities brought into and removed from the premises. Records of all refrigerating system periodic inspection, testing, and other maintenance required by the Fire Code are required to be maintained on the premises for a minimum of 3 years.



## 6.7 Commercial cooking systems

### 6.7.1 Introduction

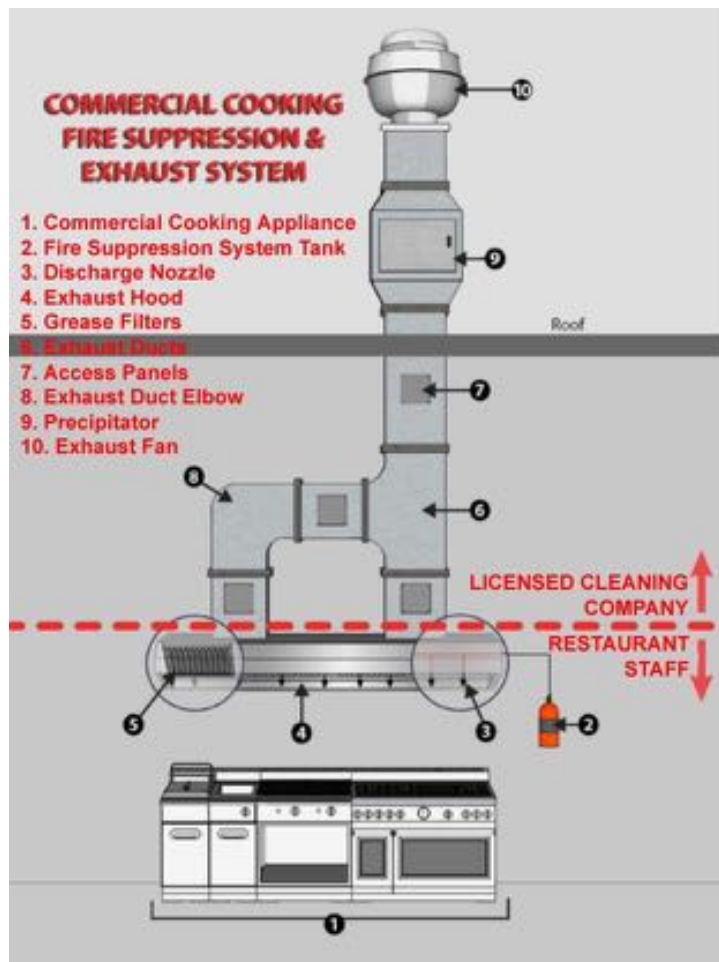

A commercial cooking system is a system that consists of commercial cooking equipment, exhaust hoods, filters, exhaust duct systems, fire extinguishing system and other related components designed to capture grease-laden vapors and exhaust them safely to the outdoors. The requirements as to the type of commercial cooking exhaust hoods required to be installed in connection with the commercial cooking equipment are set forth in the Mechanical Code. An FDNY permit is required to maintain or operate commercial cooking systems.

According to an NFPA report, more than one-third of fires in hotels, office buildings or facilities that care for the sick begin in the kitchen or cooking area. Properly cleaned and maintained commercial cooking facilities and fire extinguishing systems can protect the business, employees, customers and the public from fire damage.

### 6.7.2 Fire safety in commercial cooking facilities

FLS Director, should inform the fire safety regulations to the commercial cooking exhaust system facility owner. The information can be obtained from the FDNY released fire safety education brochure for restaurant or commercial cooking facility owners:

<http://www1.nyc.gov/assets/fdny/downloads/pdf/business/Support/fire-safety-in-commercial-cookinglocations.pdf>

In summary, FLS Director should educate the facility owner:

#### 1. What needs to be cleaned and by who?

The cleaning of the exhaust system ducts and other system components above the hood must be done by an FDNY approved licensed companies and their certified employees (W-64/P-64 C of F). However, grease filters must be inspected and be cleaned by a trained and knowledgeable person (does NOT need to be a Certificate of Fitness holder).

The list of FDNY Certified Companies can be found on the following website: Approved Companies with Electrostatic Precipitators in the exhaust duct:

<http://www1.nyc.gov/assets/fdny/downloads/pdf/business/approved-companies-commercial-cookingprecipitator.pdf>

Approved Companies without Electrostatic Precipitators in the exhaust duct  
<http://www1.nyc.gov/assets/fdny/downloads/pdf/business/approved-companies-commercial-cooking.pdf>

**2. Staff training requirements**

The owner or operator of commercial cooking equipment must train all food service staff in the proper procedure for the use of all components of the grease removal system, cleaning of filters, and the manual operation of the fire extinguishing system. Refresher training in the manual operation of the fire extinguishing system must be provided at least once every 6 months. Records of such training must be maintained on the premises.

**3. How to tell if the service company performed a good cleaning job?**

Because the cleaning is often performed afterhours without the presence of the facility owner, the owner should request the company to provide before and after pictures (see example pictures) with time stamps for proof of work. Insist on getting the proof. Insist on receiving copy of the checklist of work that was done during the cleaning.

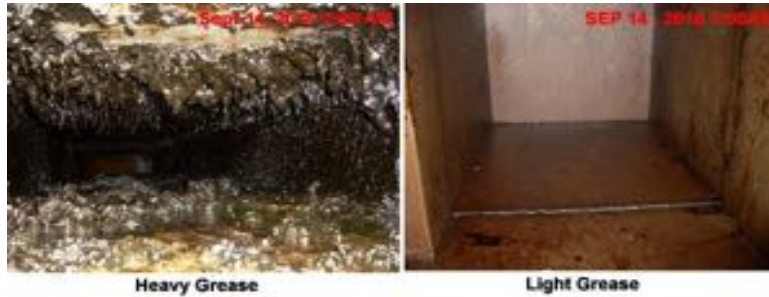

Heavy Grease

Light Grease

**6.7.3 Signs and servicing stickers**

Decals must be attached to each hood after service. The decals are provided by the FDNY approved Commercial Cooking Exhaust Cleaning Companies to show proof of work completed. Old rangehood decals varied in size, shape, color and material which meant they could be easily counterfeited. In addition, they were harder to understand and identify for the FDNY and the public. The new FDNY rangehood decals are standardized, with several new security measures. Only FDNY approved rangehood companies can provide these new decals to businesses. New rangehood decals are easily identifiable by the FDNY and the public.

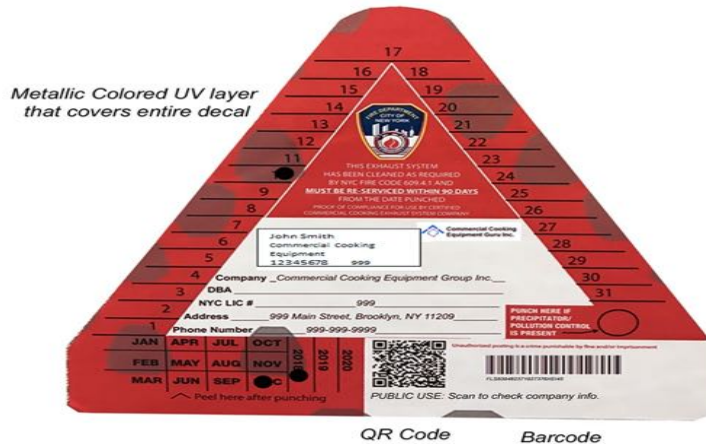

**RANGEHOOD DECAL**

The benefits of these decals are:

- FDNY is able to control decal issuance,
- Consistent decal design (which in turn is easily verified by FDNY and public),
- Each Certificate of Fitness holder will have an identifying stamp (with their full name, COF number and a company logo) and the employees who PERFORMED the work need to use their COF stamp on the tag after performing the work.
- Each decal will have a clear gloss embossed FDNY logo covering the whole decal,
- Decals will be virtually impossible to reproduce and counterfeit.



Starting February 15, 2019, the FDNY will only recognize new rangehood decals and will be issuing violations to businesses that don't have proper service compliance decals.

A placard stating, "the fire extinguishing system must be activated prior to using a portable fire extinguisher." and the instructions for manual operation of the fire extinguishing system must be posted, under glass or laminated, near the system's manual activation device. Information shall be clearly and concisely written.



#### 6.7.4 Recordkeeping

Recordkeeping of all commercial cooking system inspections, tests, servicing, and other maintenance required by the Fire Code, including exhaust system inspection and cleaning, filter cleaning or replacement, semiannual fire extinguishing system inspection, and replacement of deep fat fryer high-limit controls must be maintained on the premises for a minimum of 3 years. **The FLS Director should advise the owner of commercial cooking equipment to have a cleaning company authorized by the FDNY and should keep the name of service company in the FLS logbook.**

## 6.8 Non-water fire extinguishing systems

### 6.8.1 Introduction

Non-water fire extinguishing systems are generally provided in lieu of a required sprinkler system where the nature of the fire hazard is such that water is not effective as an extinguishing agent. The use of a non-water fire extinguishing system must be acceptable to the Fire Department and the Department of Buildings. Non-water fire extinguishing systems include wet chemical, dry chemical, foam, carbon dioxide, Halon, clean agent, and water mist.

### 6.8.2 Individuals authorized to perform tasks

Non-water fire extinguishing systems must be visually inspected monthly by a trained and knowledgeable person to assess whether the system is in good working order. **The FLS Director or the Building Engineer may be designated as the person who is responsible to perform the visual inspection of these systems. All FLS Directors must know what non-water fire extinguishing systems are installed in their premises and the areas that these systems serve.**

A licensed master fire suppression piping contractor properly trained and having knowledge of the installation, operation, and maintenance of the specific non-water fire extinguishing system is required to test, service and otherwise maintain such system semiannually (annually for foam fire extinguishing systems and water mist fire extinguishing systems).

### 6.8.3 Periodic inspection and testing requirements

Non-water fire extinguishing systems must be maintained in good working order at all times. Any fire protection system that is not in good working order must be repaired or replaced as necessary to restore such system to good working order, or, where authorized by the Building Code, removed from the premises.

Fire protection systems must be inspected, tested, serviced and otherwise maintained in accordance with the Fire Code, Fire Rules the referenced standards in the table below. Where required by this section, such inspection, testing, and maintenance must additionally comply with the rules. Where applicable, the requirements of the reference standards listed in the following table must be in addition to those requirements specified in the Fire Rules, NFPA standards, or in the manufacturer's maintenance procedure.

<b>FIRE PROTECTION SYSTEM MAINTENANCE STANDARDS SYSTEM</b>	<b>STANDARD</b>
Dry and wet chemical fire extinguishing systems	NFPA 17 and NFPA 17A
Foam systems	NFPA 11 and NFPA 16
Carbon dioxide fire extinguishing system	NFPA 12
Halon 1301 fire extinguishing systems	NFPA 12A
Clean agent fire extinguishing systems	NFPA 2001 (as modified by FC Appendix B)
Water mist fire extinguishing systems	NFPA 750

**Non-water fire extinguishing systems summary table**

Systems	Commonly found in/with	Monthly visual inspection	Test, service and maintenance	
			Qualified personnel	Minimum frequency requirement
Dry chemical fire extinguishing systems	flammable liquid storage rooms and at motor fuel dispensing areas.	required	A licensed master fire suppression piping contractor properly trained and having knowledge of the installation, operation and maintenance of the specific system.	semiannual
Wet chemical fire extinguishing systems	commercial cooking system	required		semiannual
Foam systems	commercial cooking system, flammable liquid drum storage area, hazardous waste facilities	Required (need to be conducted by a C of F holder)		annual
Carbon dioxide fire extinguishing system	flammable liquid storage rooms and at motor fuel dispensing areas.	required		semiannual
Clean agent fire extinguishing systems	IT systems, data storage rooms and manufacturing equipment, or irreplaceable items	required		semiannual
Halon fire extinguishing systems		required		semiannual
Water mist fire extinguishing systems	computer rooms or other energized electrical equipment areas	required		annual

The information provided on the following pages and boxed “good to know” is for reference purpose and won’t be tested on the FLS Director school graduation exam or the FDNY FLS Director exams. The FLS Director should be familiar with the basic fire safety requirements if there is any such following system installed at the premises.

## **Good to know:**

### **Wet and dry chemical fire extinguishing systems**

- Wet chemical fire extinguishing systems are commonly used with commercial cooking system.
- Dry chemical fire extinguishing systems are commonly installed in flammable liquid storage rooms and at motor fuel dispensing areas.
- Wet and dry chemical fire extinguishing systems are required to be recharged after use or where an inspection or maintenance check indicates the need.
- At least once a month, an inspection must be conducted by a trained and knowledgeable person to assess that the system is in good working order. The monthly inspection, or “quick check” requirement, must verify the following:
  - The system is in its proper location.
  - The manual activation devices are unobstructed.
  - The tamper seals are intact.
  - The semiannual maintenance tag is in place.
  - The system shows no physical damage or condition that may prevent operation.
  - The pressure gauge(s) are in operable range.
  - The nozzle blow-off caps are in place and undamaged.
  - The protected equipment and the hazard have not been replaced, modified, or relocated.
- A licensed master fire suppression piping contractor properly trained and having knowledge of the installation, operation, and maintenance of the wet and dry chemical fire extinguishing system must inspect, test, service, and otherwise maintain such system in accordance with this section and the manufacturer’s specifications and servicing manuals at least on a semiannual basis. Tests must include a check of the detection system, alarms, and releasing devices, including manual stations and other associated equipment. Extinguishing agent containers must be checked to verify that the system has not been discharged. Stored pressure-type units must be checked for the required pressure. The cartridge of cartridge-operated units must be weighed and replaced at intervals specified by the manufacturer.

## **Good to know:**

### **Carbon dioxide fire extinguishing systems**

- Carbon dioxide fire extinguishing systems are commonly installed in large flammable liquid storage areas
- At least once a month, an inspection must be conducted by a trained and knowledgeable person to assess whether the system is in good working order. A monthly update, or “quick check” (as required by FC904.8 and Section A.4.8.1 of NFPA Standard 12) must verify the following:
  - High-pressure cylinders are in place and properly secured.
  - Low-pressure storage unit pressure gauges show normal pressure, that the tank shutoff valve is open, and that the pilot pressure supply valve is open. The liquid level gauge



should be observed. If at any time a container shows a loss of more than 10 %, it should be refilled, unless the minimum gas requirements are still provided.

- Carbon dioxide storage is connected to discharge piping and actuators.
  - All manual activation devices are in place, and tamper seals are in place.
  - Nozzles are connected, properly aligned, and free from obstructions and foreign matters.
  - Detectors are in place and free from foreign matter and obstructions.
  - System control panel is connected and showing “normal-ready” condition.
- A licensed master fire suppression piping contractor properly trained and having knowledge of the installation, operation, and maintenance of the carbon dioxide fire extinguishing system must inspect, test, service, and otherwise maintain such system in accordance with this section and the manufacturer’s specifications and servicing manuals at least on a semiannual basis.
  - Liquid-level gauges of low-pressure carbon dioxide containers are required to be inspected weekly. Containers showing a content loss of more than 10 percent must be refilled.
  - Auxiliary and supplementary components of carbon dioxide fire extinguishing systems, such as switches, door and window releases, interconnected valves, damper releases and supplementary alarms, are required to be manually operated annually to ensure proper operating condition.

**Good to know:**

**Carbon dioxide fire extinguishing systems (continue)**

- Carbon dioxide fire extinguishing system hoses must be examined at 12-month intervals for damage. At 5-year intervals, such hoses are required to be tested by a trained and knowledgeable person.
- Total flooding carbon dioxide fire extinguishing systems must not be installed to protect hazards within normally occupied areas. Previously installed total flooding carbon dioxide fire extinguishing systems installed to protect normally occupied areas were required to be removed by July 1, 2013, and a replacement fire extinguishing system installed.
- Warning signs are required in every protected space, entrance to protected space, nearby protected space, and outside each entrance to rooms containing a carbon dioxide fire extinguishing system. Typical warning signs are as follows:

- In protected space,

**WARNING**

CARBON DIOXIDE GAS

WHEN ALARM ACTIVATES VACATE IMMEDIATELY

- At entrances to protected space,

**WARNING**

CARBON DIOXIDE GAS

WHEN ALARM ACTIVATES DO NOT ENTER UNTIL VENTILATED

- In areas nearby protected space,

**CAUTION**

CARBON DIOXIDE DISCHARGE INTO A NEARBY SPACE CAN COLLECT HERE.  
WHEN ALARM ACTIVATES VACATE IMMEDIATELY

- Outside each entrance to rooms containing a carbon dioxide fire extinguishing system,

**CAUTION**

CARBON DIOXIDE GAS

VENTILATE THE AREA BEFORE ENTERING. A HIGH CARBON DIOXIDE GAS  
CONCENTRATION CAN OCCUR IN THIS AREA CAUSING SUFFOCATION

- Each Manual Actuation Station

**CAUTION**

CARBON DIOXIDE GAS

ACTUATION OF THIS DEVICE CAUSES CARBON DIOXIDE TO DISCHARGE.  
BEFORE ACTUATING, BE SURE PERSONNEL ARE CLEAR FROM THE AREA.

**Good to know:**

**Clean agent fire extinguishing systems**

- Clean agents are electrically non-conductive and non-corrosive, and there should be no damage to electronics and delicate mechanical devices upon system discharge in such areas. Clean agent fire extinguishing systems may be ideal for IT systems, data storage rooms and manufacturing equipment, or irreplaceable items like customer/client records, intellectual property, art, antiques and artifacts.
- At least once a month, an inspection must be conducted by a trained and knowledgeable person to assess whether the system is in good working order. A licensed master fire suppression piping contractor properly trained and having knowledge of the installation, operation, and maintenance of the clean agent fire extinguishing system must inspect, test, service and otherwise maintain such system in accordance with this section and the manufacturer's specifications and servicing manuals at least on a semiannual basis.
- The extinguishing agent quantity and pressure of clean agent containers are required to be checked at 6-month intervals. Where a container shows a loss in original weight of more than 5 percent or a loss in original pressure, adjusted for temperature, of more than 10 percent, the container must be refilled or replaced. The weight and pressure of the container must be recorded on a tag attached to the container.
- Clean agent fire extinguishing system hoses are required to be examined at 12-month intervals for damage. Damaged hoses must be replaced or tested. Clean agent fire extinguishing system hoses are required to be tested at 5-year intervals.
- Enclosures protected by the clean agent fire extinguishing system are required to be thoroughly inspected at least every 12 months to determine if penetrations or other changes have occurred that could adversely affect agent leakage or change volume of hazard or both. Where the inspection indicates conditions that could result in not being able to maintain the clean agent concentration, they must be corrected. If uncertainty still exists, the enclosures are required to be retested for integrity.



**Good to know:**

**Halon Fire Extinguishing Systems**

- Halon (short for halogenated hydrocarbon) is non-conducting and described as a "clean agent," as it leaves no residue after being discharged. Halon fire extinguishing agents, include Halon 1211, Halon 1301, and a combination of the two. Halon 1211 is a "streaming agent," and more commonly used in hand-held extinguishers because it discharges mostly as a liquid stream. Halon 1301 is a "flooding agent," and discharges mostly as a gas, allowing it to penetrate tight spaces and behind obstacles and baffles. This property makes it ideal for use in engine nacelles and other tightly enclosed spaces commonly found in aircraft. Halons have been found to be an ozone-depleting substance, harmful to the Earth's stratospheric ozone layer. As of January 1, 1994, under the Clean Air Act, the United States has banned the production and import of Halons 1211 and 1301.
- At least once a month, an inspection must be conducted by a trained and knowledgeable person to assess whether the system is in good working order. A licensed master fire suppression piping contractor properly trained and having knowledge of the installation, operation, and maintenance of the Halon fire extinguishing system must inspect, test, service and otherwise maintain such system in accordance with this section and the manufacturer's specifications and servicing manuals at least on a semiannual basis.
- The extinguishing agent quantity and pressure of Halon containers are required to be checked at least semiannually. Where a container shows a loss in original weight of more than 5 percent or a loss in original pressure of more than 10 percent, the container must be refilled or replaced. The weight and pressure of the container must be recorded on a tag attached to the container.
- Halon fire extinguishing system hoses are required to be examined at 12-month intervals for damage. At 5-year intervals, Halon fire extinguishing system hoses are required to be tested by a trained and knowledgeable person.
- Auxiliary and supplementary components of Halon fire extinguishing systems, such as switches, door and window releases, interconnected valves, damper releases, and supplementary alarms, are required to be manually operated at 12-month intervals to ensure such components are in proper operating condition.

**Good to know:**

**Water Mist Fire Extinguishing Systems**

- Water mist fire extinguishing systems are commonly found in computer rooms or other energized electrical equipment areas.
- At least once a month, an inspection must be conducted by a trained and knowledgeable person to assess whether the system is in good working order. A licensed master fire suppression piping contractor properly trained and having knowledge of the installation, operation, and maintenance of the water mist fire extinguishing system must inspect, test, service, and otherwise maintain such system in accordance with this section and the manufacturer's specifications and servicing manuals at least on an annual basis. Water mist fire extinguishing systems are required to be flushed annually.
- Water tanks are required to be drained and refilled annually. After system operation, strainers, and filters are required to be cleaned or replaced as required.

**Good to know:**

**Foam fire extinguishing systems**

- At least once a month, an inspection must be conducted by a certificate of fitness holder to assess whether the system is in good working order. A licensed master fire suppression piping contractor properly trained and having knowledge of the installation, operation, and maintenance of the specific fire extinguishing system, must inspect, test, service, and otherwise maintain such system in accordance with this section and the manufacturer's specifications and servicing manuals at least on an annual basis.

***6.8.4 Recordkeeping***

Records of the monthly inspection of all non-water fire extinguishing systems must be maintained on the premises for a period of at least 3 years. Records must include the date the inspection was performed and the initials of the person performing the inspection.

Records of the semiannual inspection of non-water fire extinguishing systems (annual for foam and water mist fire extinguishing systems) by a licensed master fire suppression piping contractor must be maintained on the premises for a period of at least 3 years. Each system must have a tag or label indicating the month and year the maintenance was performed and identifying the individual and contractor performing the service. Only the current tag or label must remain in place.

# Chapter 7. OTHER FIRE SAFETY OPERATIONAL AND MAINTENANCE REQUIREMENTS

## 7.1 Portable fire extinguishers

FLS Directors and all FLS staff must be familiar with the different types of portable fire extinguishers (PFE's). FLS Directors and all FLS staff should know how to operate the extinguishers in a safe and efficient manner.

They must know the difference between the various types of extinguishers and when they should be used. Portable fire extinguishers weighing 40 lbs. or less must be installed so that the top of the extinguisher is not more than 5 ft. above the floor. Hand-held portable fire extinguishers weighing more than 40 lbs. must be installed so that the top of the extinguisher is not more than 3.5 feet above the floor. The clearance between the bottom of the extinguisher and the floor must not be less than 4 inches. In other words, **no fire extinguisher is allowed to be on the floor.**



Fire extinguishers must be located in conspicuous locations where they will be readily accessible and immediately available for use. These locations must be along normal paths of travel.

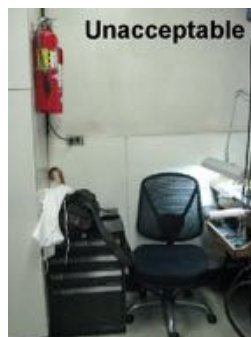



- For the fire extinguisher having 40 pounds or less, its top must not be more than 5 ft. above the floor.
- The fire extinguishers must be accessible and unobstructed.
- The bottom of the fire extinguisher must be at least 4 in. above the floor.
- The fire extinguisher must be properly mounted.

In the event that a fire extinguisher has been discharged, it must be fully recharged or replaced prior to being used again. Portable fire extinguishers are important in preventing a small fire from growing into a catastrophic fire; however, they are not intended to fight large or spreading fires. Portable fire extinguishers should only be used when there is an available means of egress that is clear of fire. By the time the fire has spread, fire extinguishers, even if used properly, will not be adequate to extinguish the fire. Such fires should be extinguished by the building fire extinguishing systems or **trained firefighters only**.











In case of any fire, 911 must be called. Fire extinguishers must be used in accordance with the instructions painted on the side of the extinguisher. They clearly describe how to use the extinguisher in case of an emergency. The FLS Director should be familiar with the use of portable fire extinguishers. When it comes to using a fire-extinguisher, remembering the acronym **P.A.S.S.** help to make sure it is used properly.

**P.A.S.S.** stands for **P**ull, **A**im, **S**queeze, **S**weep. The FLS Director must also train the FLS brigade members and ensure they know how to use portable fire extinguishers.

	
<p><b>A small-in-size fire that may be extinguished by a portable fire extinguisher</b></p>	<p><b>The fire has spread, portable fire extinguisher is NOT enough.</b></p>

### **7.1.1 Different Types of Portable Fire Extinguishers**

Fire extinguishers are classified by the type of fire that they will extinguish. Some fire extinguishers can only be used on certain types of fires, while other fire extinguishers are made to extinguish more than one type of fire. The portable fire extinguisher classification is indicated on the right side of the extinguisher. For more detailed information regarding the different portable fire extinguisher classifications and the types of fires they extinguish, reference the chart below.

Class of Fire	Type of Fire	Type of Extinguisher	Extinguisher Identification	Symbol
<b>A</b>	Ordinary combustibles: wood, paper, rubber, fabrics, and many plastics	Water, Dry Powder, Halon		
<b>B</b>	Flammable Liquids and Gases: gasoline, oils, paint, lacquer, and tar	Carbon Dioxide, Dry Powder Halon		
<b>C</b>	Fires involving Live Electrical Equipment	Carbon Dioxide, Dry Powder Halon		
<b>D</b>	Combustible Metals or Combustible Metal Alloys	Special Agents		No Picture Symbol 
<b>K</b>	Fires in Cooking Appliances that involve Combustible Cooking Media: Vegetable or Animal Oils and Fats			

The most commonly sold portable fire extinguishers are labeled ABC extinguishers. Class ABC extinguishers are often the primary portable fire extinguishers in offices, hotels, theaters, and classrooms. Class ABC extinguishers are dry chemical extinguishers that can be used to extinguish regular combustible fires, flammable liquid fires, and fires involving electrical equipment. ABC extinguishers are usually red in color and range in size from 5-20 lbs. The pictures below show an example of a Class ABC portable fire extinguisher.



Class A portable fire extinguishers are available but are not as prevalent as Class ABC extinguishers. Class A portable fire extinguishers are also known as Air Pressurized Water (APW) fire extinguishers. Water is an extinguishing agent for regular combustibles.

These extinguishers are usually silver in color and approximately 3 feet in height and weight approximately 25 lbs. Class A portable fire extinguishers are useful in buildings and occupancies that primarily contain Type A combustible materials. When an occupancy is classified as a low hazards occupancy (e.g. where the quantity and combustibility of Class A combustible materials is moderate), at least one 2-A fire extinguisher (i.e. 2.5 gallon water extinguisher) is required every 3,000 square feet. These PFEs should ONLY be used on ordinary combustible fires.

The picture to the right shows an example of a typical Class A portable fire extinguisher.





Portable fire extinguishers with a classification of “BC” are used to extinguish flammable liquid fires and electrical equipment fires. Portable fire extinguishers with a classification of just “B” or a classification of just “C” do not exist. “BC” portable fire extinguishers are red in color and range in size from five 5-100 lbs. or larger. Carbon Dioxide portable extinguisher is one common Class BC portable fire extinguishers. An example of a BC portable fire extinguisher is shown in the picture.

As mentioned above, a portable fire extinguisher with just a “C” classification does not exist. The “C” classification indicates ONLY that the extinguishing agent is a nonconductor and is safe to use on live electrical fires. “C” fires will have either an “A” component, such as ordinary combustibles around the

electrical item, or a “B” component such as an oil filled transformer or some electrical device involving flammable liquids. This is the reason “C” classifications are only attached to either a “B” or “AB” fire extinguisher. This classification specifies the fire extinguisher that is most appropriate for extinguishing the fire.

Class K portable fire extinguishers are often found in kitchens and are used to extinguish combustible cooking fluids such as oils and fats. There are different extinguishing agents found in fire extinguishers labeled Class K. Some of these extinguishing agents are dry and some are wet. Potassium bicarbonate is used in some dry chemical fire extinguishers, and a chemical mist is used in some wet chemical fire extinguishers. The extinguishing agents in a Class K fire extinguisher are sometimes electrically conductive and should only be used AFTER the power has been turned off in the electrical appliance. An example of a Class K fire extinguisher is shown in the pictures below:





	Suitable for Class B and Class C fires but not Class A
	Suitable for Class A fires but not Class B or Class C
	Suitable for Class A and Class B fires but not Class C

Portable fire extinguishers are labeled so users can quickly identify the classes of fire on which the extinguisher will be effective. The marking system combines pictures of both recommended and unacceptable extinguisher types on a single identification label. The left chart is an example of typical labels.

**7.1.2 Portable fire extinguisher tags, inspection and servicing**

**(1) Portable fire extinguisher (PFE) tags**

Installed portable fire extinguishers must have an FDNY standard PFE tag affixed. This tag will have important information about the extinguisher. New standard PFE tags (as the following image) will begin appearing at premises starting in November 2018. By November 15, 2019, all portable fire extinguishers must have the new PFE tags. The FDNY will only recognize new PFE tags and will be issuing violations to business that have PFE installed without a proper tag.

A real hologram strip shown on the tag is 3 inches long by ¼ inch wide. Counterfeit tags will NOT have a high quality silver hologram. The hologram on a counterfeit tag will NOT change color as it is moved against the light.

If your PFE tags look different than the one pictured above, contact your supervisor. If you suspect your PFE is a counterfeit, contact FDNY immediately by e-mail:

[Tags.Decal@fdny.nyc.gov](mailto:Tags.Decal@fdny.nyc.gov)



**DO NOT REMOVE BY ORDER OF THE**

- ABC (Dry Chem)
- AFFF/FFFP
- BC (Dry Chem)
- PURPLE K (PK)
- CARBON DIOXIDE
- CLASS D (Dry Powder)
- CLASS K
- FE-36
- FM 200
- HALON 1211
- HALON 1301

**COF STAMP:**  
Stamped information of Certificate of Fitness holder who performed the work.

WATER	•
LOADED STREAM	•
WET CHEM	•
CLEAN AGENT	•
INTERGEN	•

**HOLOGRAM:**  
Real FFE tags will have high quality silver hologram measuring 3 inches long by 1/4 inch high.

**QR CODE:**  
Scan this QR Code to view FDNY approved company PFE list.

**MONTHLY INSPECTION RECORD**

DATE	BY	DATE	BY
12/1/2018	J.L.		
1/1/2019	J.L.		

**PROOF OF COMPLIANCE PER USE PORTABLE FIRE EXTINGUISHER SER**

**VOID 1 YR. FROM MONTH PUNCHED**

SERVICED		NEW	RECHARGED	
NOV	DEC		JAN	FEB
FEB	MAR		MAR	APR
MAY	JUN		MAY	JUN
JUL	AUG		JUL	AUG
SEP	OCT		SEP	OCT
NOV	DEC		NOV	DEC

**2018**  **2019**  **2020**

**Extinguisher Equipment Guru, Inc.**

**WU-387294**

123 Flatbush Ave, Brooklyn

**NAME:** John Smith **EXTINGUISHER EQUIPMENT GURU, INC.**

**COF#:** 12345678 **999**

**COMPANY:** Extinguisher Equipment Guru, Inc.

**ADDRESS:** 12 Oliver Street, Bronx, NY

**PHONE:** 999-999-9999



## (2) Inspections and servicing

### MONTHLY INSPECTION

The portable fire extinguishers are required to be checked monthly. The owner of the business is responsible to select a person to do a monthly inspection. This monthly inspection is called a "quick check".

The QUICK CHECK should check if:

- the fire extinguisher is fully charged;
- it is in its designated place;
- it has not been actuated or tampered with;
- there is no obvious or physical damage or condition to prevent its operation.

The information of the monthly inspection record must include the date of the inspection, the name/initials of the person who did the inspection. This monthly quick check is documented on the back of the PFE tag or by an approved electronic method that provides a permanent record.



### ANNUALLY SERVICING

At least annually all Portable Fire Extinguishers must be serviced by a W-96 Certificate of Fitness holder from FDNY approved company.

#### **7.1.3 Portable fire extinguisher annual servicing**

Servicing is a thorough examination of the portable fire extinguisher. It is intended to give maximum assurance that the portable fire extinguisher will operate effectively and safely. It also includes any necessary repair or replacement. Servicing the portable fire extinguisher will reveal if hydrostatic testing or internal maintenance is needed. Portable fire extinguishers must be serviced **at least annually** or at the time of hydrostatic testing, or when physical damage to the cylinder is visible during a monthly inspection. Portable fire extinguishers removed for servicing must be replaced by a similar PFE and must be of at least equal rating. The annual servicing must be performed by one of the FDNY approved companies for servicing portable fire extinguishers:

<http://www1.nyc.gov/assets/fdny/downloads/pdf/business/approved-companies-full-service-portable-fireextinguisher.pdf>

**A W-96 Certificate of Fitness holder employed by an FDNY approved company is required to service, maintain, and/or recharge** a portable fire extinguisher. FLS Directors are responsible for making arrangements to have all the extinguishers serviced by a qualified Certificate of Fitness

holder (W-96) and by an FDNY approved company. After each annual inspection W-96 COF holder will replace the PFE tag. The information of the annual inspection record must be indicated on the new PFE tag.

An FDNY released fire extinguisher brochure is available on the following website:

<http://www1.nyc.gov/assets/fdny/downloads/pdf/business/Support/portable-fire-extinguishers-in-yourbusiness.pdf>

## **7.2 Hot work operations**

### **7.2.1 Introduction**

Hot work operations and the equipment and materials associated with such operations represent a significant fire hazard. Hot work creates sparks, slag and heat. Materials such as acetylene, LPG, and oxygen are used in gas welding and torch operations. Electric current is used in arc welding. Hot work is often conducted in buildings that were not designed for these materials and hazards, including buildings undergoing renovation or repairs.

An important factor in avoiding ignition hazards is preparing for and monitoring hot-work operations.

### **7.2.2 Permit and supervision**

#### **Certificate of Fitness**

- Certificate of Fitness (G-60) is needed for conducting any of the following torch operations:
  - An oxygen-fuel torch using any amount of oxygen and flammable gas
  - Any torch operation for torch-applied roof system
- Certificate of Fitness (F-60) holder must be present to perform fire watch during hot work operations at the following locations:
  - Construction sites;
  - Rooftop operations and in conjunction with torch-applied roof system operation;
  - In any building or structure when the torch operation is conducted by a person holding an FDNY permit for torch operation.

#### **Permit**

An FDNY permit is required to conduct hot work using oxygen and a flammable gas.

#### **Hot work program responsible person**

Whenever hot work is performed in any building or structure, on a building roof, or on a building setback, the owner must ensure that such work is performed in accordance with the Fire Code and must designate a responsible person (e.g. FLS Director) to ensure compliance.

The responsible person must ensure that a permit has been obtained from the Fire Department when one is required and ensure that the hot work is performed in compliance with the terms and conditions of the permit. The responsible person must inspect the hot work site prior to issuing a hot work program authorization and periodically monitor the work as it is being performed to ensure there are no fire safety hazards.

Hot work operations must be conducted under the general supervision of the responsible person. The responsible person must maintain “pre-work check” reports.

### **7.2.3 Operational requirements**

#### **Authorized work areas**

Hot work must be performed:

- in areas designated for hot work operations, or
- areas authorized by the responsible person.

Hot work must not be performed:

- in areas where the sprinkler protection is impaired.
- in areas where ignitable vapors are present.
- in areas where readily ignitable material is present.

Hot work operations involving cutting or welding must be conducted at least 35 feet from combustible materials and combustible waste or must be provided with appropriate shielding to prevent sparks, slag, or heat from igniting exposed combustibles. All other hot work operations must be conducted at least 25 feet from combustible materials and combustible waste or must be provided with appropriate shielding to prevent sparks, slag, or heat from igniting exposed combustibles.

#### **Hot work program authorization**

- A hot work program authorization bearing the signature of the responsible person must be obtained for any project conducted on a premises involving hot work operations by the person in charge of such hot work operations. Hot work authorizations, issued by the responsible person, must be available for inspection by any representative of the department during the performance of the work and for 48 hours after the work is complete.
- The hot work authorization must be posted at the work site prior to commencing such work.

#### **Pre-hot work check**

Before hot work is authorized and at least once per day while the authorization is in effect, the hot work area must be inspected by the responsible person to ensure that it is a fire safe area.

A pre-hot work check must be conducted by the responsible person prior to work to ensure that all equipment is safe and hazards are recognized and protected. A report of the check must be kept at the work site during the work and for a minimum of 48 hours after work is completed and made available for inspection by any representative of the department. The pre-hot work check must be conducted at least once per day and must verify the following:

- The hot work equipment is in good working order.
- The hot work area is clear of combustibles and flammable solids or that such materials present in the area are protected in accordance with Fire Code.
- Exposed construction is of noncombustible materials or, if combustible, is protected.
- Openings are protected.
- Hot work area floors are clear of combustible waste accumulation.
- Fire watch personnel, where required, are assigned.
- Approved actions have been taken to prevent accidental activation of fire extinguishing systems and detection equipment. **Sprinkler system protection must not be shut off or impaired while hot work is performed unless approved by the commissioner.** Where

hot work is performed close to sprinklers, noncombustible barriers or damp cloth guards must shield the individual sprinkler heads and must be removed when the work is completed. If the work extends over several days, **the shields must be removed at the end of each workday.**

- Approved precautionary measures must be taken to avoid accidental operation of automatic fire detection systems during hot work operations. For example, the fire alarm system (e.g. smoke detectors) may need to be taken off-line during the hot work operation to avoid unwarranted alarms. The date and time the alarm system was taken off-line, the reason for such action, the name and operator number of the person notified at the central station (or other evidence of notification satisfactory to the Department), and the date and time the system was restored to service must be entered in the alarm log book in each such circumstance.
- Portable fire extinguishers and fire hoses (where provided) are operable and available.
- All persons performing hot work possess certificates of fitness, where such certificates are required.
- All persons performing hot work requiring a permit possess a site-specific permit or citywide permit authorizing such work.

### **Fire watch**

A fire watch must be maintained and fire guards provided in accordance with Fire Code. A fire watch must be maintained during ALL hot work operations. The fire watch must continue for a minimum of 30 minutes after the conclusion of the work. The commissioner, or the responsible person implementing a hot work program may extend the duration of the fire watch based on the hazards or work being performed.

The fire watch must observe the entire hot work area. Hot work conducted in areas with vertical or horizontal fire exposures that are not observable by a single individual must have additional personnel assigned to ensure that exposed areas are monitored.

Persons conducting a fire watch must keep constant watch for fires with respect to the areas being monitored in connection with hot work operations. **The persons conducting a fire watch must not have other duties.**

Where hose lines are required, they must be connected, charged, and ready for operation. A minimum of one portable fire extinguisher complying with the requirements of Fire Code and with a minimum 2-A:20-B:C rating must be provided and readily accessible within a 30 feet travel distance of the location where hot work is performed and where the fire guards are positioned.

**The fire watch for torch operations conducted at the following locations must be conducted by F-60 fire guards:**

- **Construction sites**

An F-60 fire guard must be provided for each torch in operation at construction sites, except that a single fire guard may be designated to conduct a fire watch for more than one torch operation on the same floor or level if each torch operation is not more than 50 feet from the fire guard, as measured by the actual path of travel, and the field of view of such fire guard encompasses all of the horizontal fire exposures of such torch operations.

- **In any building or structure, when the torch operation is conducted by a person holding a citywide permit for torch operations.**

▪ **On any rooftop or in connection with any torch-applied roofing system operation.**

If the torch operation is being conducted at or near the edge of an unenclosed floor of a building, or near a floor opening or other location where sparks and slag may travel to one or more lower floors or levels, a fire guard must conduct a fire watch on each lower floor or level containing combustible surfaces or materials within 35 feet of the area of such floor or level that potentially would be exposed to such sparks or slag. Prior to commencement of the torch operation, the fire safety manager or responsible person must inspect the lower floors or levels and take all necessary and appropriate precautions to protect any combustible surfaces and materials that potentially would be exposed to sparks and slag from the torch operation. A certification to that effect must be made on the hot work authorization.

**Exception:**

1. A fire watch is not required on the floors or levels below a torch operation on a construction site when:
  - 1.1. the torch operation is not being conducted at or near the edge of an unenclosed floor of a building;
  - 1.2. the floor upon which the torch operation is being conducted is of noncombustible construction;
  - 1.3. there are no floor or exterior building openings within 35 feet of the torch operation; and
  - 1.4. prior to commencement of the torch operation, the fire safety manager or responsible person conducts an inspection and takes the precautions required pursuant to Fire Code.
2. Notwithstanding the foregoing exception, if sparks or slag generated by the torch operation are observed to extend beyond 35 feet, thereby potentially exposing lower floors or levels, the torch operation must be immediately discontinued, and the floors or levels below must be inspected for any fire condition. If there is any potential exposure surfaces or materials on the floors below from such sparks and slag, noncombustible barriers must be provided and any other necessary or appropriate precautions must be taken. If such barriers and precautions fail to block the passage of sparks and slag, a fire watch must be established on the floors or levels below.

**It is important to understand the code-required distinction between a fire watch and a fire guard. Not all individuals responsible to maintain a fire watch must possess an F-60**

**7.2.4 Recordkeeping**

The responsible person for the hot work area must maintain “pre-hot work check” reports in accordance with

Fire Code. These reports must be maintained on the premises for a minimum of 48 hours after work is complete.

Hot work authorizations must be available for inspection during the performance of the work and for 48 hours after the work is complete.

**7.3 Flame-resistant decorations**

**7.3.1 Introduction**

The requirements for flame-resistant decorations are intended to limit flame spread that can transform a small fire into a major conflagration. Rapid flame spread was responsible for fires in

places of assembly and other public gathering places that resulted in large loss of life, such as the Cocoanut Grove nightclub fire that killed 492 people in 1942. This fire was thought to have started when a lightbulb in the basement cocktail lounge came in contact with the cotton cloth that had been applied to the ceiling for decorative purposes. Post-fire testing of the cotton cloth indicated that it had a flame spread rating of 2,500, more than 33 times the maximum flame spread in today's standards. This factor, in addition to impediments to egress, led to one of the worst fire disasters in history. The need for these regulations was demonstrated again with the February 2003 Station Nightclub fire in West Warwick, Rhode Island, in which 100 people died. The soundproofing material in the nightclub was not approved for such use and was a major factor in fire spread.

In addition to flame spread ratings of surface materials, certain furnishing types and vegetation, such as Christmas trees, pose a large fire hazard because of the potential fire size and intensity. The materials used in furnishings have changed dramatically from those used in the past and many more plastics are now used for decoration and furnishings. Plastics not only burn more vigorously than materials such as cotton and wood but also produce more toxic fire effluents.

The overall purpose of fire-resistant materials is to ensure that decorations, furnishings, and vegetation do not significantly create or add to fire hazards within buildings. The provisions focus on occupancies with specific risk characteristics, such as vulnerability of occupants, density of occupants, and lack of familiarity with the building.

### ***7.3.2 Operational requirements***

#### **Supervision**

Flame-retardant treatment of a material or item must be conducted under the personal supervision of a C-15 Certificate of Fitness holder.

#### **Occupancies requiring flame-resistant decorations**

In Group A, E, I and M occupancies, common areas in Group R-1 (e.g. Hotels), R-2, and B (e.g. office) occupancies, and any building or structure used as a place for public gathering, curtains, draperies, hangings and decorations are required to be made of a flame resistant material or be treated to be made flame resistant. This does not apply to decorations being displayed solely for sale in any building or as a work of art in any museum or art gallery; to guest rooms in hotels and motels, private offices in commercial buildings; or to houses of worship.

#### **Documentation of flame-resistant materials**

R805-01 sets forth the standards, requirements and procedures for the testing and certification of flame-resistant decorations. Decorations required to be of a flame-resistant material that are installed or maintained in any premises must not be installed or maintained until the owner first files an affidavit of flame resistance for such decorations with the Fire Department. The affidavit must be executed by a C-15 Certificate of Fitness holder, and must indicate that the material is inherently flame-resistant, or that he or she personally supervised the flame-retardant treatment of the material.

#### **Display of natural trees**

Cut natural trees may be displayed in a building, except in Group A, B, E, I-1, I-2, I-3, I-4, M, R-1, and R-2 occupancies and any building or structure used for a public gathering. Notwithstanding the foregoing occupancy restrictions, cut natural trees may be displayed in houses of worship and dwelling units in Group R-2 apartment house occupancies.

Natural trees, except conifers, may be stored and displayed in a building provided they are maintained in a healthy condition and are not allowed to become dry. It is unlawful to store or display natural trees that are conifers in any building.

### **Display of natural decorative greens**

Natural decorative greens may be displayed in buildings on a temporary basis. The display of natural decorative greens in Group A, E, I, and M occupancies, in common areas of Group R-1, R-2, and B occupancies, and any building or structure used for a public gathering, except display of works of art in museums and houses of worship, must comply with the restrictions set forth in FC804.5.3.

## **7.4 Portable fueled equipment**

Portable fueled equipment, including snow blowers, portable generators, power washers, weed trimmers, and lawn mowers, must not be used indoors. Portable fueled equipment must be stored outdoors unless stored in an FDNY approved indoor storage area.

If stored indoors, portable fueled equipment and fuel used in such equipment should not be stored below grade. Such fuel must be stored in an FDNY approved area, in a flammable liquid storage cabinet (if more than two and one half gallons of gasoline are stored), and in quantities that do not exceed amounts that are incidental to and reasonably necessary for the use of such equipment.

## **7.5 Fumigation and insecticidal fogging operations**

### ***7.5.1 Introduction***

Fumigation and insecticidal fogging operation are methods of pest control to suffocate or poison the pests within. They could be used to control pests in buildings. They are hazardous operations because the chemicals used are toxic to most forms of life, including humans. Improper operation may cause injuries, fire, or explosions. Fumigation and insecticidal fogging operations within buildings and structures must be conducted in accordance with the Fire Code. A proper notification must give the location of the enclosed space to be fumigated or fogged.

### ***7.5.2 Companies and individual certifications***

Fumigation and insecticidal fogging operations must be conducted by or under the personal supervision of a person holding a W-97 Certificate of Fitness. This person must be an employee of an FDNY Certified fumigation and insecticidal fogging operation company. The list of FDNY certified company could be found in the following website, the list is updated on a monthly basis: <http://www1.nyc.gov/assets/fdny/downloads/pdf/business/approved-companies-fumigators.pdf>

### ***7.5.3 Operational requirements***

#### **Fire suppression systems**

Fumigation and insecticidal fogging operations must require that fire alarm systems be taken out of service during such operation to avoid unwarranted alarms. The date and time the alarm system was taken off-line, the reason for such action, the name and operator number of the person notified at the central station (or other evidence of notification satisfactory to the Fire Department), and the date and time the system was restored to service, must be entered in the alarm log book in each such circumstance.

#### **Notification**

The Fire Department shall be notified in writing at least 48 hours in advance to the Complaint Desk by emailing [FPCU@fdny.nyc.gov](mailto:FPCU@fdny.nyc.gov). Notification shall give the location of the enclosed space to be fumigated or fogged, the occupancy, the fumigants or insecticides to be utilized, the person or

persons responsible for the operation, and the date and time at which the operation will begin. Cold ULV fogging does not require any notification. Written notice of any fumigation operation shall be given to all affected occupants of the building, structure, or portion thereof in which such operations are to be conducted, with sufficient advance notice to allow all such spaces to be vacated in an orderly manner. Such notice shall inform the occupants as to the purposes and anticipated duration of the fumigation operations.

## 7.6 Rooftop requirements

### 7.6.1 Rooftop gardens and landscaping

Rooftop gardens and landscaping must be maintained in a healthy condition and must not be allowed to encroach upon areas required to be kept clear. Vegetation must be regularly pruned for these purposes and vegetation capable of being ignited must be regularly cleared and removed from the rooftop and the building. Portable fueled equipment, including flammable and combustible liquid fuels, used for the maintenance of rooftop garden and landscaping vegetation must be stored in accordance with the Fire Code requirements.

Rooftop gardens or landscaping exceeding 250 square feet must be provided with a rooftop garden hose connected to an approved water supply. Where the size of the rooftop garden, extent of landscaping, type of vegetation, and/or premises maintenance history warrant, the FDNY may require installation of an irrigation system or other approved method of hydration to ensure proper maintenance of the vegetation.

### 7.6.2 Rooftop overcrowding

An overcrowding condition exists at a rooftop place of assembly or place of public gathering when the number of occupants present in any such place exceeds one person per 10 square feet of the rooftop area to be used for public gathering. For example, more than 120 people gathered in a 1,200 square feet area will be an overcrowding condition.

## 7.7 Certificate of Fitness, FDNY Permit, company certification, and Certificate of Qualification requirements

### 7.7.1 Certificate of Fitness (C of F)

A Certificate of Fitness (C of F) is a certification issued by the New York City Fire Department. These certificates are legally required for individuals conducting certain activities. The goal of the C of F program is to be sure that workers responsible for certain operations or activities are qualified in the performance of their duties. The C of F program is instrumental in preventing fires by helping to ensure that workers understand the safety hazards associated with the duties they perform.



Most certificates are valid for 3 years. Renewals can be completed online, by mail, or in person. The majority of renewals cost \$15. Depending on the type of certificate, an exam may be required as a condition of the renewal. Lost certificates cost \$5 to replace. If you need to change any information



on the certificate, including mailing address, name (legal papers needed) or work location (you will need a letter from your employer and may need to take a new exam), the fee is \$5.

**7.7.2 Fire Code requirements for specific materials, operations and facilities**

Certain materials, operations and facilities require a company certificate to conduct, an FDNY operating permit and/or are required to be under the supervision of a Certificate of Fitness holder or certificate of qualification holder.

The following table outlines the Certificate of Fitness, certificate of qualification, FDNY permit, and Company Certification requirements for specific regulated materials, operations and facilities:

Topics	Required C of F or C of Q	Required Company Certification	FDNY Permit Required
Sprinkler system	S-12/S-15	No	No
Standpipe system	S-13/S-14	No	No
Fire Alarm system	S-95/FLSD: Visual inspection	No	No
	S-78/F-78: inspection & cleaning of smoke detectors	Smoke detector company	
	S-97/S-98: install, repair, service fire alarm system	Smoke detector company or Central station company	
Fire guard for out-of-service fire protection system	F-01	No	No
Fire and Non-Fire Emergency Drill Conductor	W-07(citywide) or F-07 (premises related)	No	No
Refrigerating system	Q-01	No	Yes
Emergency power system	Q-01 , FLSD , other licensed professionals (refer to Section 6.5.1 of this booklet)	No	Yes*
Battery system	B-29	No	No
Elevators-in-readiness	No	No	No
Non-water fire extinguishing systems	S-15 (for foam system)	No	No
Means of egress	No	No	No
Commercial cooking system	P-64/F-64/W-64	Commercial Cooking Exhaust System	Yes
Hot work operations	G-60: Torch operation F-60: Fire guard for torch operation	No	Yes

Flame-retardant treatment	C-15	No	No
Fumigation and insecticidal fogging operation	W-97	Fumigation and Thermal Insecticidal Fogging Operation	No
Storage, use & display of decorations	No	No	No
Emergency planning & preparedness	F-89/T-89	No	No
Portable fire extinguishers	W-96	Portable Fire Extinguisher Servicing	No

\*emergency power system operating on fuel oil requires an FDNY permit for oil storage.

### Permits

FC105.6 lists all permits required for materials, operations, and facilities regulated by the Fire Code. The following permits are commonly issued to building owners:

- Commercial cooking systems
- Compressed gases
- Flammable and combustible liquids
- Hot work operations
- Liquefied petroleum gases (LPG)
- Fuel oil storage
- Open flames (Places of assembly)
- Places of assembly
- Refrigerating systems

### 7.7.3 Certificate of Fitness (C of F) exam information

#### Study materials

The FDNY provides examination study material free of charge to help applicants prepare for most exams. Exam questions are taken directly from the study material. Study material is available online at <http://www1.nyc.gov/site/fdny/business/all-certifications/all-certifications.page>. Exam study materials can be picked up from FDNY Headquarters or by calling 718-999-1988.

The FDNY does not offer classes or training to prepare candidates for the Certificate of Fitness/Certificate of Qualification exams. There are a few exams (e.g. FLS Director) where applicants are required to attend an FDNY approved training school. Most exams do not require this. Check the notice of examination for each certificate for detailed information of any required training or experience for the certificate.

## Computer-based exam

- What is the exam like?

Exams are administered on a “touch screen” computer based and multiple choice. Exams are administered in English. Applicants are permitted to bring a dictionary (paper copy only) to assist them in the exam. **No other outside papers, books, or electronic devices may be used during the test.**

- What do I need to enter the testing location?

Government issued photo ID is required to enter the building (examples: non-driver’s license, driver’s license, passport, or an IDNYC Municipal ID Card.)

- When can I take a test? Should I schedule an exam?

Walk-in exams are given Monday thru Friday 8 a.m. – 2:30 p.m. No tests will begin after 2:30 P.M. unless an appointment is scheduled. FLS Director computer based exams require an appointment. Please visit: <http://www1.nyc.gov/site/fdny/business/all-certifications/cof-online-scheduler.page> for more information on scheduling.

- What happens when I arrive at the testing location?

Upon entering FDNY Headquarters, all visitors and their belongings are screened. Weapons, tools and metal



utensils are **not allowed** in the FDNY Headquarters:

- How long will I be there?

It depends on the exam and how many exams you are taking that day (max of 2 allowed). You should plan on at least 2-3 hours.

- When will I get my results?

You will obtain your results immediately upon completion of the exam. If you pass the exam, the certificate or letter of having passed the exam will be issued to you before you leave.

- What if I fail? You will be given a failure report and a receipt before you leave.

- Can I retake the test? If so, when?

Yes. Generally, you can retake an exam the next business day.

- Is there a fee to retake an exam?

Yes. You will be required to pay the original application fee of \$25 to retake an exam.

### 7.7.4 Fraudulent activity regarding certificates

All Certificates of Fitness and Certificates of Qualification are issued by the Fire Department. It is a credit-card size card that includes a photo ID. Certificates of Fitness and Certificates of Qualification are only issued by the Certificate of Fitness Unit of Fire Department at 9 Metrotech Center, Brooklyn. It is illegal for anyone to offer you a certificate without you having to go to the Fire Department to take a test. Both the person accepting the certificate and the person offering the certificate are breaking the law. It is also illegal to allow another person to take the examination for you. If you suspect a fraudulent certificate or other fraudulent activity regarding Fire Department certificates, you should contact the Bureau of Fire Prevention Certificate of Fitness Unit by telephoning (718) 999-1988.

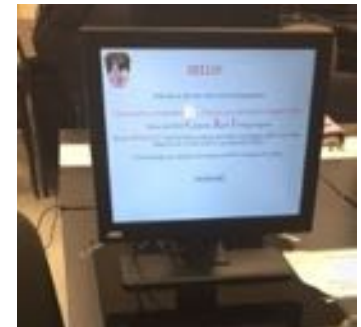

## **Chapter 8. RECORD KEEPING REQUIREMENTS**

### **8.1 Location and format**

An FLS logbook must be maintained at an approved location on the premises (e.g. the Fire Command Center) for purposes of documenting compliance with the requirements of the Fire Code and this section relating to the FDNY plan, including any fires or non-fire incidents, identification of FLS staff on duty at the premises, and the conduct of drills and FLS staff training.

The FLS logbook must be a bound journal with consecutively numbered pages, unless the FDNY has authorized or approved an alternative form of electronic recordkeeping. The front cover must be marked "FLS Logbook" and contain the address of the building.

### **8.2 Entries**

The information provided in this section may be provided as part of the reference material during the school graduation exam or the FDNY exam.

#### *8.2.1 FLS staffing*

Identification of the FLS Director and deputy FLS Director(s) (name and C of F number) and , availability of FLS staff members on duty each day or shift during regular business hours.

Any FLS staff changes, FLS on-site examinations, amendments, and date of the plan acceptance by the FDNY.

#### *8.2.2 Daily entries*

The name of the person who made the entry, the Certificate of Fitness number of the FLS Director on duty, and the time each tour of duty began and ended, must be entered in the FLS log book on a daily basis.

#### *8.2.3 Fire incidents and any implementation of FDNY plan*

- (1) Date and time of the occurrence of any activation of the fire alarm system or any fire-related incident.
- (2) Location of the alarm activation and activated detector type
- (3) Any implementation of the fire safety and evacuation plan

Entries must be made of any evacuation, partial evacuation, or other implementation of the fire safety and evacuation plan, including the affected floors, in-building relocation areas to which they were directed or other directions given:

-Any notifications to the FDNY or other agencies

-Responding department unit and officer

*8.2.4 Fire alarm system off-line entries* If the fire alarm is taken off-line, the following entries should be made:

- (1) Date and time off-line
- (2) Name and C of F number of the person who took off-line
- (3) Reason off-line
- (4) Central station name, phone number of the central station, and name and the C of F number (or ID number) of the operator

- (5) Date and time restored

#### **8.2.5 Non-fire emergency incidents and any implementation of FDNY plan**

- (1) Date and time of the occurrence of any non-fire emergency incident
- (2) Any implementation of the non-fire emergency action plan

Entries must be made of any evacuation, partial evacuation, in-building relocation, shelter-in-place, or other implementation of the emergency action plan, including the affected floors, in-building relocation areas to which they were directed, or other directions given

- (3) Any notifications to the FDNY or other agencies
- (4) Responding department unit and officer

#### **8.2.6 Drills**

The record of each drill that is conducted must be included in the FLS logbook. It is recommended to include the following information:

- (1) the date and time of the drill
- (2) the person(s) conducting the drill, including the Certificate of Fitness number of any drill conductor
- (3) the FLS staff members participating in the drill
- (4) date and time that required notifications (to Department and other agencies) were made, and persons receiving such notifications
- (5) identification of the floors or other areas of the building or occupancy, and the number of building occupants participating in the drill
- (6) the type of drill conducted (fire or non-fire emergency, type of scenario, if applicable, and/or stairway familiarization)
- (7) the special needs addressed
- (8) the problems encountered
- (9) if an evacuation drill was conducted, the weather conditions and time required to accomplish the evacuation
- (10) an outline of the drill content

The drill conductor, if not a member of the emergency preparedness staff of the building or occupancy, must maintain a record of each drill, the location of each presentation, the problems encountered, and an outline of the drill content.

#### **8.2.7 FLS staff training**

- (1) the date of training session
- (2) the person(s) conducting the training session and, the person's Certificate of Fitness number
- (3) the persons attending the training session
- (4) the type of training session conducted (live or computerized instruction)

#### **8.2.8 Fire alarm, sprinkler, standpipe, and emergency power systems**

The FLS logbook should include the record of any inspection, test, and maintenance of fire alarm, sprinkler, standpipe, and emergency power systems. The entries should include

- (1) The date and, the name, and Certificate of Fitness or other license number of any contractor responsible for inspecting, testing and/or otherwise maintaining the building's sprinkler and standpipe systems.

- (2) The job type (inspection, test, or maintenance)
- (3) The frequency requirement (daily, weekly, monthly, etc.) (4) Condition found and any action taken regarding to the condition
- (5) Out-of-service record:
  - Date and time
  - Description of condition and affected areas
  - Notification for out of service and the person receiving the notification
  - Action taken
  - Date and time restored
  - Notification for restoring
  - Responsible impairment coordinator

### **8.2.9 Phase I and Phase II elevator operations**

The FLS logbook should include the record of any test of phase I and phase II elevator operations. The entries should include

- (1) The date of testing,
- (2) person who performed the test: Indicate the name and number of the Certificate of Fitness holder (if applicable), other building personnel (by job title) or a contractor (title and company name).
- (3) condition found and any action taken regarding to the condition.
- (4) verification that elevator keys are located in approved location.

### **8.2.10 Smoke control systems**

The FLS logbook should include the record of any inspection and test of dedicated and/or non-dedicated smoke control systems. The entries should include

- (1) The Date of the inspection/test
- (2) Name of the person who performs the inspection/test
- (3) Job type (inspection/test)
- (4) Normal power and/or emergency power
- (5) Condition found and any action taken regarding to the condition

### **8.2.11 Commercial cooking equipment systems**

Indicate the name and number of the Certificate of Fitness holder (if applicable) or other building personnel (by job title). If inspection, testing, or other maintenance is to be performed by a contractor, indicate as much in the plan, and identify the contractor in the FSP logbook.

### **8.2.12 FLS staff on-site examinations**

The FLS logbook should include the record of any on-site exam taking place in the premises. The entries should include:

- (1) The on-site exam type
- (2) Date and time of the on-site exam
- (3) Name of the candidate who took the exam
- (4) Name of the FDNY inspector who administered the exam

### **8.3 Retention**

According to the 2008 Fire Rule (404-01(s)(4) and 404-02(m) (3)(D)), the Fire Safety Plan (FSP) logbook must be kept at the premises for a period of at least three (3) years from the date of the last entry and the Emergency Action Plan (EAP) logbook must be kept at the premises for a period of at least five (5) years from the date of the last entry. If two books are combined into one logbook, the combined logbook must be kept at the premises for a period of five (5) years. All logbooks must be made available for inspection by Fire Department representatives upon request.

## PART II. FIRE SAFETY TRAINING

### Chapter 9. HISTORY OF FATAL FIRES IN DIFFERENT HIGH-RISE OCCUPANCIES

#### 9.1 Challenge of high-rise building fires

(This section was cited from U.S. Fire Administration/Technical Report Series, Special Report: Operational Considerations for Highrise Firefighting, USFA-TR-082/April 1996, FEMA <https://www.usfa.fema.gov/downloads/pdf/publications/tr-082.pdf>)

High-rise buildings vary in age, size, height, construction, occupancy type, and design features, including the types of fire protection systems that are installed. Fires in high-rise buildings can present severe challenges to first responders.

- Access to floor levels that are beyond the reach of aerial apparatus is generally limited to the interior stairways. The use of elevators is usually restricted or prohibited because of safety concerns.
- Hundreds or even thousands of occupants may be exposed to the products of combustion (e.g. CO or smoke) while they are evacuating or unable to descend past a fire on a lower floor. The exits may be limited to stairways, which are also the only access for first responders coming up to assist with evacuation and to fight the fire.
- The ability to contain and control the fire is increasingly dependent on the construction of the building and the ability of sprinkler and/or standpipe systems to deliver water to the fire area.
- Ventilation can be much more complicated and critical in high-rises than in other types of structures. Vertical ventilation is often limited to stairways or elevator shafts, both of which may also have to be used to evacuate occupants. Horizontal ventilation, by breaking out windows, presents the risk of falling glass to those outside the building. The stack effect may cause smoke to rise rapidly through the vertical passages and accumulate on upper floors.

Stack effect or chimney effect is the movement of air into and out of buildings. The air movement results from temperature and moisture differences. With stack effect, the temperature and pressure differentials between outside air and inside air dictate where the air currents will flow and where smoke is likely to follow. During cold weather, air/smoke is rushing up into the building from the bottom floors and out onto upper floors. During warm weather, when outside temperature is higher than within the building, the opposite can be true: air/smoke will be dropped down to lower floors in building; the smoke may travel to the floor below the fire floor.

One of history's most prominent examples of cold/winter stack effect was the 1993 bombing of the

World Trade Center in New York City. It occurred in February; the outside air temperature was 37°F



and the temperature inside the towers was approximately 75°F. Four-and-a-half minutes after detonation on the Basement 2 level in the parking garage, there was a heavy smoke condition on the 110th floor of Tower 1. Because of the stack effect, the smoke can travel approximately 1,400 feet vertically in less than 5 minutes.

- Reflex time, or the amount of time it takes to react and take action, is usually much higher in high-rise buildings than in non-high-rise buildings. It often takes longer to travel from the ground floor to the fire floor than it takes to respond from the fire station to the building.
- Communications, command, and control can be very difficult in a high-rise fire. Radio transmissions through a building's concrete and steel infrastructure may be compromised. Effective coordination and control of strategy and tactics are essential.

Several major fires have occurred in high-rise buildings where fire protection systems failed to work properly, creating situations where some of the most experienced and well-equipped fire departments could not control the fires. The lessons learned from historical high-rise fires have established that automatic sprinklers are the most effective way to prevent a major high-rise fire. FLS Director must work to ensure that all fire protection systems are tested regularly and function properly.

Some major problems have emerged from recent major high-rise fires across the country. These areas are as follows:

### **1. Water supply and functionality of fire protection systems**

Water supply systems can fail under many circumstances. Closed valves may block the water supply to the system. A fire pump will fail if the main power supply or a backup supply fails. Fire Department Connections may be obscured from view, blocked, or relocated, especially during construction. Pressure reducing valves may be improperly set or improperly installed.

Electrical system failure can be catastrophic since many components of a high-rise fire protection system are powered by electricity. Many buildings have emergency generators in case the main feed to the building is lost. However, even with the presence of backup power systems, the entire system may fail if fire impinges on the main feed.

Stair shafts may become filled with products of combustion, even in buildings designed with protected, pressurized stairs. The First Interstate Bank fire, Meridian Plaza fire, and World Trade Center fire all demonstrated that positive pressure protection can be quickly lost when stairway doors are opened by evacuees and firefighters. Protected stairways intended to provide a safe exit path for both occupants and firefighters are transformed into chimneys carrying smoke and toxic gases.

Elevator failures have hampered operations in many high-rise fires. Some departments prohibit the use of elevators, especially when the bank serves the affected floor, while others allow first responders to use separate unaffected banks to transport personnel and

equipment to staging areas. First responders are particularly dependent on elevators when the fire is on an upper level floor. The Meridian Plaza fire (mentioned in this booklet) demonstrated how firefighting efforts were hampered and delayed when an elevator system failed due to a power loss.

The failure of one component often leads to the failure of other components, generally because the failure allows the fire to grow so large that it impinges on other components or overpowers the ability of other components to function properly. Fire control is extremely difficult when multiple components fail.

## **2. Occupant evacuation**

Recent major high-rise fires have shown that fire departments are likely to have serious problems evacuating occupants from a high-rise, particularly if systems fail, when there is a large volume of fire and no built-in sprinkler system, when occupants are not trained properly, or when the fire is not controlled rapidly. The World

Trade Center bombing demonstrated the problems with evacuation when stairway pressurization systems failed. Even when pressurization systems work properly, however, stair shafts may become filled with the products of combustion because doors on the fire floor are propped open by hose lines and the effect of pressurization is lost as occupants open stairway doors to exit.

Both the First Interstate Bank fire and the Meridian Plaza fire could have trapped thousands of occupants had the fires occurred during weekday hours. The best way to protect high-rise building occupants from smoke and fire is to control the fire rapidly, and this is best achieved by a sprinkler system. Unfortunately, many existing buildings do not offer this protection, which means that fire departments may have to contend with large fires that pose serious evacuation problems.

In some cases, occupants may be safest if they remain in place or evacuate to at least three floors below their current floor instead of exiting the building. FLS Director should determine as quickly as possible in a fire incident whether a full, partial, or no evacuation is necessary, and communicate their evacuation plan to occupants by using the emergency voice communication system. Experience shows that occupants will need guidance with evacuation. This will require the assignment of FLS staff to assist specifically with evacuation.

Evacuation of a high-rise can be one of the biggest challenges in controlling a high-rise fire emergency. Firefighters depend on a prompt, organized evacuation by the FLS Director so that they only have to concentrate on rescuing disabled person, and on the fire attack. Unfortunately, building occupants do not always follow evacuation plans, and many persons may delay exiting and become trapped. This is why it is important for the FLS Director to conduct the required fire and non-fire emergency drills periodically which educate building occupants about the fire safety features of the building, the exits available, and the proper procedures to follow in case of an emergency.

### **9.2 NFPA high-rise building fires report**

(This section was cited from: NFPA's "High-Rise Building Fires," Marty Ahrens, August 2016.

<http://www.nfpa.org/news-and-research/fire-statistics-and-reports/fire-statistics/fires-by-property-type/highrise-building-fires>)

The NFPA report published in 2016 provides estimated annual averages of fires and associated losses in U.S. high-rise building fires during the five-year period of 2009-2013. It includes any fire in a structure at least seven stories in height above ground. Details are provided about high-rise fires in five occupancies: apartments or other multi-family housing, hotels, dormitories or dormitory type properties, facilities that care for the sick, and office buildings.

In 2009-2013, U.S. fire departments responded to an estimated average of 14,500 reported structure fires in high-rise buildings per year.

Five property use groups account for almost three-quarters (73%) of high-rise fires:

- Apartments or other multi-family housing (8,970 fires, 62% of all high-rise fires)
- Hotels (540 fires, 4% of high-rise fires)
- Dormitories (510 fires, 4% of high-rise fires)
- Offices (290 fires, 2% of high-rise fires)
- Facilities that care for the sick (260 fires 2% of high-rise fires)

The report indicates that most high-rise building fires begin on floors no higher than the 6th story. Ten percent of hotel and office building high-rise fires actually started below grade.

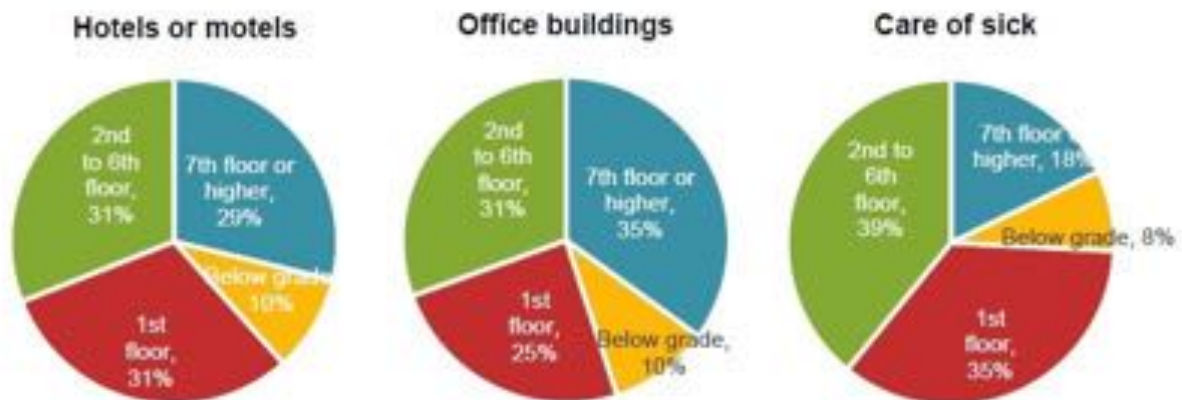

The kitchen or cooking area was the leading area of origin in hotels, office buildings, or facilities that care for the sick.

Top leading areas for hotels, office buildings, and facilities that care for the sick:

- Hotel or motels: Kitchen or cooking area (40%); laundry room or area (8%); bedroom (7%); all means of egress including hallway, lobby, stairway, escalator, etc. (7%) and trash chute, area or container (4%)
- Office buildings: Kitchen or cooking area (31%), office (12%), machinery room or area or elevator machinery room (9%); unclassified equipment or service area (6%), all means of egress (4%).
- Facilities that care for sick: Kitchen or cooking area (39%); lavatory, bathroom, locker room or check room (6%); all means of egress (5%); common room, living room, family room, lounge or den (4%).

## Chapter 10. FIRE DRILL

### 10.1 Qualifications, timing, frequency, and participation

A fire drill conducted for purposes of compliance with Fire Code must be conducted by a person holding a Certificate of Fitness as an FLS Director, FEP Coordinator, or Drill Conductor. A fire drill conducted by a Drill Conductor (W-07 or F-07 C of F holder) in a building or occupancy requiring an FLS Director or FEP Coordinator must be conducted under the personal supervision of such FLS Director or FEP Coordinator. The fire drill must be conducted through live instruction.

Fire drills must be scheduled to maximize the participation of required drill participants. Drills must be scheduled in a manner that best assures the participation of regular building occupants. Drills may be conducted on different work shifts and/or during non-business hours to facilitate the participation of building occupants.

The frequency of fire drills and the building occupants required to participate must be as set forth in the following table:

Type of Building or Occupancy	Required Participation	Frequency
<b>Group A</b>	Regular building occupants. (guests and visitors are not required)	Semiannually
Group R-1 (except homeless shelters and dormitories)	Regular building occupants. (guests and visitors are not required)	Quarterly on each shift
Group R-1 homeless shelter and emergency shelters	All building occupants	Monthly on each shift
Group B office <sup>a</sup> , or other occupancies requiring an FLS Director.	All building occupants	Semiannually
Group B colleges and universities, Group, E educational, and Group R-1 dormitory	All building occupants	In accordance with NYS Education Law

a. **In the 2 years** following acceptance of Comprehensive Fire Safety and Emergency Action Plan, drills must be **conducted quarterly**.

Office buildings and other buildings with Comprehensive Fire Safety and Emergency Action Plans accepted for filing by the Department must continue to conduct separate fire and emergency action plan drills on separate dates.

### 10.2 Presentation requirements and techniques

The presenter must identify him or herself by name, title, and affiliation. The presenter must identify any emergency preparedness personnel or building staff present with whom building occupants should be acquainted, including the FLS Director, FEP coordinator, and other key FLS staff (e.g. FLS brigade members, building evacuation supervisors, wardens, searchers, etc.). When conducting a floor-by-floor presentation in an office building, the presenter should identify

floor wardens and searchers. The FLS staff, including floor wardens and searchers, should wear their vests, hats and/or other indicia of authority so as to familiarize building occupants with the insignia.

All participants must be able to see and hear the presenter. Drills must be conducted in an area conducive to effective communication. Background noise and distractions should be eliminated to the maximum extent possible, but if it not feasible to do so, the presenter must be equipped with a means to amplify his or her voice so that the presentation can be heard clearly.

Drills must be conducted live on the floor or other area of the building on or in which building occupants are generally present, to ensure maximum participation of building occupants. To facilitate effective communication and the use of video or other visual enhancements, drills may be conducted in conference rooms in such areas.

Fire Department encourages owners and the FLS Director to make drills more interesting to building occupants and thereby make the information communicated more memorable. To that end,

(A) Building-specific presentations. Drills must be tailored to the building to make the presentation relevant to building occupants. This includes a building description and references to building features, occupancies and other relevant information that will assist building occupants in understanding the design and arrangement of the building and building systems and how they relate to the response to different types of emergencies.

(B) Visual enhancements. The Department encourages presenters to include visual enhancements to supplement their drill instruction. Floor plans can be used to illustrate stairway locations and evacuation routes, signs can be used to emphasize key words or concepts, and photographs or video can be used to illustrate fire or non-fire emergencies.

(C) Use of actual incidents and lessons learned. Whenever possible, illustrate the information being presented by reference to actual fires or non-fire emergencies, including those that received public attention, and the lessons learned from those incidents.

### **10.3 Persons with special needs**

Every reasonable effort must be made to ensure the participation in drills of building occupants who have identified themselves (in accordance with emergency preparedness plan procedures) as having special needs that may require assistance in the event of an emergency. Their participation will aid in identifying and addressing their needs in advance of the emergency. Where such building occupants are not able to participate in a drill or it is not feasible to accommodate their needs during the drill, alternative arrangements must promptly be made to communicate in a suitable manner the information presented during the drill to such persons and consider their needs.

Explain to all drill participants that persons with special needs, who will require assistance in evacuating from the building or relocating within the building, including persons with disabilities, should identify themselves in accordance with the emergency preparedness procedures for the building or occupancy, so that the FLS staff are aware of their needs and take their needs into consideration. Explain what those procedures require. Encourage a person with special needs to introduce themselves to floor wardens, searchers, other emergency preparedness staff, and co-workers willing and able to provide emergency assistance, and inform them of their special needs. Encourage other building occupants to volunteer to assist persons with special needs in the event of an emergency.

## **10.4 General content of all drills**

Drills must be conducted to enhance the fire and non-fire emergency preparedness of building occupants, including building staff and employees of building tenants. Drills must serve to familiarize building occupants with the proper actions to take in the event of a fire or non-fire emergency and fire prevention measures appropriate to the occupancy. Drill conductors must incorporate the following basic information in their presentation, with elaboration appropriate to the building or occupancy.

During the drill, the FLS Director should communicate the following information to the building occupants:

- (1) Emphasize the importance of listening for and complying with the directions from on scene emergency responders or other lawful authorities.
- (2) Explain that the FLS staff are trained to keep building occupants safe.
- (3) Emphasize the importance of listening for their announcements and directions.
- (4) Encourage building occupants to comply with the directions of building FLS staff, who are trained and in the best position to assess the safest response, but explain that building occupants should exercise their own best judgment if they are in immediate jeopardy, taking into consideration all known information and the guidance they are being given. For example, in a fire incident, direction may be given to evacuate a building through a designated stairway or exit, but if a building occupant assesses that he or she cannot safely reach that stairway or exit, the building occupant must exercise his or her own best judgment as to the safest course of action and should attempt to notify the FLS Director of an issue with the stairs.

## **10.5 Content of fire drills**

The fire drills are being conducted to educate building occupants about the actions they should take in the event of a fire. The presenter must communicate the following information to the building occupants with respect to fire drills:

### ***10.5.1 Notification of 911 and the FLS Director***

Emphasize the importance of reporting any emergency to 911. In a fire drill, instruct building occupants to first use the manual pull station to activate the fire alarm system and to immediately call New York City 911 upon reaching a place of safety. In office buildings, the floor wardens will also communicate with the FLS Director via warden phone.

### ***10.5.2 General building description***

Describe the building in which the drill is being conducted. For example: "You are occupying a 30-story building built in 2004. It is of non-combustible construction, meaning that the building structure is made of steel and concrete. The building is equipped with a sprinkler system and a fire alarm system. There is a Fire Command Center in the office building lobby staffed by a Fire and Life Safety director during regular business hours. The first three floors are occupied by stores and other retail businesses serving the public. Floors 4 to 20 are office spaces. Floors 21 through 30 are house apartments. The retail space has its own elevators and stairways. The office and apartment occupancies have separate lobbies and elevators, but share stairways." In a mixed occupancy building, such as the office/residential building, address whether the occupants of the other occupancy share the same means of egress or will otherwise interact with each other during an emergency.

### **10.5.3 Fire alarm system and method of notification**

The presenter shall describe the type of fire alarm system that is installed in the building, or in the occupancy in which the drill is being conducted, and how it is used to notify building occupants of fires.

Describe the type of fire alarm system that is installed in the building, or in the occupancy in which the drill is being conducted, and how it is used to notify building occupants of fires. For example, explain a high-rise-type fire alarm system is designed to detect heat and smoke, and may also be manually activated.

#### **(1) High-rise-type systems.**

If a high-rise-type fire alarm system is in use, explain that it is designed to detect heat and smoke, and may also be manually activated.

#### **(2) Manual/automatic fire alarm systems**

If manual/automatic fire alarm system is in use, indicate whether it is designed to detect heat and smoke, or is only manually activated. Emphasize the heightened importance of an immediate response to the activation of a fire alarm in buildings, especially in those that are not fully protected by a sprinkler system.

#### **(3) Voice communication capability and notifications.**

State whether or not the fire alarm system has voice communication capability, , and describe the system's auditory and visual alerts (alert tones and strobe lights). Identify any areas of the building or occupancy not equipped with alerts. Distinguish the fire alarm system's loud, continuous tone or other alert sounds from the inquiry tone by which building occupants may be notified of a non-fire emergency. If there are any other means by which building occupants will be notified of a fire, explain these means. Address the fire alarm system's sequence of operation and the importance of relocating below the fire floor (typically at least three floors down) in conjunction with the emergency procedures to be followed (refer to 10.5.5 and 10.5.6).

#### **(4) Manual pull station.**

Identify the location of the system's manual pull stations. Explain how to operate a manual pull station and indicate whether it sends a signal to a central station or only rings in the building. Emphasize that the manual pull station is to be used only when fire or smoke conditions are actually observed, and not merely when there is the odor of smoke. Explain that using the manual pull station in the absence of observable flames or smoke can confuse emergency responders as to the location of the fire, given that smoke can quickly travel throughout the building. Also explain that the manual pull stations are not to be used during an active shooter emergency or to notify others of any other non-fire emergency, as it may cause building occupants to enter the stairways and/or evacuate the building when they should be sheltering in place.

#### **(5) Announcements.**

If the fire alarm system has voice communication capability and is programmed for a staged evacuation sequence of operation, advise *building occupants* to listen for an announcement when the *fire alarm system* activates. Advise building occupants to move toward the closest or designated stairway when the fire alarm sounds and, if no further information is forthcoming, to proceed down the stairs and exit the building. In a building or occupancy with an interior fire alarm system that alarms on all floors, advise *building occupants* to quickly and safely proceed to the closest stairwell and exit the building.

#### (6) **Warden phones.**

In office buildings equipped with warden phones, and in other buildings and occupancies equipped with telephones that directly communicate with the Fire Command Center or other emergency operations center, identify the location of such telephones, explain their purpose (to report fire conditions and/or the status of building occupants on the floor or other area) and demonstrate how to operate them. Emphasize the need to wait for the Fire Command Center to answer the call as warden phones typically operate on a single telephone line and multiple calls cannot be answered at once.

#### **10.5.4 Means of egress**

The presenter must identify all of the means of egress (such as hallways and stairwells leading to exterior doors and external stairs and fire escapes) in the building or, if the presentation is limited to occupants on a particular floor or area of the building, all the means of egress available on that floor or in that area, and any other areas that the building occupants on that floor or area may regularly access.

##### (1) **Stairways**

Describe and/or illustrate the location and letter designation of the stairways. State whether the doors in the stairways are locked to prevent reentry into the building, and, if so, on what floors reentry is allowed (typically every fourth floor), and that they should unlock when the fire alarm activates automatically or there is a power outage. During the required stairwell familiarization drill highlight any unusual features (such as in-stairwell horizontal passageways). If there are access stairs between floors, emphasize that they are not designed for use during a fire because they are not enclosed, and therefore do not protect building occupants from smoke and may become unsafe during a fire. Explain that the activation of manual pull alarm system may not release the fail-safe doors automatically; the FLS Director has to manually release the doors after confirming there is a fire/smoke condition.

However, some old buildings under 100 feet may be allowed under the 1968 Building Code to lock all stairway doors to prevent reentry except at the street level. All occupants in these buildings must exit to the designated outdoor location.

##### (2) **Fire tower**

If the building has a fire tower, explain what that is, and identify the location where it can be accessed. **Fire tower stairway should be given priority for building occupants to use for evacuation.**

##### (3) **External stairs and fire escapes**

If the building or floor has external stairs or fire escapes, identify where those means of egress can be accessed. Explain that fire escapes are a secondary means of egress and should only be used if the primary means of egress (stairways) are not safe. Explain that fire escapes are not designed to hold a large number of persons at one time.

##### (4) **Egress route and exit**

For each stairway or other means of egress, describe the route of the means of egress and the location at which it terminates (the street name/number if outdoors, the building location if indoors). For example: "Stairway A, located on the south side of the building, just outside of the elevator lobby, goes to the building lobby, from which you can exit through the front entrance to Eighth Avenue. There is also a door in the rear of the lobby that leads to the service entrance/loading dock area on 50th Street. Stairway B, located on the south side of the building, near the freight



elevator, exits directly onto 51st Street. There are two other stairways, on the third floor only, from inside the Auditorium and the Cafeteria, that exit directly onto 49th and 50th Streets, respectively. The doors to those facilities may be locked between 6 pm and 8 am.”

#### **(5) Areas of refuge**

If the building has been designed with areas of refuge (also known as areas of rescue assistance) to allow persons to shelter in a designated area on each floor, identify the location of such areas and explain that they are designed to shelter building occupants if for any reason they are unable to evacuate the floor or exit the stairwell.

#### **(6) Maintenance of self-closing doors**

Emphasize the importance of not chocking open or otherwise interfering with the operation of self-closing doors, especially stairway doors. Explain that self-closing doors are designed to maintain a fire and/or smoke separation and that keeping them open allows a fire to spread and smoke to contaminate the stairways needed for occupant egress.

Explain whether the corridor doors are equipped with fail-safe device and when the device will be released.

#### **(7) Elevators**

Emphasize that elevators are not to be used during a fire, because the elevators may operate erratically; stop at the fire floor, exposing the passengers to unsafe conditions; lose power and trap passengers; and/or fill with smoke. Consult the Department’s website for guidance with respect to occupant evacuation elevators that may have been installed in very tall buildings constructed since 2014.

### ***10.5.5 Emergency procedures (in buildings of non-combustible construction)***

When conducting a fire drill in a building of non-combustible construction, the presenter must communicate the following information to building occupants:

- (1) the sequence of operation of the fire alarm system, that is, whether the system is designed to ring only on the fire floor, floor above, and/or floor below, or throughout the building;
- (2) what non-combustible construction means and why sheltering in place is recommended for building occupants if not in immediate jeopardy;
- (3) building occupants may be directed to use a designated stairway;
- (4) in a building with a fire alarm system programmed for a staged evacuation sequence of operation, the goal is to move to an area of safety below the fire floor. As such, building occupants generally only need to relocate several floors below the fire floor, rather than evacuate the building. Instruct building occupants that, unless directed otherwise, to relocate at least three floors below the floor upon which the fire alarm system is activated. Emphasize that evacuating higher up in the building or to the rooftop may increase the danger and make rescue more difficult;
- (5) in a building with an interior fire alarm system that alarms on all floors, the goal is for occupants to quickly but safely proceed to the closest stairwell and exit the building.
- (6) choosing to evacuate or relocate within the building, when one should shelter in place instead, may delay the Fire Department’s response and unnecessarily expose building occupants to danger;

- (7) the hazard of smoke inhalation, and the importance of ascertaining the presence of smoke in building corridors and stairways before evacuating. Due to the different ways smoke can spread in a high-rise building (the Stack Effect), stairways below the fire floor could become contaminated by the reverse flow of smoke;
- (8) the importance of closing but not locking doors as they exit, and, if doors lock automatically, taking keys in case fire or smoke conditions prevents their evacuation or relocation and requires that they retreat to their point of origin; and
- (9) if unable to in the event that you are in jeopardy and unable to safely evacuate the floor, retreat to a room with a solid door and call 911; notify them of your location, and seal the spaces around the door with wet towels, duct tape, or other material to prevent or reduce smoke infiltration.

**10.5.6 Emergency procedures (in buildings of combustible construction).**

When conducting a fire drill in a building of combustible construction, the presenter must communicate the following information to building occupants:

- (1) the sequence of operation of the fire alarm system, that is, whether the system is designed to ring only on the fire floor, floor above and/or floor below, or throughout the building;
- (2) what combustible construction means, and that evacuation from the building is recommended if conditions allow, given the risk of fire spread to the building structure. Building occupants should take the stairs to the street level or other main floor and exit the building, unless directed otherwise;
- (3) in buildings not protected by a sprinkler system, emphasize the importance of responding immediately to a fire alarm, as a fire can double in size every minute; and.
- (4) each of the items set forth in Section 10.5.5 of this book (4) through (9).

## Chapter 11. FLS DIRECTOR RESPONSIBILITIES IN FIRE EMERGENCIES

### 11.1 Inspection and prevention of fires

The FLS Director must ensure that the building's fire protection systems and other equipment and operations affecting building fire safety are inspected, tested and maintained periodically by qualified personnel (e.g. qualified Certificate of Fitness holder, etc.). Daily visual inspection of the Fire Command Center has been the industrial practice and is highly recommended by the Fire Department. The purpose of the visual inspection is to detect defective components or abnormalities.

The FDNY recommends that the FLS Director should perform a visual inspection daily. If any problem is found, the FLS Director must have the defect(s) corrected.

- (a) **Inspect all exits, stairways, and hallways to determine condition and availability for use.** All exits, stairways, and hallways must be kept free of blockage. Blocking the exit may prevent occupants from leaving the building. Corrections must be made for proper way of exit with doors opening in direction of travel. An exit aisle is generally required to be at least 3 feet wide.

Locks, bolts, and chains must not be installed on the exit doors while the building is in use. If locks are seen they **must** be removed immediately.

- (b) **Check all the doors in the affected areas to see operation conditions and availability for use.** Close attention must be paid to the stairways and areas where fire doors are installed. Exits into the stairway must be available from each floor of the building. Usually, a panic bar is installed on the door. The panic bar allows the occupants to quickly exit from the premises in case of an emergency. The FLS Director must ensure that the fire doors exist, and are in good working order.
- (c) **Ensure that self-closing doors are not blocked and are closed at all times (when not in use).** The FLS Director must ensure that all self-closing doors are not left open for any reason. Self-closing doors are made to slow down the spread of fire during emergency. These doors must be marked with a sign stating that they are self-closing doors. All self-closing doors in the building must be kept in good working order. They must be checked to make sure that they can be opened and closed freely.
- (d) **Ensure that exits are properly labeled, and hallways and stairways are lit.** Emergency lighting must be provided for exits. Directional signs must clearly show the path to exit. Exit signs posted above doors and emergency lighting must be lit.
- (e) **The entire location must be checked daily for ignition sources.** Any likely ignition sources that are found must be immediately fixed or removed. For example, arcing or exposed electrical wiring should be reported.
- (f) **Smoking is prohibited.** The Smoke Free Air Act of 2002 bans smoking in most workplaces, including bars, restaurants, clubs, offices, and other public areas. The FLS Director must enforce the no smoking rules.
- (g) **Constantly inspect premises for buildup of rubbish.** Trash and garbage must not to be allowed to accumulate inside the building. Accumulated trash is a fire hazard. It may be easily ignited by a stray spark.

All trash and garbage must be removed from the premises or building owner must be promptly notified.

- (h) **Ensure fire extinguishers and fire alarm pull stations are readily available.** All fire extinguishers and pull stations must be clearly visible and easily accessible.
- (i) **Hot work operation may be prohibited.** The FLS Director must know that no hot work operation is allowed in areas of a building **where the sprinkler system is impaired.**

The FLS Director must be aware of any change of building system that may impact fire safety.

## 11.2 Human behavior and personal safety of building occupants

This section was cited from two journal articles:

Ronchi E. and Nilsson D. (2013), Fire evacuation in high-rise buildings: a review of human behaviour and modelling research. *Fire Science Reviews*.  
<https://link.springer.com/article/10.1186/2193-0414-2-7>

Fahy, R. F. and Proulx, G. (2009), '*Panic*' and human behaviour in fire. National Research Council Canada. <http://tkolb.net/FireReports/PanicInFire09.pdf>

Ronchi and Nilsson (2013) indicated that the performance of people during a fire in a high-rise building may be associated to the type of buildings:

### (1) Office buildings:

From a design perspective, office buildings have generally open floor plans, which limit the possibility of containing the fire within a compartment. Occupants are generally better prepared to evacuate the building since they are typically trained through evacuation drills and they are dressed, alert, and responsible mainly for themselves. Occupants may be more familiar with the elevator egress component if elevator systems are used. Fire systems are generally well-maintained, and may include recorded voice messages and fire alarms. Trained staff with particular responsibilities in a fire may be available on hand to facilitate evacuation.

### (2) Residential buildings:

Residential buildings present completely different characteristics from both a design perspective as well as the characteristics of the population involved. Occupants may be asleep, not dressed, etc. (i.e., they are not ready to evacuate, thus causing a long delay in the start of the evacuation). Pre-evacuation times are therefore generally higher than other types of building occupancies. Different reasons may be the cause of long pre-evacuation times. Occupants may be emotionally tied to the structure and its contents leading to potential re-entry behaviors. Occupants may also be more reluctant to leave their own property for the same reason. In addition, information spread is slower due to compartmentation, and social links can delay movement. Occupants in hotels are not familiar with the environment. The population in hotels is in fact transient, causing possible difficulties in adopting the appropriate escape route in the case of fire.

### (3) Health care facilities (HCF)

In particular, the population in this type of environment presents different characteristics, involving people with temporary or permanent disabilities and mobility impairments. HCFs may have staff on hand (but number or ratios may depend upon the time of the day), but they also have a higher number of occupants that are not able to perform self-rescue activities. The intrinsic characteristics of a high-rise building, i.e. long travel distances for

people in the upper floors and vertical evacuations (e.g., the need for multiple elevator trips), demonstrate the importance of an effective egress strategy for this type of population.

Many problems need to be addressed, such as the issues concerning fatigue, way-finding, use of vertical components (e.g. stairs, elevators), etc. These problems may be exacerbated in the case of a significant percentage of people with impairments.

The level of training of the staff becomes therefore another key factor in the evacuation performance of the building. From both an individual and group perspective, little research has been carried out in order to study the evacuation behaviors of vulnerable users, e.g., people with disabilities, elderly, etc., whose behavior may strongly affect the egress performance of a building.

Fahy, Proulx and Aiman (2009) reviewed series case studies in fire or catastrophic events. They indicated individuals in general often use the term 'panic' to describe their own emotional state and as an assessment of their ability to respond to a problem when they feel stressed, anxious or scared. However, people normally do not behave in an irrational or antisocial manner in fire incidents. The case studies reported that the common elements that tend to lead to panic are: the fire spread at an incredible speed; there are limited known or available exits, and the buildings are overcrowded. This study indicates that **information is the key to a successful building evacuation during an emergency**. It suggests that the building staff should not see the building occupants as a mass of irrational people who need to be controlled. **Withholding information or using coded information among staff to prevent occupants' knowing that there is an emergency can be very harmful**. It is much more constructive, and more likely to lead to a positive outcome by providing the occupants without delay with the information that they need to make the right decisions. **When provide information, people can refine their situation awareness, making them more competent at weighing their options before engaging in proper actions**. If the occupants are not familiar with the building (e.g. hotels, shopping malls, etc.), it is essential that FLS Director and all FLS staff must provide the timely information to support occupants' decision-making.

### **11.3 Occupants with disabilities and special needs**

The FDNY plan must specify the procedures for identifying occupants who require assistance, and the procedures for providing such assistance. The list of occupants who have requested assistance must be prepared and maintained at the Fire Command Center.

In the event of fire/smoke situation, FLS Director should notify the designated personnel to assist the disabled individuals.

### **11.4 Implementation of fire safety and evacuation procedures**

In the event of a fire or smoke condition, the FLS Director must ensure that 911 is called immediately and state the determination of implementing the FDNY plan. If arson (i.e. intentionally damaging the property of another without consent of the owner by intentionally starting a fire or causing an explosion) has occurred or is about to occur, the FLS Director must also call the police (911).

When notifying 911 of a fire or other emergency, the call-taker will need to obtain certain information about the emergency. The nature of the emergency and address are the most critical pieces of information. The operator may also ask what the nearest cross-streets are, and if anyone is in need of medical attention and if so, what are their symptoms. Additionally, if responsible for a very large premises, it is likely that there will be more than one means of entry. Providing information about which entrance would provide the most direct access to the emergency area would be helpful in

getting the emergency response personnel to the area of the emergency as quick as possible. The more information the caller has available to communicate to the 911 operator, the quicker the first responders can reach the premises.

When calling 911, in addition to the information mentioned above, the caller should be prepared to answer other 911 operator questions, which may include

- Type of occupancy (e.g. hotel, office building, etc.)
- The phone number the 911 operator can reach the caller
- The nature of the emergency
- Details about the emergency, such as the description of the fire/smoke condition and fire location, if known
- If the FDNY plan has been implemented.

Be prepared to follow any instructions the operator provides. Do not hang up until the operator instructs you to.

#### ***11.4.1 Important information in fire emergencies***

In the event of fire/smoke condition or the activation of a fire alarm, the FLS Director must

- immediately report to the Fire Command Center
- acknowledge the alarm (if applicable).
- address the alarm panel to verify the location and which initiating device(s) is/are activated:

(a) manual pull station (b) smoke, beam, duct detectors (c) heat detectors (d) water-flow device

- ensure all the elevators are recalled
- communicate with FLS staff: contact FLS wardens who are located on the floor(s) with fire alarm activities or direct the FLS brigade members to obtain the following information:
  - (1) Location of the fire (floors and areas on floors)
  - (2) Severity of the fire/smoke condition
  - (3) Floors affected by smoke conditions
  - (4) Stairways affected by smoke conditions
  - (5) Floors occupied at the time of the fire and the number of building occupants in such areas

These factors must be expeditiously determined and considered in implementing the fire safety and evacuation procedures in the event of a fire in the building. The primary communication must be made verbally. Text or email should not be used as the primary method of communication for fire emergencies.

#### ***11.4.2 Implementation procedures***

(1) Mobilize FLS brigade members/FLS wardens and other FLS staff

The FLS Director needs to assign the FLS brigade members the following duties:

- Assist in the evacuation/relocation of the floors with fire alarm activities (i.e. the affected floors) to at least 3 floors below from their current floor or consistent with the FDNY plan;

- Control small fires by using fire extinguishers or closing doors (if safe to do so);
- Maintain communication with the FLS Director and follow the FLS Director's instructions;
- Instruct at least one brigade member to report to the floor below the fire to meet the fire-fighters.

The FLS Director needs to assign the FLS wardens and deputy FLS wardens the following duties:

- Assist in the evacuation/relocation of the floors with fire alarm activities (i.e. the affected floors) to at least 3 floors below their present location or consistent with the FDNY plan;
- Maintain communication with the FLS Director after the relocation/evacuation and follow the FLS Director's instructions.

- (2) Identify stairway(s)/stairwell(s) for evacuation/relocation of building occupants and stairway(s) for use by responding firefighting personnel.

If any stairway door is locked, the FLS Director must ensure every door is openable during the fire emergency. For example, ensure all the fail-safe devices have been released. The FLS Director must identify a stairway for firefighting personnel access. He/she must also help maintain a clear path from the lobby to the stairway access.

The FLS Director also must identify the stairway for building occupants to use. Fire tower stairway should be given priority for building occupants to use for evacuation/relocation.

- (3) Make announcement(s) to building occupants informing them of the fire condition and its location. Instruct them not to use elevators unless directed to do so by firefighting personnel. The FLS Director must notify the affected floors first including the fire (alarm) floor(s), floor above and floor below the alarm (if

applicable), and then inform all the building's occupants of the alarm (by making an "all call announcement").

- (4) Instruct building occupants on the fire floor, the floor above, and the floor below (if applicable) the fire floor to immediately leave these floors, and evacuate the building or relocate to another safe location within the building at least three (3) floors below their present location or evacuate the occupants consistent with the FDNY plan. Identify the stairways(s) or other routes of egress for their use and direct them to use only those stairways(s) or routes of egress. Instruct building occupants to close stairway doors behind them.

- (5) Building occupants may be instructed to exit the stairway at a designated floor if the stairway is needed for responding firefighting personnel.

- (6) Instruct brigade members to assist building occupants with special needs who are unable to use the stairways or other designated route of egress without assistance.

- (7) Unless fire and smoke conditions warrant otherwise, instruct building occupants on floors with no fire alarm activities (i.e. unaffected floors) to shelter in place and not move around the building, pending further direction from the FLS Director or firefighting personnel.

- (8) Monitor the progress of the fire and smoke conditions by monitoring the fire alarm control panel and maintaining regular communication with FLS staff.

- (9) Ensure the HVAC system has been shut down. Consult with the building engineer (if applicable).

#### **11.4.3 Use of Elevators**

**In the event of fire/smoke condition or the activation of a fire alarm, the FLS Director must ensure that the elevator Phase I operation has been activated automatically or manually.**

Elevators must not be used to implement the fire safety and evacuation plan except under the following circumstances:

- Where such use is conducted or authorized by firefighting personnel.
- Where such use is made necessary by fire, heat, or smoke conditions in stairways preventing or hindering the evacuation or in-building relocation of building occupants, and the FLS Director or deputy FLS Director determines that the elevators can be safely used, subject to the following provisions:
  - Elevators which operate in a shaft that does not serve (stop at) the fire floor or have openings on the fire floor may be used. Elevators serving (stopping at) the fire floor or having openings on the fire floor must not be used under any circumstances.

Note: Very tall high-rise buildings may have blind shafts in which elevators serving upper floors pass many floors without door openings. An example of a blind elevator shaft: there is a hoist-way door on the first floor and not another one until upper floors.

- Only elevators provided with two-way voice communication to the Fire Command Center in accordance with Building Code requirements may be used for these purposes.
- Movement of elevators must be controlled either by operation in manual mode by an FLS staff member or at the elevator control panel in the lobby, under the direct supervision of the FLS Director.

#### **11.5 Interaction with the Fire Department during fire incidents**

The FLS Director, all other FLS staff and building occupants must comply with the orders of FDNY firefighting personnel. The lobby and the building entrance must be kept clear for the FDNY access. When the Fire Department arrives, the FLS Director must remain on the Fire Command Center to greet FDNY firefighting personnel, at least one fire brigade member should be remained on the floor below the fire floor to provide information to FDNY firefighting personnel, and the Building Engineer should be available and prepared to follow FDNY firefighting personnel's instructions.

FLS Director should silence the fire alarm system when authorized by FDNY firefighting personnel. Audible silence allows for easier communication for FDNY firefighting personnel while responding to an alarm.

FLS Director is, required to notify arriving FDNY firefighting personnel and other first responders of the nature of the emergency and the actions already taken. FLS Director should also provide the following materials to FDNY firefighting personnel:

- Floor plans
- Building Information Card (BIC)
- FDNY Plan



- Elevator and stair diagrams
- Elevator keys
- Any other master keys/access cards that may be required
- Premises security radios/walkie-talkies

FLS Director, may need to quickly provide FDNY firefighting personnel with the following information, if known:

- Location of the fire or alarm
- The nature of the alarm (what cause the alarm)
- The conditions on the fire floor and floor above (including smoke condition)
- The status of the stairways (stairway being used by occupants and stairway suggested to be used for  
FDNY firefighting personnel, location of the standpipe risers)
- Evacuation/relocation status
- Status of elevators and HVAC system
- The location of the evacuated/relocated people
- Any problems with the evacuation/relocation
- Number of potential victims at the location
- Any people unaccounted for
- Any problems reported to you
- Any impairment of the fire protection system

It is critical for the FLS staff to follow orders of FDNY firefighting personnel. FDNY firefighting personnel may request assistance of the FLS Director and other FLS staff to operate and control the building systems.

FLS Director required to silence and reset the fire alarm system when he or she are authorized by the Fire Department and the condition has been cleared.

## Chapter 12. CASE STUDY: FIRE EMERGENCIES

This booklet reviews fire incidents that occurred in different occupancies. The instructor must select at least three cases from the five incidents including one office building case, one hotel case and one case from other occupancies (shopping mall, club, or hospital) to have an open discussion and classroom exercise with the students. The FDNY recommends that candidates should also study the other cases in this booklet that the instructor did not discuss. The school graduation exam and/or FDNY computer exam may cover any case study from this booklet. The FDNY provides schools the recommended answers for all discussion questions. Every school should provide these answers to the students after the case discussion session.

### 12.1 High-rise office building fire

#### 12.1.1 One Meridian Plaza fire, PA (1991)

(Detail discussion should be referred to: U.S. Fire Administration/Technical Report Series, High-Rise Office Building Fire One Meridian Plaza, USFA-TR-049/February 1991, FEMA <https://www.usfa.fema.gov/downloads/pdf/publications/tr-049.pdf>)



One Meridian Plaza is a 38-floor skyscraper in Philadelphia that suffered a severe fire on February 23, 1991. The fire is one of the most significant highrise fires in US history. The fire claimed the lives of three Philadelphia firefighters and gutted eight floors of a 38-story fire-resistive building causing an estimated \$100 million in direct property loss and an equal or greater loss through business interruption. Litigation resulting from the fire amounts to an estimated \$4 billion in civil damage claims.

#### Delayed Report

The fire started in a vacant 22nd floor office in a pile of linseed oil-soaked rags left by a contractor. At approximately 2023 hours on February 23, 1991, a smoke detector was activated on the 22nd floor of the One Meridian Plaza building. The activated detector is believed to have been located at the

entrance to the return air shaft in the northeast corner of the building (Due to incomplete detector coverage, the fire was already well advanced before the detector was activated). At that time, there were three people in the building: an engineer and two security guards. The alarm sounded throughout the building, and elevator cars automatically returned to the lobby. The building engineer investigated the alarm using an elevator on manual control to go to the 22nd floor. The central station monitoring company that served the building reportedly called the guard desk in the lobby to report the alarm. The call came in before the engineer reached the fire floor, and the alarm company was told that the source of the alarm was being investigated. The alarm company did not notify the fire department at that time.

When the elevator doors opened at the 22nd floor, the engineer encountered heavy smoke and heat. Unable to reach the buttons or to leave the elevator car to seek an exit, the building engineer became trapped. He was able to use his portable radio to call the security guard at the lobby desk requesting assistance. Following the trapped engineer's instructions, the security guard in the lobby recalled the elevator to the ground floor. The second security guard monitored the radio transmissions while taking a break on the 30th floor. This guard initially mistook the fire alarm for a security alarm believing that he had activated a tenant's security system while making

his rounds. He evacuated the building via the stairs when he heard the building engineer confirm there was a fire on the 22nd floor.

The lobby guard called the alarm-monitoring service to confirm that there was an actual fire in the building when the engineer radioed to her from the 22nd floor but she did not immediately call the fire department.

The first call received by the Philadelphia Fire Department came from a passerby who used a telephone near the building to call 9-1-1. The caller reported smoke coming from a large building but was unable to provide the exact address. While this call was still in progress, at approximately 2027 hours, a call was received from the alarm-monitoring service reporting a fire alarm at One Meridian Plaza.

### **Electrical Power Failure**

The Philadelphia Fire Department initiated its high-rise emergency procedures and began the ascent to the 22nd floor. Shortly after members reached the 11th floor, the building completely lost electrical power. Fire had burned through the electrical cables and plunged the entire building into darkness. The emergency generator should have activated automatically, but it failed to produce electric power. These events left the entire building without electricity for the duration of the incident in spite of several efforts to restore commercial power and to obtain power from the generator. This total power failure had a major impact on the firefighting operations. The lack of lighting made it necessary for firefighters to carry out suppression operations in complete darkness using only battery powered lights. Since there was no power to operate elevators, firefighters were forced to hand carry all suppression equipment up the stairs to the staging area that was established on the 20th floor.

### **Water Supply problem**

Firefighters were unable to get sufficient water pressure from the incorrectly set pressure-reducing valves found on the standpipe outlets. It was not until several hours into the operation that a trained technician who knew how to adjust them arrived at the fire scene.

### **Firefighting Operations Suspended**

All interior firefighting efforts were halted after almost 11 hours of uninterrupted fire in the building. After consulting with a structural engineer about the possibility of collapse and the loss of three firefighters, an order was given to evacuate the building. At this point, the fire was controlled on the 22nd through 24th floors but continued to burn on floors 25 and 26 and extend upward.

### **Fire Stopped**

The fire was stopped when it reached the 30th floor, which was protected by automatic sprinklers. The fire was declared under control 3:01 p.m. (approximately 19 hours after the smoke detector fire alarm), February 24, 1991.

### **What are the major issues in this One Meridian Plaza fire?**

---

---

---

---

**What could have prevented this fire from becoming catastrophic?**

---

---

---

---

---

**What should the response of an on-duty FLS Director be when a smoke detector activates?**

Refer to Chapter 11 of this booklet. In general, before the FDNY arrives, the FLS Director must perform every necessary step mentioned in Section 11.4 of the booklet. When the FDNY arrives, the FLS Director must assist the FDNY by arranging required pathway, staff, equipment and documents for the FDNY use. The FLS Director also needs to report all required information to the FDNY (refer to Section 11.5 of the booklet). The FLS Director must silence and reset the fire alarm system when authorized by the FDNY.

## **12.2 High-rise hotel building fire**

### **12.2.1 Doubletree Hotel fire, New Orleans, LA (1987)**

(This section was cited from: U.S. Fire Administration/Technical Report Series, Doubletree Hotel Fire, USFA-

TR-008/July 1987, Homeland Security: <https://www.usfa.fema.gov/downloads/pdf/publications/tr-008.pdf>)

The hotel is a 17-story high-rise and contains 363 guest rooms. The building is constructed of reinforced concrete and appears to qualify as Type 1 construction: non-combustible/fire-resistive. The fire occurred on a Sunday just after 10:00 p.m. and started in a corridor serving guest rooms on the tenth floor. The floor was unoccupied and undergoing renovation at the time. The cause of the fire was arson. Due to the failure of the automatic fire alarm system, the fire gained significant headway before being detected. It is the most significant factor allowing the fire to become a major incident.

At approximately 10:15 p.m., an elevator alarm began to sound. The building engineer and security guard were dispatched to find the stopped elevator, each taking a portion of the building. During the search, the engineer encountered smoke, so he instructed the building occupants to evacuate. He returned to the lobby to direct the Fire Department. (The Fire Department received its first call from the hotel operator and dispatched first alarm units at 10:32 p.m.)

As the security guard entered the tenth floor, he probably encountered heavy smoke and activated the pull station at Stairway 2. He was eventually discovered collapsed and died at a hospital. At the time of the fire, the tenth floor was unoccupied and undergoing renovation. As part of the renovation process, large wooden cabinets were being provided in each room. Employees who had been installing the cabinets had stored the cardboard boxes and sheets of solid foam, most of which had been flattened and stacked against the wall, in the corridor. An estimated 10 to 20 boxes that were stacked outside Room 1001 were probably burning when the guard entered the tenth floor.

The engineer had since arrived at the lobby and called the chief engineer for the hotel, who instructed him to shut off the air handling units. The engineer attempted to go up the stairway with the firefighters, but was told to go back. Without informing the arriving first responders and

carrying proper protective equipment, the engineer boarded an elevator and went to the seventeenth floor to shut off the building's fans. Although the elevator filled with smoke on the way up, he was able to get to the seventeenth floor and access the fan controls. Now trapped by smoke, he called the lobby for help. The chief engineer had arrived and advised him of a means to access a second stairway, which the engineer used to escape.

Some occupants said they failed to evacuate when the fire alarm went off because of a previous series of false alarms. These occupants complained that they were not aware that there was an actual fire until they smelled smoke or were later told to evacuate.

The incident was terminated at 03:17 on Monday morning after nearly 5 hours. Following the fire, the Fire Department issued citations to the hotel for illegal storage in an exit corridor and for failure to properly maintain the fire alarm system.

**What are the major issues in this Doubletree Hotel Fire?**

---

---

---

---

---

---

---

**What could have prevented this fire from becoming catastrophic?**

---

---

---

---

---

---

---

**If the building engineer on eleventh floor notify the FLS Director that he spotted smoke, what are the responses that the FLS Director must perform?**

Refer to Chapter 11 of this booklet. In general, before the FDNY arrives, the FLS Director must perform every necessary step mentioned in Section 11.4 of the booklet. When the FDNY arrives, the FLS Director must assist the FDNY by arranging required pathway, staff, equipment and documents for the FDNY use. The FLS Director also needs to report all required information to the FDNY (refer to Section 11.5 of the booklet). Before the FDNY leave, the FLS Director must reset the fire alarm system when authorized by the FDNY.

**12.2.2 Tropicana Casino Hotel fire, Atlantic City, NJ (1999)**

(This section was cited from the following resources:

Fire Engineering Magazine, <http://www.fireengineering.com/articles/print/volume-157/issue-6/features/greaseduct-fire-leads-to-stricter-code-enforcement.html> ;  
<https://www.abcofire.com/hood-cleaning-cycle/>;

NFPA "Structure Fires in Eating and Drinking Establishments." <http://www.nfpa.org/news-and-research/firestatistics-and-reports/fire-statistics/fires-by-property-type/assemblies/eating-and-drinking-establishments>)

On March 31, 1999, the Atlantic City Fire Department was dispatched to a fire in the kitchen of the Tropicana

Casino Hotel. The fire was reported in the late evening. The officer reported a fire on the fourth-floor roof of the Tropicana Hotel as the flames were shooting high into the air. The flames were erupting from its restaurant exhaust fan.

The fire began in the Seaside kitchen in an unattended cooking wok full of vegetable oil. The oil heated to its ignition temperature, and flames spread vertically to the hood plenum and grease filters. The fire easily penetrated the filter and spread across the grease-laden interior plenum and proceeded up the exhaust duct to the roof two floors above. The Tropicana Casino Hotel is a fully protected property with automatic sprinkler systems, an automatic fire alarm, and kitchen range-hood fire suppression systems. However, the fire moved so quickly that it did not provide sufficient heat to activate the fire suppression system's fusible link initially. The fusible link was located just past the duct collar outlet on the opposite side of the plenum. The fire extended into the greasy duct and traveled up to the fan housing on the fourth-floor roof.

The fire suppression system finally operated when firefighters placed a hoseline in the roof fan, driving a burst of heat back down at the fusible link. When the heat released the fusible link, the system nozzle above the wok did not operate because it was heavily covered with oil and grease. By the termination of the incident, the

Atlantic City Fire Department had used four hoselines from the building standpipe to bring the fire under control.

Fortunately, no one was seriously injured, but the fire caused over \$350,000 in damage and several weeks of down-time while extensive repairs were made to the building.

**What are the major issues in this Tropicana Casino Hotel fire?**

---

---

---

---

**What could have prevented this fire from becoming catastrophic?**

---

---

---

---

**If the FLS Director in the hotel is notified that there is a fire emergency in the kitchen, what are the responses that the FLS Director must perform?**

Refer to Chapter 11 of this booklet. In general, before the FDNY arrives, the FLS Director must perform every necessary step mentioned in Section 11.4 of the booklet. When the FDNY arrives,

the FLS Director must assist the FDNY by arranging required pathway, staff, equipment and documents for the FDNY use. The FLS Director also needs to report all required information to the FDNY (refer to Section 11.5 of the booklet). The FLS Director must silence and reset the fire alarm system when authorized by the FDNY.

### **12.3 Shopping mall fire**

#### **12.3.1 Ycuá Bolaños supermarket fire, Asuncion, Paraguay. (2004)**



(This section was cited from the following resources:

<http://www.sfgate.com/news/article/At-least-256-die-in-Paraguay-blast-fire-2736865.php>

<http://www.nfpa.org/news-and-research/publications/nfpa-journal/2004/november-december-2004>

<http://idighardware.com/wordpress/wp-content/uploads/2013/11/NFPA-Deadly-Fires-Handout.pdf>)

On August 1<sup>st</sup> of 2004, a two-story, unsprinklered Paraguayan supermarket and commercial complex, which included a restaurant, offices, and an underground parking garage, caught fire. The two floors of the supermarket had approximately 43,000 square feet of floor area for each floor.

Witnesses said an explosion took place about noon in a basement food-court kitchen where families had gathered for lunch in the modern, mall-sized market. The cause was believed to be a faulty barbecue chimney that leaked hot flammable gases into the ceiling, which ignited. The flames burst through the upper face of the duct, then ignited the foam roof. There was no evidence that the fire alarm system provided the required notification. In fact, none of the witnesses reported having heard the fire alarm system during the fire. The fire alarm system was not monitored by a central station at the time of the fire, even though the panel was capable of communicating to a central station.

The fast growing fire caused the 1<sup>st</sup> floor to collapse. Firefighters had to knock holes in walls of neighboring houses to access the supermarket. The fire burned for seven hours before firefighters were able to extinguish it.

The exit doors did not swing outward. In addition, a security guard tried to prevent customers from leaving the building by closing the doors, allegedly to keep people from leaving without paying. The gate separating the ramp for the supermarket carts from the parking area is also closed. This action blocked people trying to flee the fire.

This fire killed more than 300 people and injured nearly 500 people.



**What are the major issues in this Ycuá Bolaños supermarket fire?**

---

---

---

---

---

---

---

**What could have prevented this fire from becoming catastrophic?**

---

---

---

---

---

---

---

**If the FLS Director is informed that there is a fire spreading out from the food-court of the supermarket, what are the responses that the FLS Director must perform?**

Refer to Chapter 11 of this booklet. In general, before the FDNY arrives, the FLS Director must perform every necessary step mentioned in Section 11.4 of the booklet. When the FDNY arrives, the FLS Director must assist the FDNY by arranging required pathway, staff, equipment and documents for the FDNY use. The FLS Director also needs to report all required information to the FDNY (refer to Section 11.5 of the booklet). Before the FDNY leave, the FLS Director must reset the fire alarm system when authorized by the FDNY.

## **12.4 Club fire**

### **12.4.1 Station Nightclub fire, West Warwick, RI. (2003)**

(This section was cited from: NIST NCSTAR 2: Vol. I, Report of the Technical Investigation of The Station Nightclub Fire, NIST, U.S. Department of Commerce: <http://fire.nist.gov/bfrlpubs/fire05/PDF/f05032.pdf>)

A fire occurred on the night of Feb. 20, 2003, in The Station nightclub, at West Warwick, Rhode Island. A band that was on the platform that night, during its performance, used pyrotechnics that ignited polyurethane foam insulation lining the walls and ceiling of the platform. The fire spread quickly along the walls and ceiling area over the dance floor. Smoke was

visible in the exit doorways in a little more than one minute, and flames were observed breaking through a portion of the roof in less than five minutes. Egress from the nightclub, which was not equipped with sprinklers, was hampered by crowding at the main entrance to the building. More than two-thirds of the 462 people in attendance were either killed or injured (100 dead, 230 injured)





**What are the major issues in the Station Nightclub fire?**

---

---

---

---

---

---

---

---

**What could have prevented this fire from becoming catastrophic?**

---

---

---

---

---

---

---

---

**What should the response of an on-duty FLS Director be when there is a fire occurring in a public assembly area of his/her premises?**

Refer to Chapter 11 of this booklet. In general, before the FDNY arrives, the FLS Director must perform every necessary step mentioned in Section 11.4 of the booklet. When the FDNY arrives, the FLS Director must assist the FDNY by arranging required pathway, staff, equipment and documents for the FDNY use. The FLS Director also needs to report all required information to the FDNY (refer to Section 11.5 of the booklet). Before the FDNY leave, the FLS Director must reset the fire alarm system when authorized by the FDNY.

## **12.5 Hospital fire**

### **12.5.1 Southside Regional Medical Center fire, Petersburg, VA. (1994)**

(This section was cited from: U.S. Fire Administration/Technical Report Series, Hospital Fire Kills Four Patients Southside Regional Medical Center, Petersburg, Virginia, USFA-TR-080/December 1994. <https://www.usfa.fema.gov/downloads/pdf/publications/tr-080.pdf>)

On December 31, 1994, a New Year's Eve fire at the Southside Regional Medical Center (SRMC) in Petersburg, Virginia, killed four patients and injured three firefighters and several nurses. The fire was the worst in terms of number of lives lost in a single incident in Petersburg.

The fire originated in a patient room on the fourth floor of the hospital shortly after 9 p.m. Local investigators believe that smoking materials were involved in the ignition and that the fire resulted from the patient's actions. They could not determine if the actions which caused the fire were accidental or intentional. Foam plastic padding in the mattress fueled the fire further. A nurse discovered the fire but was unable to extinguish it. She called for help and pulled the fire alarm but was unable to rescue the patient. She did not close the door to the room of origin which allowed smoke to fill the corridor very quickly.

Within a few minutes after discovery of the fire, smoke conditions became very bad. Three patients in rooms adjacent to the fire room died from smoke inhalation, and one patient in the fire room died from a combination of smoke inhalation and burns.

At some point during the fire, the oxygen regulator on the wall in the room of origin melted and may have released a flow of 100 percent oxygen into the room for a short period until it was shut off. A maintenance worker shut off the central oxygen valve in the elevator lobby area approximately three to five minutes after the alarm sounded, but before the fire department arrived on the fourth floor.

The fire was reported to the Petersburg 9-1-1 Communications Center by several different sources almost simultaneously at 21:11. Twelve minutes after dispatch of the call, and only nine minutes after the fire department's arrival on the scene, they were able to gain control of the fire very quickly.

**What are the major issues in this hospital fire?**

---

---

---

---

---

**What could have prevented this fire from becoming catastrophic?**

---

---

---

---

---

**When the FLS Director is notified by the manual pull station alarm, what are the responses that the FLS Director must perform?**

Refer to Chapter 11 of this booklet. In general, before the FDNY arrives, the FLS Director must perform every necessary step mentioned in Section 11.4 of the booklet. When the FDNY arrives, the FLS Director must assist the FDNY by arranging required pathway, staff, equipment and documents for the FDNY use. The FLS Director also needs to report all required information to the FDNY (refer to Section 11.5 of the booklet). Before the FDNY leave, the FLS Director must reset the fire alarm system when authorized by the FDNY.

## Appendix A: Reference Material

**These Reference Guide will be given to you by the FDNY examiners when taking the FLS Director Computer Test at the Fire Department.**

### Certificate of Fitness/Certificate of Qualification List

Type	Description	Personal/General	Premises Related or Citywide
B-29	Supervision of Battery Systems	General	Premises related
F-01	Citywide Fire Guard for Impairment	Personal	Citywide
F-07/W-07	Fire and Non-Fire Emergency Drill Conductor	Personal	F-07: Premises related W-07: Citywide
F-60	Fire guard for torch operation and fire guard for construction site.	Personal	Citywide
F-89	Fire and Life Safety Director	Personal	Premises related
G-60	Torch operation	Personal	Citywide
P-64/F-64 /W-64	Commercial Kitchen Exhaust System Cleaning Technician	Personal	P-64/W-64: Citywide F-64: Premises related
Q-01/Q-99	Refrigeration system operating engineers	Personal	Premises related
S-12	Citywide Sprinkler System	Personal	Citywide
S-13	Standpipe System (except multi-zone system)	Personal	Citywide
S-14	Standpipe System, multi-zone	Personal	Premises related
S-78/F-78	Inspection, Cleaning & Testing Of Smoke Detectors	Personal	S-78: Citywide F-78: Premises related
S-95	Supervision Of Fire Alarm Systems	Personal	Premises related
S-97/S-98	Inspection, Testing and Servicing of Fire Alarm Systems	Personal	Citywide
T-89	Temporary Fire and Life Safety Director	Personal	Premises related
W-97	Fumigation and insecticidal fogging operation	Personal	Citywide
W-96	Portable Fire Extinguisher Servicing	Personal	Citywide

### Duration and Frequency of FLS Staff Training

The Fire Department recommends that the FLS staff participate in the training designed to familiarize them with their duties pursuant to the plan in accordance with the frequency set below:

FLS staff member	Initial training duration		Refresher training duration and frequency	
	Fire safety	Non-fire emergency	Fire safety	Non-fire emergency
Deputy FLS Directors	Require FLS Director C of F	Require FLS Director C of F	<ul style="list-style-type: none"> <li>• 1 hour quarterly for Group A;</li> <li>• 1 hour quarterly for Group R-1 (per shift);</li> <li>• 1 hour annually for all other occupancies</li> </ul>	1 hour semiannually
FLS building evacuation supervisor	2 hours	3 hours		1 hour semiannually
FLS wardens and deputy wardens	1 hour	2 hours		1 hour annually
FLS brigade members	1 hour	2 hours		1 hour annually
All other FLS staff	1 hour	2 hours		1 hour annually

## Fire alarm system

### Certificate of Fitness for fire alarm system

Duties can be performed by C of F Holders		May be performed by	
		S-95/F-89/T-89	S-97/S-98
1.	Daily visual inspections of fire alarm system	Yes	Yes
2.	Maintain the fire alarm log book	Yes	Yes
3.	Program, service, clean, test, repair and/or replace any fire alarm system components	No	Yes

### Certificate of Fitness for smoke detector cleaning and testing

Duties can be performed by C of F Holders		May be performed by		
		S-95/F-89/T-89	S-78/ F-78	S-97/S-98
1.	Smoke detector visual inspection	Yes	Yes	Yes
2.	Smoke detector inspection, testing and cleaning	No	Yes	Yes
3.	Smoke detector maintenance	No	Yes	Yes
3.	Program, service, clean, test, repair and/or replace fire alarm components	No	No	Yes

## Visual Inspection and Testing Frequencies of Fire Alarm Systems

1. Visual inspection frequencies of each fire alarm component	
Components	
<b>Weekly</b>	
Control equipment: fire alarm systems UNMONITORED for alarm, supervisory and trouble signals (including fuses, interfaced equipment, lamps and LEDs, primary (main) power supply)	
<b>Monthly</b>	
Batteries: Lead-acid	
Batteries: Primary (dry cell)	
<b>Quarterly</b>	
Initiating devices: Radiant energy fire detectors	
Initiating devices: Supervisory signal devices	
Initiating devices: Waterflow devices	
<b>Semiannually</b>	
Batteries: Nickel-cadmium	
Batteries: Sealed lead-acid	
Fire alarm control unit trouble signals	
In-building fire emergency voice/alarm communications equipment	
Remote annunciators	
Initiating devices:	
- Air sampling	
- Duct detectors	
- Electromechanical releasing	
- Fire extinguishing system(s) or suppression system(s) switches	

<b>1. Visual inspection frequencies of each fire alarm component</b>	
<b>Components</b>	
- Manual fire alarm boxes	
- Heat detectors	
- Smoke detectors (excluding one- and two-family dwellings)	
Supervising Station Fire Alarm Systems	
- Transmitters: DACT	
- Transmitters: DART	
- Transmitters: McCulloh	
- Transmitters: RAT	
Special procedures	
Public emergency alarm reporting system transmission equipment	
-Publicly accessible alarm box	
-Master box- manual operation	
Mass notification system, NON-SUPERVISED systems installed prior to adoption of the NFPA 72, 2010 edition	
-Control equipment: Fuses	
-Control equipment: Interfaces	
-Control equipment: Lamp/LED	
-Control equipment: Primary (main) power supply	
-Secondary power batteries: Lead-acid	
-Secondary power batteries: Nickel-cadmium	
-Secondary power batteries: Primary (dry-cell)	
-Secondary power batteries: Sealed lead-acid	
-Initiating devices	
-Notification appliances	
Guard's tour equipment	
<b>Semiannually</b>	
Combination systems : Fire extinguisher electronic monitoring device/systems	
Combination systems: Carbon monoxide detectors/systems	
Interface equipment	
Alarm notification appliances-supervised	
Exit marking audible notification appliances	
<b>Annually</b>	
Control equipment: fire alarm systems MONITORED for alarm, supervisory, and trouble signals (including fuses, interfaced equipment, lamps and LEDs, primary (main) power supply)	
Fiber-optic cable connections	
Public emergency alarm reporting system transmission equipment	
-Auxiliary box	
-Master box- auxiliary operation	
Mass notification system, SUPERVISED	
-Control equipment: Fuses	
-Control equipment: Interfaces	
-Control equipment: Lamp/LED	
-Control equipment: Primary (main) power supply	
-Secondary power batteries: Lead-acid	
-Secondary power batteries: Nickel-cadmium	
-Secondary power batteries: Primary (dry-cell)	

<b>1. Visual inspection frequencies of each fire alarm component</b>
<b>Components</b>
-Secondary power batteries: Sealed lead-acid
-Initiating devices
-Notification appliances
Mass notification system: Antenna
Mass notification system: Transceivers

<b>2. Test frequencies of each fire alarm components</b>
<b>Components</b>
<b>Daily</b>
Public emergency alarm reporting systems: Power supply: Wired system-voltage tests
<b>Weekly</b>
Public emergency alarm reporting systems: Engine-driven generator
<b>Monthly</b>
Batteries-fire alarm systems: Primary type (dry cell)-Age test
<b>Quarterly</b>
Control equipment: building systems NOT connected to a supervising station (including Functions, fuses, interfaced equipment, lamps and LEDs, primary (main) power supply, and transponders)
Public emergency alarm reporting systems: Power supply
-Lead-acid type batteries- Discharge test(2 hours)
-Lead-acid type batteries- Load voltage test
-Nickel-cadmium type batteries- Load voltage test
-Sealed lead-acid type batteries- Load voltage test
Initiating devices: Supervisory signal devices
Pressure supervisory indicating devices
-Water level supervisory indicating devices
-Water temperature supervisory indicating devices
-Room temperature supervisory indicating devices
-Other suppression system supervisory indicating devices
<b>Semiannually</b>
Batteries-fire alarm systems:
- Lead-acid type- Discharge test (30 minutes)
- Lead-acid type- Load voltage test
- Lead-acid type- Specific gravity
- Nickel-cadmium type- Load voltage test
- Sealed lead-acid type- Load voltage test
Public emergency alarm reporting systems: Power supply: Lead-acid type batteries- Specific gravity
Initiating devices:
- Radiant energy fire detectors
- Supervisory signal devices: Valve supervisory switches
- Waterflow devices
Public emergency alarm reporting system transmission equipment:
- Public accessible alarm box
- Master box-manual operation

## 2. Test frequencies of each fire alarm components

### Components

Mass notification system, NON-SUPERVISED systems installed prior to adoption of the NFPA 72, 2010 edition

- Control unit functions and no diagnostic failures are indicated
- Audible/visible functional test
- Secondary power
- Verify content of prerecorded messages
- Verify activation of correct prerecorded message based on a selected event
- Verify activation of correct prerecorded message based on a targeted event
- Verify control unit security mechanism is functional

### Annually

Control equipment: building systems connected to a supervising station (including Functions, fuses, interfaced equipment, lamps and LEDs, primary (main) power supply, and transponders)

Batteries- Fire alarm systems:

- Lead-acid type- Charger test (replace battery as needed)
- Nickel-cadmium type- Charger test (replace battery as needed)
- Nickel-cadmium type- Discharge test (30 minutes)
- Sealed lead-acid type- Charger test (replace battery within 5 years after manufacture or more frequently as needed)
- Sealed lead-acid type- Discharge test (30 minutes)

Public emergency alarm reporting systems: Power supply

- Lead-acid type batteries-Charger test (replace battery as needed)
- Nickel-cadmium type batteries-Charger test (replace battery as needed)
- Nickel-cadmium type batteries-Discharge test (2 hours)
- Sealed lead-acid type batteries-Charger test (replace battery within 5 years after manufacture or more frequently if needed)
- Sealed lead-acid type batteries-Discharge test (2 hours)

Fiber-optic cable power

Control unit trouble signals

In-building fire emergency voice/alarm communications equipment

Remote annunciators

Initiating devices:

- Duct detectors
- Electromechanical releasing
- Fire extinguishing system(s) or suppression system(s) switches
- Fire-gas and other detectors
- Manual fire alarm boxes
- Heat detectors
- System smoke detectors- functional test
- Single- and multiple- station heat alarms
- Single- and multiple- station smoke alarms (in other than one- and two-family dwellings)
- Other supervisory initiating devices

Guard's tour equipment

## 2. Test frequencies of each fire alarm components

<b>Components</b>
Combination systems: Fire extinguisher electronic monitoring device/ systems
Combination systems: Carbon monoxide detectors/systems
Interface equipment and emergency control functions (i.e., fan control, smoke damper operation, elevator recall, elevator power shutdown, door holder release, shutter release, fail-safe system, etc.)
Special hazard equipment
Alarm notification appliances:
- Audible devices
- Audible textual notification appliances
- Visible devices
Exit marking notification appliances
Public emergency alarm reporting system transmission equipment:
- Auxiliary box
- Master box-Auxiliary operation
Supervising station alarm systems-transmitters
<b>Annually</b>
Special procedures
Mass notification system- protected premises, SUPERVISED
Control unit functions and no diagnostic failures are indicated
Audible/visible functional test
Secondary power
Verify content of prerecorded messages
Verify activation of correct prerecorded message based on a selected event
Verify activation of correct prerecorded message based on a targeted event
Verify control unit security mechanism is functional
Mass notification system- wide-area
Control unit functions and no diagnostic failures are indicated
Control unit reset
Control unit security
Audible/visible functional test
Software backup
Secondary power
Antenna
Transceivers
Verify content of prerecorded messages
Verify activation of correct prerecorded message based on a selected event
Verify activation of correct prerecorded message based on a targeted event
Verify control unit security mechanism is functional



## Smoke detectors

All smoke detectors connected to a defined fire alarm system must be

- a. **cleaned** at least once every 6 months, except for analog (intelligent) smoke detectors, which must be cleaned no later than one week from receipt of an indication of the need for cleaning.
- b. tested for smoke entry at least once a year.
- c. tested for sensitivity at least once a year, except for analog (intelligent) smoke detectors, which must be tested for sensitivity no later than one week from receipt of an indication of the need for such testing.

## Sprinkler systems

### Spare sprinkler heads

A stock of spare sprinklers (not less than 6) must be kept on the premise where the temperature does not exceed 100 Degrees F and must include all types and ratings installed in the protected facility and provided as follows:

1-300 sprinklers **six**.

301 - 1000 sprinklers **twelve**.

Over 1000 sprinklers **twenty-four**.

### Individuals authorized to perform tasks

There are certain periodic visual inspections, maintenance, and tests required by the Fire Code that the S-12/S-15 Certificate of Fitness holder may perform, and some that they cannot without additional qualifications (refer to S-12/S-15 FDNY Certificate of Fitness booklet). The table below provides details of the qualifications required for individuals perform various tasks:

	Holding S-12/S-15 only	Q-01 holding S-12/S-15	Master Plumber holding S-12/S-15	Master Fire Suppression Piping Contractor holding S-12/S-15
Visual inspections	Yes	Yes	Yes	Yes
Perform <u>limited</u> maintenance and test of sprinkler system components (refer to the S-12/S-15 booklet for the detail)	No	Yes	Yes	Yes
Test, maintain and repair/replace all sprinkler systems components, but limited to residential occupancies 30 sprinkler heads or less without a booster pump.	No	No	Yes	Yes
Test, maintain and repair/replace all sprinkler systems components	No	No	No	Yes

**The FLS Directors with S-12/S-15 C of F are only authorized to conduct visual inspections of a standpipe system.**

# Test Frequency of Sprinkler Systems

C of F	Certificate of Fitness for (S-12) or (S-15).
Engineer	Refrigeration Operating Engineer (Q-01 or Q-99), NYC High Pressure Operating Engineer, NYS High Pressure Operating Engineer with S-12 C of F (For employees of a single or multiple properties under common ownership employed by the same building owner/management company)
MFSPC	Master Fire Suppression Piping Contractor License (A or B) with S-12 or S-15 C of F.
MP	Master Plumber License (MP) with S-12 or S-15 C of F.

<sup>1</sup> Limited to residential occupancies 30 sprinkler heads or less without booster pump.  
<sup>2</sup> S-95 Supervision for Fire alarm Systems & other related systems.  
<sup>3</sup> Record must be maintained to be checked annually.  
<sup>4</sup> Must be performed once annually by licensed contractor.  
\* Foam-Water Sprinkler Systems ONLY.  
\*\* Water Spray Fixed Systems ONLY.

Test frequency requirements for sprinkler system components					
Components		May be performed by			
		C of F	Engineer	MFSPC	MP <sup>1</sup>
<b><u>QUARTERLY (4)</u></b>					
Alarm Devices	water motor gong	No	Yes	Yes	Yes <sup>1</sup>
Water Spray system test**		No	No	Yes	Yes
<b><u>SEMIANNUALLY (2)</u></b>					
Alarm Devices (Vane type water flow devices)		No	Yes	Yes	Yes <sup>1</sup>
Pressure Switch Type		No	Yes	Yes	Yes <sup>1</sup>
<b><u>ANNUALLY (1)</u></b>					
Antifreeze solution		No	No	Yes	Yes <sup>1</sup>
Flushing**		No	No	Yes	Yes
Complete foam-water system(s)*		No	No	Yes	Yes
Foam-water solution*		No	No	Yes	Yes
<b><u>5 YEARS</u></b>					
Gauges - Remove & send for calibration test or replace as required		No	Yes <sup>3</sup>	Yes	Yes <sup>1</sup>
Sprinklers - Remove send for extra high temperature test and replace as required		No	No	Yes	Yes <sup>1</sup>
<b><u>10 years &amp; every 10 yrs. thereafter</u></b>					
Sprinklers - Dry type		No	No	Yes	Yes <sup>1</sup>
<b><u>20 years &amp; every 10 yrs. thereafter</u></b>					
Sprinklers – fast response and residential		No	No	Yes	Yes <sup>1</sup>
<b><u>50 years &amp; every 10 years after</u></b>					
Sprinklers (Standard Response)		No	No	Yes	Yes <sup>1</sup>
<b><u>B. Fire, Booster and Special Service Pumps</u></b>					
<b><u>WEEKLY (52)</u></b>					
Pump operation - No-flow condition		No	Yes	Yes	Yes <sup>1</sup>
Diesel Engine system	tank float switch	No	Yes	Yes	Yes <sup>1</sup>
	Solenoids valve operation				
<b><u>MONTHLY (1)</u></b>					

<b>Test frequency requirements for sprinkler system components</b>						
<b>Components</b>			<b>May be performed by</b>			
			<b>C of F</b>	<b>Engineer</b>	<b>MFSPC</b>	<b>MP<sup>1</sup></b>
Fire pump – Electric pump (minimum of 10 minutes)			No	Yes	Yes	Yes <sup>1</sup>
Electrical system <sup>2</sup>	Isolating switch & circuit breaker		No	Yes <sup>3</sup>	Yes	Yes <sup>1</sup>
Battery system	Specific gravity or state of charge					
<b><u>SEMIANNUALLY (2)</u></b>						
Electrical system <sup>2</sup>	Operating manual starting means (electrical)		No	Yes <sup>3</sup>	Yes	Yes <sup>1</sup>
Diesel Engine System	Cooling system	Antifreeze protection level	No	Yes <sup>3</sup>	Yes	Yes <sup>1</sup>
	Fuel	Tank float switch				
		Solenoids valve operation				
Electrical system	Operation of safeties and alarms					
<b><u>ANNUALLY (1)</u></b>						
Pump operation - Flow condition			No	No	Yes	No
Electrical system <sup>2</sup>	Trip circuit breaker (if mechanism provided)		No	No	Yes	No
	Operate emergency manual starting means (without power)					
Exhaust system	Excessive back pressure		No	No	Yes	No
Diesel Engine System	Tank vents and overflow piping unobstructed		No	No	Yes	No
<b><u>C. Water Storage Tank</u></b>						
<b><u>MONTHLY (12)</u></b>						
Temperature alarms (cold weather)			No	Yes <sup>4</sup>	Yes	Yes <sup>1</sup>
High temperature limit switches (cold weather)			No	Yes <sup>4</sup>	Yes	Yes <sup>1</sup>
<b><u>SEMIANNUALLY (2)</u></b>						
Water level alarms			No	Yes <sup>4</sup>	Yes	Yes <sup>1</sup>
<b><u>5 YEARS</u></b>						
Level indicators			No	No	Yes	Yes <sup>1</sup>
Pressure gauges			No	No	Yes	Yes <sup>1</sup>
<b><u>D. Valve and Valve Component</u></b>						
<b><u>QUARTERLY (4)</u></b>						
Main drain (sole water supply is through a backflow preventer and/or pressure reducing valves)			No	Yes <sup>4</sup>	Yes	Yes <sup>1</sup>
Water-Flow Alarms (pertaining to dry valves, pre-action, and deluge valves)			No	Yes <sup>4</sup>	Yes	Yes <sup>1</sup>
Foam concentrate strainer(s)*			No	No	Yes	Yes
Pre-action and deluge valves	Priming water		No	Yes <sup>4</sup>	Yes	Yes <sup>1</sup>
	Low/high air pressure alarm					
Dry pipe valves and Quick Opening devices	Priming water		No	Yes <sup>4</sup>	Yes	Yes <sup>1</sup>
	Low/high air pressure alarm					
	Quick-opening devices					
<b><u>SEMIANNUALLY (2)</u></b>						
Control Valves Tamper Switch	Supervisory Alarm		No	Yes <sup>4</sup>	Yes	Yes <sup>1</sup>
Water flow alarms	Vane-type and pressure Switch-type water-flow devices		No	Yes <sup>4</sup>	Yes	Yes <sup>1</sup>
<b><u>ANNUALLY (1)</u></b>						
Main drain			No	No	Yes	Yes <sup>1</sup>
Preaction and deluge valves	Full flow		No	No	Yes	Yes <sup>1</sup>
Dry pipe valves and Quick Opening devices	Trip test		No	No	Yes	Yes <sup>1</sup>
Control Valves	Position		No	No	Yes	Yes <sup>1</sup>
	Operation					
Pressure reducing and Relief valves	Circulation relief					

<b>Test frequency requirements for sprinkler system components</b>						
<b>Components</b>			<b>May be performed by</b>			
			<b>C of F</b>	<b>Engineer</b>	<b>MFSPC</b>	<b>MP<sup>1</sup></b>
Pressure relief valves			<b>No</b>	<b>No</b>	<b>Yes</b>	<b>Yes<sup>1</sup></b>
Backflow prevention Assemblies/Forward flow test			<b>No</b>	<b>No</b>	<b>Yes</b>	<b>Yes<sup>1</sup></b>
Proportioning system(s)-all*			<b>No</b>	<b>No</b>	<b>Yes</b>	<b>Yes</b>
Manual actuation device(s)*			<b>No</b>	<b>No</b>	<b>Yes</b>	<b>Yes</b>
Backflow preventer(s)*			<b>No</b>	<b>No</b>	<b>Yes</b>	<b>Yes</b>
<b>3 YEARS</b>						
Dry pipe valves and quick opening devices		Full flow trip test	<b>No</b>	<b>No</b>	<b>Yes</b>	<b>Yes<sup>1</sup></b>
Pre-action systems		For air leakage	<b>No</b>	<b>No</b>	<b>Yes</b>	<b>Yes</b>
<b>5 YEARS</b>						
Hydrostatic Test			<b>No</b>	<b>No</b>	<b>Yes</b>	<b>Yes</b>
Pressure reducing & Relief valves		Sprinkler systems	<b>No</b>	<b>No</b>	<b>Yes</b>	<b>Yes<sup>1</sup></b>
		Hose connections				
		Hose racks				

## **Standpipe systems**

### **Individuals authorized to perform tasks**

A multi-zone standpipe system must be continuously under the supervision of an S-14 Certificate of Fitness holder. In other words, if your building has multi-zone standpipe system, there must be at least one S-14 C of F holder that could be continuously supervising this system.

**The FLS Directors with S-13/S-14 C of F are only authorized to conduct visual inspections of a standpipe system.**

The sole FLS Director (without holding an S-13/S-14 C of F) C of F is not authorized to conduct required inspections of a standpipe system; however, the FLS Director must ensure that the standpipe systems are inspected, test and maintained as required frequency by the proper C of F or license holder.

The S-13/S-14 C of F holders with different qualifications are permitted to carry different level of responsibilities in inspecting, testing and maintaining the standpipe systems:

<b>Standpipe system (without multi-zone)</b>	<b>Holding S-13 only</b>	<b>Q-01 holding S-13</b>	<b>Master Plumber holding S-13</b>	<b>Master Fire Suppression Piping Contractor holding S-13</b>	
				<b>Holding S-14 only</b>	<b>Q-01 holding S-14</b>
Visual inspections	Yes	Yes	Yes		Yes
Perform <u>limited</u> maintenance and test of standpipe system components (refer to the S-13/S-14 booklet for detail)	No	Yes	Yes		Yes
Test, maintain and repair/replace all standpipe systems that are NOT combined with sprinkler systems	No	No	Yes		Yes
Test, maintain and repair/replace all standpipe systems components that are combined with sprinkler systems	No	No	No		Yes
<b>Multi-zone standpipe system</b>				<b>Holding S-14 only</b>	<b>Q-01 holding S-14</b>
Visual inspections				Yes	Yes

Perform <u>limited</u> maintenance and test of standpipe system components (refer to the S-13/S-14 booklet for detail)	No	Yes
Test, maintain and repair/replace all standpipe systems that are NOT combined with sprinkler systems	No	No
Test, maintain and repair/replace all standpipe systems components that are combined with sprinkler systems	No	No

## Test Frequency of Standpipe Systems

<b>C of F</b>	<b>Certificate of Fitness S-13 City Wide Standpipe System.</b>
<b>Engineer</b>	Refrigeration Operating Engineer (Q-01 & Q-99), NYC High Pressure Operating Engineer, NYS High Pressure Operating Engineer with S-13 C of F (For employees of a single or multiple properties under common ownership employed by the same building owner/management company)
<b>MFSPC</b>	<b>Master Fire Suppression Piping Contractor License (A or B) with S-13 C of F.</b>
<b>MP</b>	<b>Master Plumber License (MP) with S-13 C of F.</b>
<sup>1</sup> Must have an S-12 or S-15 Certificate. <sup>2</sup> S-95 Supervision for Fire Alarm Systems & other related systems. <sup>3</sup> Follow testing requirement. <sup>4</sup> Record must be maintained to be checked annually. <sup>5</sup> Must be performed once annually by licensed contractor.	

Test frequency requirements for standpipe system components					
Components		May be performed by			
		C of F	Engineer	MFSPC	MP
<b>Frequency</b>					
<b>A. Standpipe Systems</b>					
<b>QUARTERLY (4)</b>					
Alarm Devices	Water flow alarms	Yes	Yes	Yes	Yes
	Supervisory devices	Yes	Yes	Yes	Yes
<b>SEMIANNUALLY (2)</b>					
Alarm Devices (Vane Type and Pressure Type water flow devices)		Yes	Yes	Yes	Yes
<b>5 YEARS</b>					
Gauges - Remove and send for calibration test or replace as required		No	Yes <sup>4</sup>	Yes	Yes
<b>B. Fire, Booster and Special Service Pumps</b>					
<b>WEEKLY (52)</b>					
Diesel Pump operation - No-flow condition		No	Yes	Yes	Yes
Diesel Engine system	Solenoids valve operation	No	Yes	Yes	Yes
	Fuel				
	Tank float switch				
	Solenoids valve operation				
<b>MONTHLY (1)</b>					
Electric Fire pump - (minimum of 10 minutes)		No	Yes	Yes	Yes
Electrical system <sup>2</sup>	Isolating switch & circuit breaker	No	Yes	Yes	Yes
Battery system	Specific gravity or state of charge				
<b>SEMIANNUALLY (2)</b>					
Electrical system <sup>2</sup>	Operate manual starting means (electrical)	No	Yes <sup>4</sup>	Yes	Yes
Diesel Engine System	Cooling system				
	Antifreeze protection level	No	Yes	Yes	Yes

	Electrical system	Operation of safeties and alarms				
<b>ANNUALLY (1)</b>						
Pump operation - Flow condition			No	No	Yes	Yes
Electrical system <sup>2</sup>	Trip circuit breaker (if mechanism provided)		No	No	Yes	Yes
	Operate emergency manual starting means (without power)					
Exhaust system	Excessive back pressure		No	No	Yes	Yes
Diesel Engine System	Tank vents and overflow piping unobstructed		No	No	Yes	Yes
<b>C. Water Storage Tank</b>						
<b>MONTHLY (12)</b>						
Temperature alarms (cold weather)			No	Yes <sup>5</sup>	Yes	Yes
High temperature limit switches (whenever the heating system is in service)			No	Yes <sup>5</sup>	Yes	Yes
<b>SEMIANNUALLY (2)</b>						
Water level alarms			No	Yes <sup>5</sup>	Yes	Yes
<b>5 YEARS</b>						
Level indicators			No	Yes <sup>5</sup>	Yes	Yes
Pressure gauges			No	Yes <sup>5</sup>	Yes	Yes
<b>D. Valve and Valve Component</b>						
<b>QUARTERLY (4)</b>						
Main drain (where the sole water supply is through a backflow preventer and/or pressure reducing valves)			No	Yes	Yes	Yes <sup>1</sup>
Dry pipe valves and quick opening devices	Priming water		No	Yes <sup>5</sup>	Yes	Yes
	Low air pressure alarm					
	Quick-opening devices					
<b>SEMIANNUALLY (2)</b>						
Control Valves Tamper Switch	Supervisory Alarm		No	Yes <sup>5</sup>	Yes	Yes
<b>ANNUALLY (1)</b>						
Hose Nozzle (NFPA 1962)			No	No	Yes	Yes
Hose Storage device, racks (NFPA 1962)			No	No	Yes	Yes
Standpipe – hose valve (Class I and Class III)			No	Yes	Yes	Yes
Main drain			No	No	Yes	Yes <sup>1</sup>
Dry pipe valves and Quick opening devices		Trip test	No	No	Yes	Yes
Control Valves	Position		No	No	Yes	Yes
	Operation					
Pressure reducing & Relief valves	Circulation relief		No	No	Yes	Yes
	Pressure relief valves					
Backflow prevention Assemblies			No	No	Yes	Yes
<b>3 YEARS</b>						
Hose 1962			No	Yes	Yes	Yes
Dry pipe valves and quick opening devices	Full flow trip test		No	No	Yes	Yes
	Pressure reducing valve flow test					
<b>5 YEARS</b>						
Hose			No	Yes	Yes	Yes
Hydrostatic Test			No	No	Yes	Yes
Standpipe system full flow test			No	No	Yes	Yes
Gauges - Remove and send for calibration test or replace as required			No	Yes <sup>4</sup>	Yes	Yes

## Non-water fire extinguishing systems summary table

Systems	Commonly found in/with	Monthly visual inspection	Test, service and maintenance	
			Qualified personnel	Minimum frequency requirement
Dry chemical fire extinguishing systems	flammable liquid storage rooms and at motor fuel dispensing areas.	required	A licensed master fire suppression piping contractor properly trained and having knowledge of the installation, operation and maintenance of the specific system.	semiannual
Wet chemical fire extinguishing systems	commercial cooking system	required		semiannual
Foam systems	commercial cooking system	required to be conducted by a S-15 COF holder		annual
Carbon dioxide fire extinguishing system	flammable liquid storage rooms and at motor fuel dispensing areas.	required		semiannual
Clean agent fire extinguishing systems	IT systems, data storage rooms and manufacturing equipment, or irreplaceable items	required		semiannual
Halon fire extinguishing systems		required		semiannual
Water mist fire extinguishing systems	computer rooms or other energized electrical equipment areas	required		annual

## Smoke control system

### Inspection, Maintenance and Testing

Fire Code requires that smoke control systems be maintained in good working order. It requires a written maintenance program, including periodic inspection and testing, to be established and implemented immediately upon installation of the smoke control system. Operational testing of the smoke control system must include all of the system's components including initiating devices, fans, dampers, controls, doors and windows.

### Frequency

- Dedicated smoke control systems:
  - must be tested semiannually
- Non-dedicated smoke control systems:
  - must be tested annually.
- Post –fire smoke purge systems:
  - must be tested periodically
  - periodic inspection
  - maintained according to manufacturers' recommendations.

# Emergency power System

## Individuals authorized to perform tasks

Fire Code requires that the inspection, testing and other maintenance of emergency power systems be conducted under the supervision of a person having one of the following qualifications:

- A person holding a Certificate of Fitness as a Fire and Life Safety Director.
- A person holding a Q-01 Certificate of Qualification.
- An electrician licensed by the Department of Buildings.
- An electrician holding a special license issued by the Department of Buildings.
- A person holding a stationary engineer license, or high-pressure boiler operating engineer's license, issued by the Department of Buildings.
- A registered design professional.

## Periodic inspection and testing requirements

### NFPA Standard 110

Chapter 8 of NFPA Standard 110 includes requirements for the periodic inspection, testing and other maintenance of emergency power systems supplied by emergency generators. Emergency power systems subject to compliance with the requirements of NFPA Standard 110, as modified by FC Appendix B must be maintained as follows:

- Storage batteries, including electrolyte levels or battery voltage, must be inspected weekly and maintained in full compliance with the manufacturer's specifications. Lead- acid batteries must include the monthly testing and recording of electrolyte specific gravity.
- Emergency power systems, including all related components, must be inspected weekly and exercised under load monthly.
- Emergency generator sets must be tested monthly for a minimum of 30 minutes under operating temperature conditions and at not less than 30 percent of the emergency power system nameplate kilowatt rating, or under loading that maintains the minimum exhaust gas temperatures as recommended by the manufacturer. Instructions must be provided for safe manual transfer in the event automatic transfer switches malfunction.
- Diesel-powered emergency power system installations that do not meet the requirements of generator set monthly exercise as noted above must be tested monthly with the available emergency power system load and exercised annually with supplemental loads at 25 percent of nameplate rating for 30 minutes, followed by 50 percent of nameplate rating for 30 minutes, followed by 75 percent of nameplate rating for 60 minutes, for a total of 2 continuous hours.
- Transfer switches must be tested semiannually. The semiannually test of a transfer switch must consist of electrically operating the transfer switch from the standard position to the alternate position and then returning back to the standard position.
- Level 1 emergency power systems must be tested every 3 years for at least 4 hours under its running load. A full facility power outage is not intended for this test, but is recommended where a facility power outage has not occurred within the last 36 months.
- Emergency power systems must be maintained to ensure to a reasonable degree that the system is capable of supplying service within the time specified for both the type and the class. The



maintenance procedure and frequency should conform to the manufacturer's recommendations. In the absence of such recommendations, Figure A.8.3.1(a) of NFPA Standard 110 suggests periodic (weekly, monthly, quarterly, semiannually and annually) visual inspection, checking, changing components, cleaning and testing of the following:

- Fuel.
- Lubrication system.
- Cooling system.
- Exhaust system.
- Battery system.
- Electrical system.
- Prime mover.
- Generator.
- General conditions of emergency power systems (any unusual condition of vibration, leakage, noise, temperature or deterioration), and service room or housing housekeeping.
- Restore systems to automatic operation condition.

#### **NFPA Standard 111**

Stored electrical energy emergency power systems subject to compliance with the requirements of NFPA Standard 111 must be maintained as follows:

- Equipment must be inspected monthly and tested quarterly under connected load for a minimum of 5 minutes. The monthly inspection must include the following:
  - Battery and associated charger/control equipment must be checked to verify that they are in a clean and satisfactory condition.
  - Battery electrolyte levels, individual cell voltages and specific gravity must be checked.
  - Conditions of the plates and sediment of free-electrolyte, lead-acid batteries in transparent containers must be checked.
  - A load test must be performed and the output voltage, the battery voltage, and the duration of the test must be recorded at the beginning and end of the test for each battery set.
  - All indicator lamps, meters, and controls must be checked to verify that they are operating correctly.
- Stored emergency power systems must be checked annually at full load for time duration as specified in NFPA Standard 111.
- Transfer switches must be tested semiannually.
- A regular maintenance and testing program must be established. The maintenance procedure and frequency should conform to the manufacturer's recommendations. In the absence of such recommendations, Table A.8.3.2 of NFPA Standard 111 suggests periodic (weekly, monthly, quarterly, semiannually and annually) visual inspection, checking, changing components, cleaning and testing of the following:
  - Battery.
  - Energy conversion equipment.
  - Battery charger.
  - Load current (check quarterly).
  - Transfer switch (tested semiannually).

## Certificate of Fitness, Certificate of Qualification, Company Certification and FDNY Permit requirements

Topics	Required C of F or C of Q	Required Company Certification	FDNY Permit Required
<b>Module 1: Primary Fire Protection Systems</b>			
Sprinkler system	S-12/S-15	No	No
Standpipe system	S-13/S-14	No	No
Fire Alarm system	S-95/FLSD: Visual inspection	No	No
	S-78/F-78: inspection & cleaning of smoke detectors	Smoke detector company	
	S-97/S-98: install, repair, servicing fire alarm system	Smoke detector company or Central station company	
Fire guard for out-of-service fire protection system	F-01	No	No
<b>Module 2: Other Fire Safety-Related Building Systems</b>			
Refrigerating system	Q-01	No	Yes
Emergency power system	Q-01 or FLSD or other licensed professionals listed in the emergency power system section of this material.	No	Yes <sup>a</sup>
Battery system	B-29	No	No
Elevators-in-readiness	No	No	No
Non-water fire extinguishing systems	No <sup>b</sup>	No	No
Means of egress	No	No	No
Commercial cooking system	P-64/F-64/W-64	Commercial Cooking Exhaust System	Yes
<b>Module 3: Other Fire Safety Operational and Maintenance Requirements</b>			
Hot work operations	G-60: Torch operation F-60: Fire guard for torch operation	No	Yes
Fumigation and insecticidal fogging operation	W-97	Fumigation and Thermal Insecticidal Fogging Operation	No
Storage, use & display of decorations	No	No	No
Emergency planning & preparedness	FLSD (F-89/T-89)	No	No
Portable fire extinguishers	W-96	Portable Fire Extinguisher Servicing	No

- i. Emergency power system operating on fuel oil requires an FDNY permit for oil storage.
- ii. Foam fire extinguishing system must be supervised by an S-15 C of F holder

## Logbook entry requirements

- FLS staffing

Identification of the FLS Director and deputy FLS director(s) (name and C of F number), availability of FLS staff members on duty each day or shift during regular business hours.

Any FLS staff changes, FLS on-site examinations, amendments, and date of the plan acceptance by the FDNY.

- Daily entries

The name of the person who made the entry, the Certificate of Fitness number of the FLS director on duty, and the time each tour of duty began and ended, must be entered in the FLS log book on a daily basis.

- Fire incidents and any implementation of FDNY plan

- (1) Date and time of the occurrence of any activation of the fire alarm system or any fire-related incident.
- (2) Location of the alarm activation and activated detector type
- (3) Any implementation of the fire safety and evacuation plan.

Entries must be made of any evacuation, partial evacuation or other implementation of the fire safety and evacuation plan, including the affected floors, in-building relocation areas to which they were directed or other directions given.

- (4) Any notifications to the FDNY or other agencies
- (5) Responding department unit and officer

- Fire alarm system off-line entries

If the fire alarm is taken off-line, the following entries should be made:

- (1) Date and time off-line
- (2) Name and C of F number of the person who took off-line
- (3) Reason off-line
- (4) Central station name, phone number of the central station, name and the C of F number (or ID number) of the operator
- (5) Date and time restored

- Non-fire emergency incidents and any implementation of FDNY plan

- (1) Date and time of the occurrence of any non-fire emergency incident.
- (2) Any implementation of the non-fire emergency action plan.

Entries must be made of any evacuation, partial evacuation, in-building relocation, shelter-in-place, or other implementation of the emergency action plan, including the affected floors, in-building relocation areas to which they were directed or other directions given.

- (3) Any notifications to the FDNY or other agencies
- (4) Responding department unit and officer

- Drills

The record of each drill that is conducted must be included in the FLS logbook. It is recommended to include the following information:

- (1) the date and time of the drill;

- (2) the person(s) conducting the drill, including the Certificate of Fitness number of any drill conductor;
- (3) the FLS staff members participating in the drill;
- (4) date and time that required notifications (to Department and other agencies) were made, and persons receiving such notifications
- (5) identification of the floors or other areas of the building or occupancy, and the number of building occupants participating in the drill;
- (6) the type of drill conducted (fire or non-fire emergency, and indicate type of scenario, if applicable, and/or stairway familiarization)
- (7) the special needs addressed;
- (8) the problems encountered;
- (9) if an evacuation drill was conducted, the weather conditions and time required to accomplish the evacuation; and
- (10) an outline of the drill content.

The drill conductor, if not a member of the emergency preparedness staff of the building or occupancy, must maintain a record of each drill, the location of each presentation, the problems encountered, and an outline of the drill content.

- FLS staff training

- (1) the date of training session;
- (2) the person(s) conducting the training session, the person's Certificate of Fitness number;
- (3) the persons attending the training session; and
- (4) the type of training session conducted (live or computerized instruction).

- Fire alarm, sprinkler, standpipe and emergency power systems

The FLS logbook should include the record of any inspection, test, and maintenance of fire alarm, sprinkler, standpipe, emergency power systems. The entries should include

- (1) The date, the name, Certificate of Fitness or other license number of any contractor responsible for inspecting, testing and/or otherwise maintaining the building's sprinkler and standpipe systems.
- (2) The job type (inspection, maintenance or test)
- (3) The frequency requirement (daily, weekly, monthly, etc.)
- (4) Condition found and any action taken regarding to the condition
- (5) Out-of-service record:
  - Date and time
  - Description of condition, affected areas
  - Notification for out of service and the person receiving the notification
  - Action taken
  - Date and time restored
  - Notification for restoring
  - Responsible impairment coordinator

- Phase I and Phase II elevator operations

The FLS logbook should include the record of any test of phase I and phase II elevator operations. The entries should include

- (1) The date of testing,
- (2) person who performed the test: Indicate the name and number of the Certificate of Fitness holder (if applicable) or other building personnel (by job title) or a contractor (title and company name).
- (3) condition found and any action taken regarding to the condition.
- (4) The elevator keys have been verified to be located in approved location.

- Smoke control systems

The FLS logbook should include the record of any inspection and test of dedicated and/or non-dedicated smoke control systems. The entries should include:

- (1) The Date of the inspection/test
- (2) Name of the person who performs the inspection/test
- (3) Job type (inspection/test)
- (4) Normal power/ emergency power
- (5) Condition found and any action taken regarding to the condition

- Commercial cooking equipment systems

Indicate the name and number of the Certificate of Fitness holder (if applicable) or other building personnel (by job title). If inspection, testing or other maintenance is to be performed by a contractor, indicate as much in the plan, and identify the contractor in the FSP logbook.

- FLS staff on-site examinations

The FLS logbook should include the record of any on-site exam taken place in the premises. The entries should include:

- (1) The on-site exam type
- (2) Date and time of the on-site exam
- (3) Name of the candidate who took the exam
- (4) Name of the FDNY inspector who administered the exam